

Programmable Relay ZEN V2 Units

CSM_ZEN_DS_E_5_4

Even Broader Applications with Increased Functionality and Higher Precision

- Increased functionality in a compact body (70 mm wide × 90 mm high).
- Easy programming is available using the LCD and operation buttons. (See note 1.)
- This single Unit easily provides relay, timer, counter, and time switch functions.
- Expansion is easy with Expansion I/O Units, allowing up to 44 I/O points. (See note 2.)
- Economy-type and Communications-type CPU Units have been added to series.
- Improved Weekly Timers (See note 1.)
Increased timing accuracy with a monthly deviation of ± 15 s max. Multiple-day operation and pulse output operation have been added.
- Select from two power supply options:
100 to 240 VAC or 12 to 24 VDC.

Note: 1. Not supported for ZEN-□C2□□-□-V2 models.
2. When using CPU Units with 20 I/O points.

The information in this document applies to V2 Units.
Refer to page 28 for details on differences with previous products.



UL US CE **NEW**

 Refer to *Safety Precautions* on page 33

Features

■ Easy and Simple Programming for Automatic Small-scale Control

Saves Space, Wiring, and Installation Steps

- Versatile functionality in a compact body (70 mm wide × 90 mm high).
- This single Unit easily provides relay, timer, counter, and time switch functions. Wiring work is greatly reduced because separate wiring is not required for devices such as timers and counters.

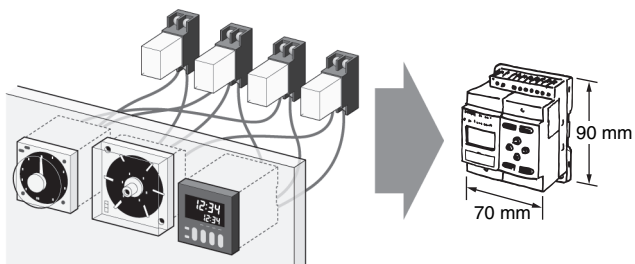

Easy Programming

The LCD screen comes with 8 operation buttons on the front panel to enable programming in ladder view format. The LCD screen also has a backlight, making it easier to see when the ZEN is used in dark locations.

Note: Not supported for ZEN-□C2□□-□-V2 models.

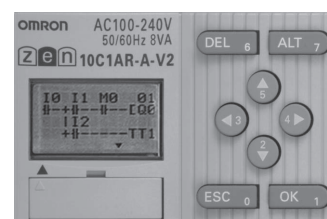

Flexible Expansion Enables Up to 44 I/O Points

Up to three Expansion I/O Units can be connected if there are not enough I/O points. Expansion I/O Units are only 35 mm wide.

Note: CPU Units with 10 I/O points can be expanded to 34 I/O points. Expansion I/O Units cannot be connected to Economy-type CPU Units.

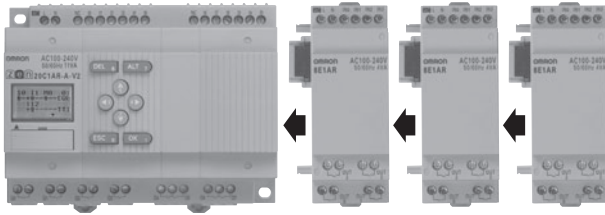

Support Software with Simulation Function

- Programs can be easily written, saved, and monitored by personal computer.
- Programs can be simulated on the personal computer without connecting to the ZEN.

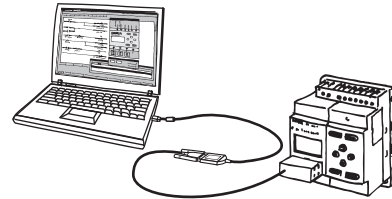

Note: For notebook computers that do not have an RS-232C serial port, connect the computer to the ZEN by connecting an OMRON CS1W-CIF31 USB-Serial Conversion Cable to the ZEN-CIF01 Connecting Cable.

Other Versatile Functions

- Use of a Memory Cassette makes it easy to copy and save programs.
- Equipped with two analog input channels (CPU Units with DC power supply only).
- Password function ensures security. (See note.)
- Multi-language display in six languages (English, Japanese, German, French, Spanish, Italian). (See note.)
- Display user-set messages or analog-converted values. (See note.)

Note: Not supported for ZEN-C2□□-□-V2 models.

Enhanced Features of V2 CPU Units

Improved Weekly Timer and Calendar Timer Functions

Note: Not supported for ZEN-C2□□-□-V2 models.

- The time precision has been increased.
Conventional model: 2-min difference/month
↓
-V2 models: ± 15 -s difference/month (at 25°C)
- Multiple-day operation and pulse-output operation are now possible.
- These improved functions are convenient for time-controlled applications such as lighting and air conditioning control.



Lighting control

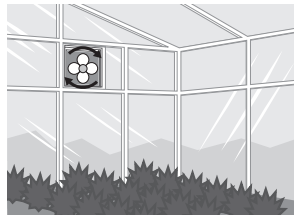

Air conditioning control

Economy-type Added to the Series

- Economy-type CPU Units with a more affordable price have been added to the series, although Expansion I/O Units cannot be added.

12 to 24 VDC Line Voltage Operation

Operation is now possible with 12 VDC.

Expansion I/O Units have been reduced to half-size (35 mm wide).

RS-485 Communications Model Added to Series

Production line conditions can be remotely monitored by monitoring the ZEN control status.

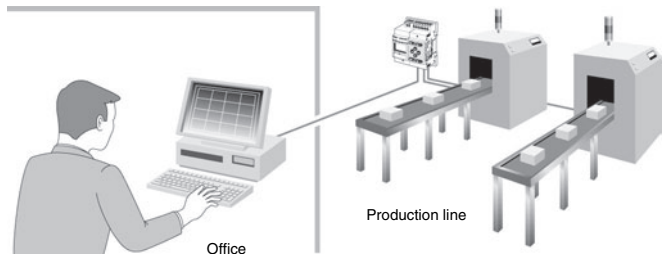

More Precise Analog Input

Conventional model: $\pm 10\%$ FS \rightarrow -V2 models: $\pm 1.5\%$ FS
DC power supply models are equipped with two analog inputs (0 to 10 V). There are four analog comparators. The increased precision makes it even easier to use the Unit in simple control applications with voltage, current, temperature, and other analog values.

8-digit Counter, 150-Hz Counter

- An 8-digit counter and 8-digit comparator have been added.
- The maximum count for DC power supply models is 150 Hz.

Twin-timer Operation Added

Twin-timer operation allows you to set ON and OFF times separately, greatly simplifying intermittent operation.

Series Configuration

CPU Units

Power supply voltage: 100 to 240 VAC, 12 to 24 VDC, Output: Relay, transistor output

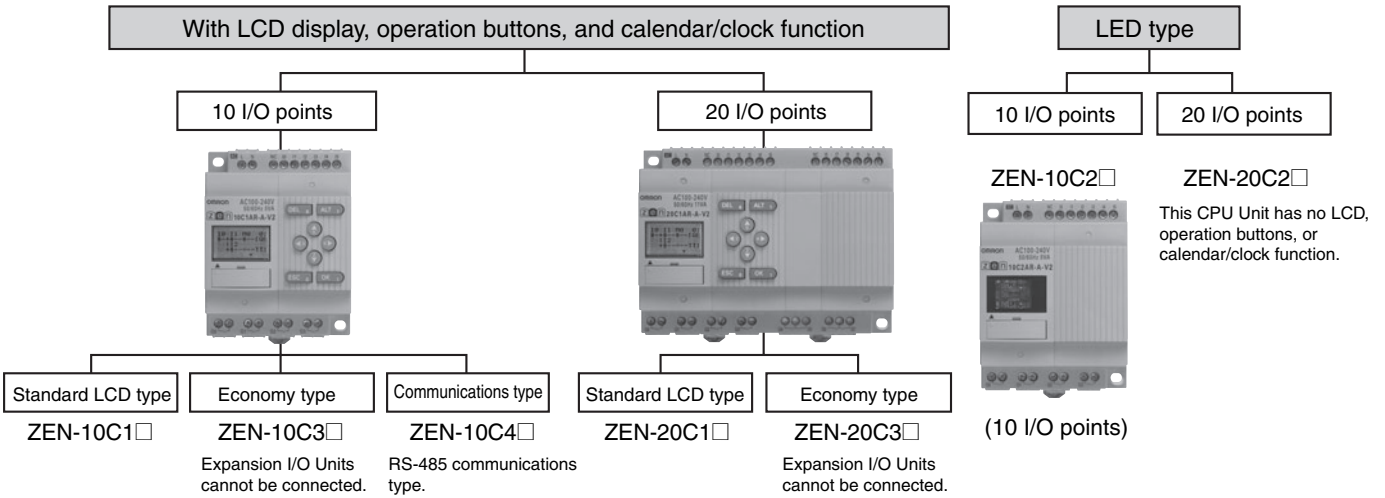

Expansion I/O Units

Only 35-mm wide.
4 input, 4 output points



Power Supply Unit

Same shape and design as ZEN.
24 VDC, 30 W



Support Software

Allows easy programming and operation simulation.



Model Number Structure

■ Model Number Legend

Note: This model number legend includes combinations that are not available.
Please check *List of Models* on page 5 for availability.

CPU Units

ZEN-□C□□□□-□-V2
1 2 3 4 5

1. Number of I/O points

- 10: 6 inputs and 4 outputs (See note.)
- 20: 12 inputs and 8 outputs

2. Type classifier

- 1: Standard LCD type with display
- 2: LED type without display
- 3: Economy type with display
(Expansion I/O Units cannot be connected.)
- 4: Communications type with display

Note: The Communications-type CPU Unit has 6 inputs and 3 outputs.

3. Input type

- A: AC input
- D: DC input

4. Output type

- R: Relay
- T: Transistor

5. Supply voltage

- A: AC power supply
- D: DC power supply

Expansion I/O Units

ZEN-8E1□□
1 2 3 4

1. Number of I/O points

- 8: 4 inputs and 4 outputs

2. Unit version classifier

- E1: Can connect to V2 CPU Units (See note.)

Note: Use a ZEN-8E□□/-4E□ to connect to pre-V1 and V1 CPU Units.

3. Input type

- A: AC input
- D: DC input

4. Output type

- R: Relay
- T: Transistor

This data sheet is provided as a guideline for selecting products. Be sure to refer to the following user manuals for application precautions and other information required for operation before attempting to use the product.

ZEN Operation Manual (Cat. No. Z211)

ZEN Communications Manual (Cat. No. Z212)

ZEN Support Software Operation Manual (Cat. No. Z184-E1-03)

The PDF versions of these manuals can be downloaded from the following website.

ZEN Website <http://www.fa.omron.co.jp>

Ordering Information

List of Models

CPU Units and Expansion I/O Units

| Unit | Name | No. of I/O points | LCD display | Power supply voltage | Inputs | Outputs | Buttons, calendar, and clock | Analog input | Model | | |
|--|--|--|--------------------------------|--------------------------------|--------------------------------|--------------------------------|------------------------------|--------------------------------|-----------------------------|--------------------------------|-----------------|
| CPU Units | Standard LCD type | 10 | Yes | 100 to 240 VAC 12 to 24 VDC | 6 | 100 to 240 VAC 12 to 24 VDC | 4 | Yes | No | ZEN-10C1AR-A-V2 | |
| | | | | | 12 | 100 to 240 VAC 12 to 24 VDC | 8 | | Relays | Yes | ZEN-10C1DR-D-V2 |
| | | | | Transistors | | | | | Yes | ZEN-10C1DT-D-V2 | |
| | | 20 | | 100 to 240 VAC 12 to 24 VDC | 12 | 100 to 240 VAC 12 to 24 VDC | 8 | | Relays | No | ZEN-20C1AR-A-V2 |
| | | | | | | | | | Transistors | Yes | ZEN-20C1DR-D-V2 |
| | | | | Transistors | Yes | ZEN-20C1DT-D-V2 | | | | | |
| | LED type without display (See note 1.) | 10 | No | 100 to 240 VAC 12 to 24 VDC | 6 | 100 to 240 VAC 12 to 24 VDC | 4 | No | No | ZEN-10C2AR-A-V2 | |
| | | | | | 12 | 100 to 240V AC 12 to 24 VDC | 8 | | Relays | Yes | ZEN-10C2DR-D-V2 |
| | | | | Transistors | | | | | Yes | ZEN-10C2DT-D-V2 | |
| | | 20 | | 100 to 240 VAC 12 to 24 VDC | 12 | 100 to 240V AC 12 to 24 VDC | 8 | | Relays | No | ZEN-20C2AR-A-V2 |
| | | | | | | | | | Transistors | Yes | ZEN-20C2DR-D-V2 |
| | | | | Transistors | Yes | ZEN-20C2DT-D-V2 | | | | | |
| Economy type (Expansion I/O Units cannot be connected) | 10 | Yes | 100 to 240 VAC 12 to 24 VDC | 6 | 100 to 240 VAC 12 to 24 VDC | 4 | Yes | No | ZEN-10C3AR-A-V2 | | |
| | | | | 12 | 100 to 240 VAC 12 to 24 VDC | 8 | | Relays | Yes | ZEN-10C3DR-D-V2 | |
| | | | 20 | | | | | 100 to 240 VAC 12 to 24 VDC | 12 | 100 to 240 VAC 12 to 24 VDC | 8 |
| | Transistors | | | Yes | ZEN-20C3DR-D-V2 | | | | | | |
| | Transistors | | | Yes | ZEN-20C3DR-D-V2 | | | | | | |
| | Communications type | | 9 | 100 to 240 VAC 12 to 24 VDC | 6 | 100 to 240 VAC 12 to 24 VDC | | 3 | Relays | Yes | No |
| Yes | | ZEN-10C4DR-D-V2 | | | | | | | | | |
| ZEN Kit | | Set containing CPU Unit (ZEN-10C1AR-A-V2), Connecting Cable, ZEN Support Software, and manual. | | | | | | | ZEN-KIT01-EV4 (See note 4.) | | |
| | | Set containing CPU Unit (ZEN-10C1DR-D-V2), Connecting Cable, ZEN Support Software, and manual. | | | | | | | ZEN-KIT02-EV4 (See note 4.) | | |
| Expansion I/O Units | 8 | --- | --- | 100 to 240 VAC | 4 | 100 to 240 VAC | 4 | --- | ZEN-8E1AR (See notes 2, 3.) | | |
| | | | | 12 to 24 VDC | | 12 to 24 VDC | | | ZEN-8E1DR (See note 2.) | | |
| | | | | --- | | Transistors | | | ZEN-8E1DT (See note 2.) | | |

- Note:**
1. Programming is not possible using only the CPU in the LED-type CPU Unit. ZEN Support Software or a Memory Cassette is required.
 2. Cannot be connected to pre-V1 and V1 CPU Units.
 3. The ZEN-8E1AR cannot be connected to a CPU Unit with DC power supply.
 4. Product no longer available to order.

Power Supply Unit

| Power ratings | Input voltage | Output voltage | Output current | Model |
|---------------|----------------|----------------|----------------|-------------|
| 30 W | 100 to 240 VAC | 24 VDC | 1.3 A | ZEN-PA03024 |

- Note:** Product no longer available to order.
Refer to the *ZEN-PA03024 Datasheet* (Cat. No. L103) for detailed specifications.

Accessories (Order Separately)

| Name | Specifications | Remarks | Model | | |
|-----------------------------|---|---|--|----------|---|
| Memory Cassette | EEPROM (for data security and copying) | Enables programs and parameter settings to be saved or copied to another ZEN. (See note 1.) | | ZEN-ME01 | |
| | | | LCD-type CPU Unit with display (See note 2.) | | LED-type CPU Unit without display (See note 3.) |
| | | Transfer from ZEN to Memory | Supported | | Not supported |
| | | Transfer from Memory Cassette to ZEN | Supported | | Automatic transfer when power turned ON |
| | | Memory Cassette initialization | Supported | | Not supported |
| Connecting Cable | 2 m RS-232C (9-pin D-sub connector) | For notebook computers that do not have an RS-232C serialport, connect the computer to the ZEN by connecting an OMRON CS1W-CIF31 USB-Serial Conversion Cable to the ZEN-CIF01 Connecting Cable. | ZEN-CIF01 | | |
| USB-Serial Conversion Cable | 0.5m USB (type A plug, male), RS-232C (D-sub 9-pin, male) | Attached drivers (On CD-ROM) | CS1W-CIF31 | | |
| Battery Unit | 10 years min. Battery life (at 25°C) | Ladder programs and parameter settings are saved to the CPU Unit EEPROM but calendar, clock, and holding timer bits and holding timer/counter present values are held by the capacitor. Therefore, if the power supply is interrupted for 2 days or more (at 25°C), this data will be reset. Use a Battery Unit for systems where the power supply may be interrupted for long periods. | ZEN-BAT01 | | |
| ZEN Support Software | Runs on Windows 95, 98, 2000, Me, XP, NT4.0 Service Pack3, Vista (32bit), Windows7 (32-bit/64-bit version), Windows10 (32-bit/64-bit version) | Specifically designed for the ZEN (CD-ROM). | ZEN-SOFT01-V4 | | |

- Note:**
1. Memory Cassettes created using a CPU Unit can be read to other CPU Units, regardless of which model is used. Restrictions, apply, however, to the functions that can be used, depending on the CPU Unit version combination. For details, refer to *Memory Cassette and CPU Unit Combinations* on page 31.
 2. Standard LCD-type, Economy-type, and Communications-type CPU Units (i.e., excluding ZEN-□C2□□-□-V2 models).
 3. LED-type CPU Unit without display (i.e., ZEN-□C2□□-□-V2 models).

Mounting Accessories (Order Separately)

| Name | Specifications | Model |
|----------------|------------------------|-----------|
| Mounting Track | 50 cm (l) × 7.3 mm (t) | PFP-50N |
| | 1 m (l) × 7.3 mm (t) | PFP-100N |
| | 1 m (l) × 16 mm (t) | PFP-100N2 |
| End Plate | | PFP-M |
| Spacer | | PFP-S |

System Configuration

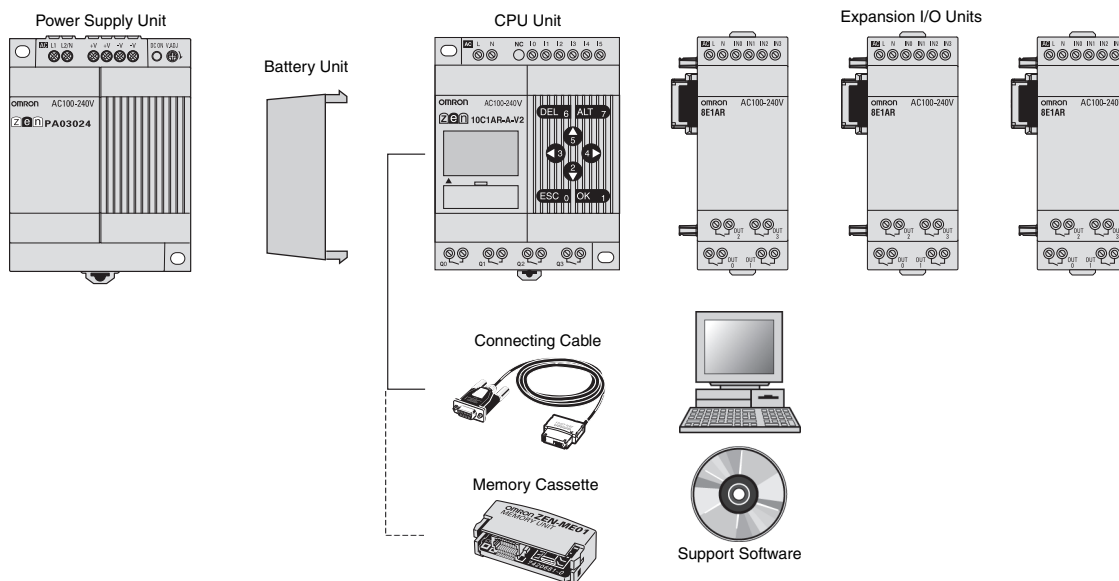

- Note:**
1. Up to 3 Expansion I/O Units can be connected to any type of CPU Unit except for Economy-type CPU Units. Expansion I/O Units with AC Inputs, however, cannot be connected to CPU Units with DC Power Supplies.
 2. The Connecting Cable and Memory Cassette cannot be connected to the ZEN at the same time.
 3. Programs cannot be written to LED-type CPU Units (i.e., ZEN-□C2□□-□-V2 models) without the ZEN Support Software or a Memory Cassette.

Specifications

■ Ratings

| Item | Specification | |
|----------------------------------|--|--|
| | ZEN-□C□AR-A-V2/ZEN-8E1AR | ZEN-□C□D□-D-V2/ZEN-8E1D□ |
| Rated supply voltage | 100 to 240 VAC, 50/60 Hz | 12 to 24 VDC (DC ripple rate: 5% max.) |
| Operating voltage range | 85 to 264 VAC | 10.8 to 28.8 VDC |
| Power consumption | <p>CPU Units without Expansion I/O Units</p> <ul style="list-style-type: none"> ZEN-10C1AR-A-V2/ZEN-10C2AR-A-V2/ ZEN-10C3AR-A-V2 100 V AC: 5 VA max. 240 V AC: 7 VA max. ZEN-10C4AR-A-V2 100 V AC: 6 VA max. 240 V AC: 8 VA max. ZEN-20C□AR-A-V2 100 V AC: 7 VA max. 240 V AC: 10 VA max. <p>CPU Units with three Expansion I/O Units</p> <ul style="list-style-type: none"> ZEN-10C1AR-A-V2/ZEN-10C2AR-A-V2 100 V AC: 6 VA max. 240 V AC: 8 VA max. ZEN-10C4AR-A-V2 100 V AC: 7 VA max. 240 V AC: 9 VA max. ZEN-20C□AR-A-V2 100 V AC: 8 VA max. 240 V AC: 11 VA max. <p>Expansion I/O Units</p> <ul style="list-style-type: none"> ZEN-8E1AR 100 V AC: 3 VA max. 240 V AC: 4 VA max. | <p>CPU Units without Expansion I/O Units</p> <ul style="list-style-type: none"> ZEN-10C□DR-D-V2 12/24 V DC: 3 W max. (ZEN-10C3DR-D-V2: 2.8 W max.) ZEN-10C□DT-D-V2 12/24 V DC: 2 W max. ZEN-20C□DR-D-V2 12/24 V DC: 4 W max. ZEN-20C□DT-D-V2 12/24 V DC: 2 W max. <p>CPU Units with three Expansion I/O Units</p> <ul style="list-style-type: none"> ZEN-10C□DR-D-V2 12/24 V DC: 4 W max. ZEN-10C□DT-D-V2 12/24 V DC: 3 W max. ZEN-20C□DR-D-V2 12/24 V DC: 5 W max. ZEN-20C□DT-D-V2 12/24 V DC: 3 W max. <p>Expansion I/O Units</p> <ul style="list-style-type: none"> ZEN-8E1DR 12/24 V DC: 2 W max. |
| Inrush current | ZEN-10C□AR-A-V2: 4.5 A max. ZEN-20C□AR-A-V2: 4.5 A max. ZEN-8E1AR: 4 A max. | ZEN-10C□D□-D-V2: 30 A max. ZEN-20C□D□-D-V2: 30 A max. ZEN-8E1DR: 15 A max. |
| Ambient temperature | 0 to 55°C (-25 to 55°C for ZEN-□C2□□-□-V2 models) | |
| Ambient storage temperature | -20 to 75°C (-40 to 75°C for ZEN-□C2□□-□-V2 models) | |
| Ambient humidity | 10% to 90% (with no condensation) | |
| Ambient conditions | No corrosive gases | |
| Mounting method | Surface mounting, DIN track mounting (standard (vertical) installation and horizontal installation) (See notes 1 and 2.) | |
| Terminal block | Solid-line terminal block (use solid wire or fine-stranded wire) | |
| Terminal screw tightening torque | 0.565 to 0.6 N·m (5 to 5.3 in·lb) | |
| Degree of protection | IP20 (Mounted inside a control panel) | |

Note: 1. Can be mounted to 35-mm DIN Track.

2. Standard (Vertical) installation Horizontal installation

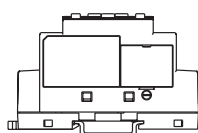
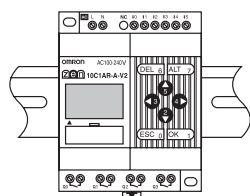

■ Characteristics

| Item | Specification |
|---|---|
| Control method | Stored program control |
| I/O control method | Cyclic scan |
| Programming language | Ladder diagram |
| Program capacity | 96 lines (3 input conditions and 1 output per line) |
| Max. No. of control I/O points | 44 points (See note 1.) CPU Units with 20 I/O points: 12 inputs and 8 outputs Expansion I/O Units: 4 inputs and 4 outputs each, up to 3 Units. |
| LCD display (See note 2.) | 12 characters × 4 lines, with backlight |
| Operation buttons (See note 2.) | 8 (4 cursor buttons and 4 operation buttons) |
| User program backup | Internal EEPROM, Memory Cassette (optional) |
| Power interruption hold | Internal holding bit status, holding timer/counter present values, calendar and clock (year, month, day of month, day of week, time) • Super capacitor backup time: 2 days min. (25°C) • Life of optional battery: 10 years min. (25°C) |
| Calendar and clock function (See note 2.) | Accuracy: ±15 s/month (at 25°C) |
| Timer accuracy | 0.01 s unit: -0.05% -10 ms max. (rate for set value) min/s unit: -0.05% -1 s max. (rate for set value) h/min unit: -0.05% -1 min max. (rate for set value) |
| Maximum counting speed | 150 Hz: 8-Digit counter (F) set to high-speed operations (CPU Units with DC power supplies only) (The counting speed may be less than 150 Hz depending on the cycle time of the program. See page 21.) |
| Insulation resistance | 20 MΩ (at 500 VDC) min.: Between power supply terminals and all output terminals. Between terminals of different output circuits. Between all terminals of CPU Unit and all terminals of Expansion I/O Unit. |
| Insulation | <ul style="list-style-type: none"> • Reinforced insulation Between power supply or input terminals and output terminals. Between terminals of different output circuits. Between all terminals of CPU Unit and all terminals of Expansion I/O Unit. • No separation Between power supply and input terminals of the same unit. Between power supply terminals of CPU Unit and computer connector, Battery Unit connector, or all Expansion Unit connectors (all interfaces are live parts). |
| Dielectric strength | 2,300 VAC, 50/60 Hz for 1 min (leakage current 1 mA max.): Between power supply terminals and all output terminals. Between terminals of different output circuit. Between all terminals of CPU Unit and all terminals of Expansion I/O Unit. |
| Vibration resistance | Conforms to IEC60068-2-6, 5 to 9 Hz with 3.5-mm single amplitude, 9 to 150 Hz acceleration 9.8 m/s ² , 10 sweeps each in X, Y, and Z directions (1 octave/min) |
| Shock resistance | Conforms to IEC60068-2-27, 147 m/s ² , 3 times each in X, Y, and Z directions. |
| Weight | CPU Unit with 10 I/O points: Approx. 300 g max. CPU Unit with 20 I/O points: Approx. 350 g max. Expansion I/O Unit: Approx. 120 g max. |

Note: 1. Up to 34 points for CPU Units with 10 I/O points. With Communications-type CPU Units, however, the CPU Unit has 6 inputs and 3 outputs, for a maximum of 33 I/O points.
2. Not provided for LED-type CPU Unit without display (i.e., ZEN-□C2□□-□-□-□V2 models).

■ Communications Specifications (Communications-type CPU Units)

| Item | ZEN-10C4□R-□-□V2 |
|------------------------|--|
| Communications | RS-485 (two-wire, half duplex) |
| Synchronization method | Start-stop synchronization |
| Baud rate | 4800, 9600, or 19200 bps |
| Transmission code | ASCII |
| Data bit length | 7 or 8 bits |
| Stop bit length | 1 or 2 bits |
| Error detection | Vertical parity (none, even, odd), Block check character (BCC) |
| Flow control | None |
| Interface | RS-485 |
| Retry function | None |
| Node number | 0 to 99 (default: 1), XX (broadcasting) |

Approved Standards

| Item | Specification | | |
|---------------------------|--|--------------|--|
| Safety standards | cULus: UL508/CSA C22.2 No.142 (ZEN-PA03024 take Class I Div2) Conforms to EN/IEC 61131-2 clause 11, excluding 11.7.2.2 (Overvoltage category 2 and Pollution degree II conforms to IEC 60664-1) | | |
| EMC (See note.) | Radiation Field Emission | CISPR11 | Class A, Group 1 |
| | Noise Terminal Voltage Emission | CISPR11 | Class A, Group 1 |
| | Electrostatic Discharge Immunity | IEC61000-4-2 | In air: 8 kV, In contact: 6 kV |
| | Electromagnetic Field Immunity | IEC61000-4-3 | 10 V/m |
| | Electrical Fast Transient/Burst Immunity | IEC61000-4-4 | Power line AC I/O: 2 kV DC I/O: 1 kV |
| | Surge Immunity | IEC61000-4-5 | Normal Noise AC power supply, AC I/O: 1 kV DC power supply, DC I/O: 0.5 kV Common Noise AC power supply, AC I/O: 2 kV DC power supply: 1 kV DC I/O: 0.5 kV |
| | Immunity to Conducted Disturbances Induced by Radio-frequency Fields | IEC61000-4-6 | 3 V |
| | Momentary Power Interruption Immunity | IEC61131-2 | CPU Units with AC Power Supplies: 10 ms max. CPU Units with DC Power Supplies: 2 ms max. (level: PS1) |

Note: EMC conforms to EN 61131-2 clause 8 except in the following cases.

- When Expansion I/O Units with DC inputs are connected to a CPU Unit with an AC power supply, the burst immunity between power supplies will be 1 kv.
- When the signal wire for transistor outputs exceeds 10 m, the surge immunity of DC output signal lines will not conform.

Input Specifications

CPU Units

AC Inputs (Not Isolated)

| Item | Specifications | Circuit drawing |
|--------------------------|---|-----------------|
| Input voltage | 100 to 240 VAC +10%, -15%, 50/60 Hz | |
| Input impedance | 680 kΩ | |
| Input current | 0.15 mA/100 VAC, 0.35 mA/240 VAC | |
| ON voltage | 80 VAC min. | |
| OFF voltage | 25 VAC max. | |
| ON response time | 50 ms or 70 ms at 100 VAC (See note.) | |
| OFF response time | 100 ms or 120 ms at 240 VAC (See note.) | |

Note: Can be selected using the filter settings.

DC Inputs: I0 to I3 for Units with 10 I/O points, I0 to I9 for Units with 20 I/O Points (Not Isolated)

| Item | Specifications | Circuit drawing |
|--------------------------|----------------------------|-----------------|
| Input voltage | 12 to 24 VDC +20%, -10% | |
| Input impedance | 5.3 kΩ | |
| Input current | 4.5 mA (typ.)/24 VDC | |
| ON voltage | 8 VDC min. | |
| OFF voltage | 5 VDC max. | |
| ON response time | 15 ms or 50 ms (See note.) | |
| OFF response time | | |

Note: Can be selected using the input filter settings, except when I0 is being used for an 8-digit counter with a high-speed input.

DC Inputs: I4 and I5 for Units with 10 I/O points, Ia and Ib for Units with 20 I/O Points (Not Isolated)

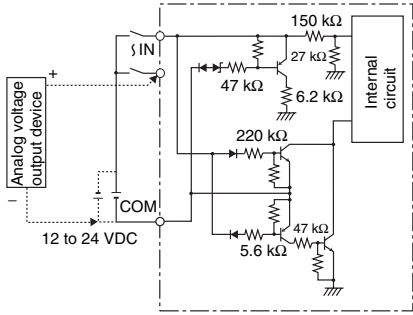
| Item | | Specifications | Circuit drawing |
|---------------|--------------------------|--|--|
| DC Inputs | Input voltage | 12 to 24 VDC +20%, -10% |  |
| | Input impedance | PNP: 5.5 kΩ/14 VDC min. 100 kΩ/14 VDC max. NPN: 5.2 kΩ | |
| | Input current | PNP: 4.3 mA (typ.)/24 VDC NPN: 4.6 mA (typ.)/24 VDC | |
| | ON voltage | 8 VDC min. | |
| | OFF voltage | 3 VDC max. | |
| | ON response time | 15 ms or 50 ms (See note.) | |
| | OFF response time | | |
| Analog Inputs | Input range | 0 to 10 V | |
| | External input impedance | 100 kΩ min. | |
| | Resolution | 0.1 V (1/100 FS) | |
| | Accuracy | ±1.5% FS (at ambient operating temperature within rated range) | |
| | AD conversion data | 0 to 10.5 V (in increments of 0.1 V) | |

Note: Can be selected using the input filter settings.

Expansion I/O Units

AC Inputs (Not Isolated)

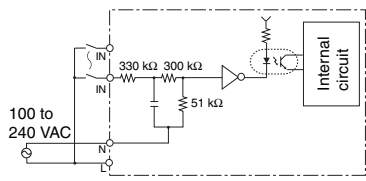
| Item | | Specifications | Circuit drawing |
|-------------------|--|---|--|
| Input voltage | | 100 to 240 VAC +10%, -15%, 50/60 Hz |  |
| Input impedance | | 680 kΩ | |
| Input current | | 0.15 mA/100 VAC, 0.35 mA/240 VAC | |
| ON voltage | | 80 VAC min. | |
| OFF voltage | | 25 VAC max. | |
| ON response time | | 50 ms or 70 ms at 100 VAC (See note.) | |
| Off response time | | 100 ms or 120 ms at 240 VAC (See note.) | |

Note: Can be selected using the input filter settings.

DC Inputs (ZEN-8E1DR: Not Isolated, ZEN-8E1DT: Photocoupler Isolated)

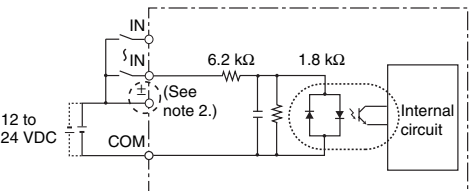
| Item | | Specifications | Circuit drawing |
|-------------------|--|------------------------------|--|
| Input voltage | | 12 to 24 VDC +20%, -10% |  |
| Input impedance | | 6.5 kΩ | |
| Input current | | 3.7 mA (typ.)/24 VDC | |
| ON voltage | | 8 VDC min. | |
| OFF voltage | | 5 VDC max. | |
| ON response time | | 15 ms or 50 ms (See note 1.) | |
| OFF response time | | | |

Note: 1. Can be selected using the input filter settings.

2. The ZEN-8E1DT has no +/- terminals. There is no need to supply power.

Output Specifications (CPU Units and Expansion I/O Units)

Units with Relay Outputs

| Item | Specifications | Circuit drawing | |
|-----------------------------------|---|-----------------|--|
| Maximum switching capacity | 250 VAC/8 A (resistive load: $\cos\phi = 1$) 24 VDC/5 A (resistive load) Use the following values for the total of all outputs. CPU Units with 10 I/O points: 20 A max. (15 A max. for Communications-type CPU Units) CPU Units with 20 I/O points: 40 A max. Expansion I/O Units: 20 A max. | | |
| Minimum switching capacity | 5 VDC/10 mA (resistive load) (failure level: P, reference value) | | |
| Relay life | Electrical | | Resistive load: 50,000 times ($\cos\phi = 1$) Inductive load: 50,000 times ($\cos\phi = 0.4$) |
| | Mechanical | | 10 million times |
| ON response time | 15 ms max. | | |
| OFF response time | 5 ms max. | | |

The life under the worst conditions, of the output contacts used in ZEN relay outputs is given in the above table. Guidelines for the normal life of the relays are shown in the diagram on the right.

Note: The switching capacity, switching durability, and applicable load area when actually using the relay depend on the type of load, environmental conditions, and switching conditions. Therefore, be sure to confirm these conditions for the actual machine before use.

Life-test Curve (Reference Value)

Usage: 360 times/hour

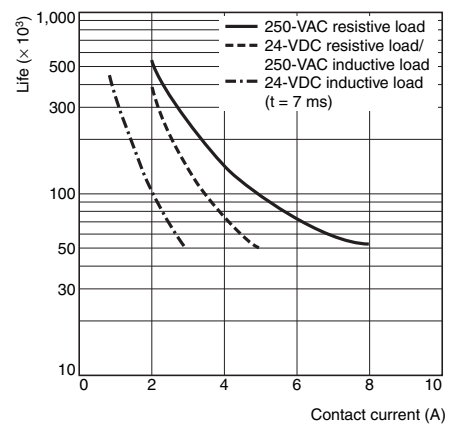

Units with Transistor Outputs

| Item | Specifications | Circuit drawing |
|-----------------------------------|---------------------|--|
| Maximum switching capacity | 24 VDC +20%, 500 mA | <p>Each circuit is configured with an independent common circuit</p> |
| Leakage current | 0.1 mA max. | |
| Residual voltage | 1.5 V max. | |
| ON response time | 1 ms max. | |
| OFF response time | 1 ms max. | |

Connections

■ Input Connections

Units with AC Power Supply

- Note:**
1. Supply power to both the CPU Unit and Expansion I/O Units from the same power supply and turn them ON and OFF at the same time.
 2. The input circuit commons for CPU Units with AC power supply are internally connected to the N terminal of the power supply circuit. Wire the L terminal to the power supply of the input device.
 3. The input circuit commons for Expansion I/O Units with AC power supply are internally connected to the N terminal of the power supply circuit. Wire the L terminal to the power supply of the input device.

CPU Units with 10 I/O Points and Expansion I/O Units

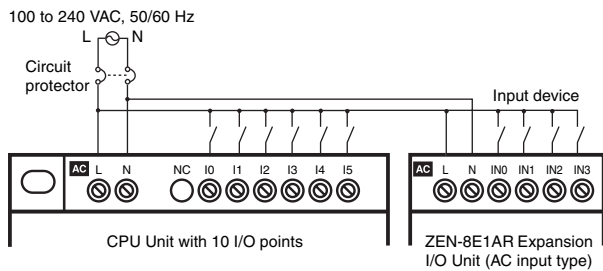

CPU Units with 20 I/O Points and Expansion I/O Units

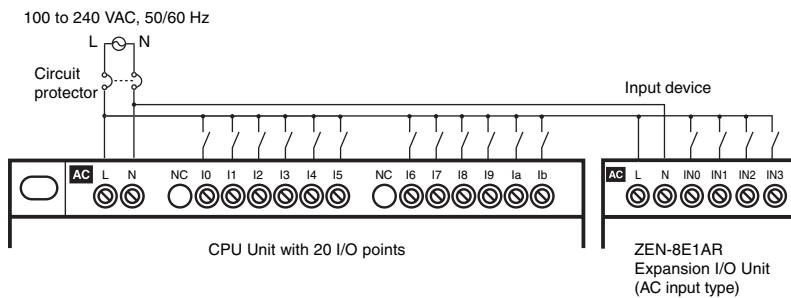

Connecting Expansion I/O Units with DC Inputs

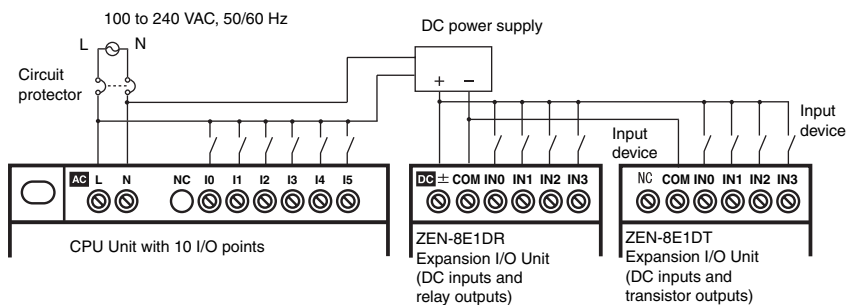

- Note:** When connecting Expansion I/O Units with DC inputs to a CPU Unit with an AC power supply, the burst noise immunity will be 1 kV (IEC 61000-4-4).

Units with DC Power Supply

- Note:** 1. Be sure to connect the COM terminal before turning ON the power supply. If the COM terminal is disconnected, or if the wiring is changed after turning ON the power supply, a malfunction may occur.
2. Apply the power supply voltage through a relay or switch in such a way that the voltage reaches the rated value within 4 s. If the voltage is applied gradually, the power may not be reset or unstable output operations may result.

CPU Units with 10 I/O Points

For Connections to Negative (-) Common (PNP Connection)

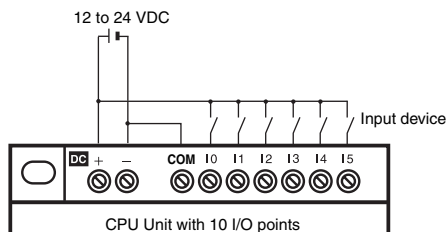

For Connecting Analog Input Devices to Input Terminals I4 and I5

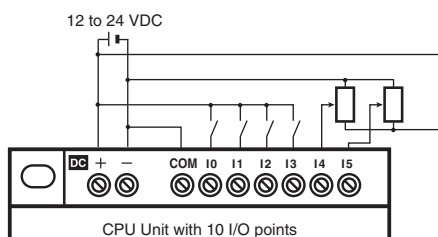

Note: When connecting an analog input device, always connect the negative side to the COM terminal.

For Connections to Positive (+) Common (NPN Connection)

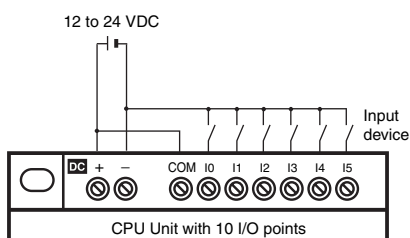

Note: When connected to the positive (+) common, I4 and I5 cannot be used as analog inputs.

CPU Units with 20 I/O Points

For Connections to a Negative Common (PNP Connection)

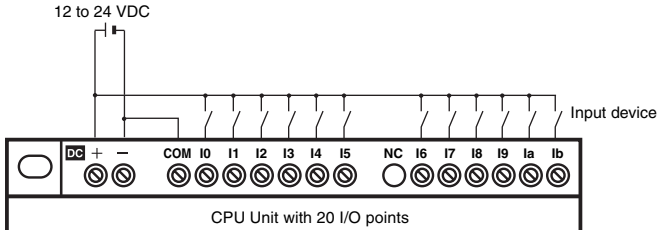

For Connecting Analog Input Devices to Input Terminals Ia and Ib

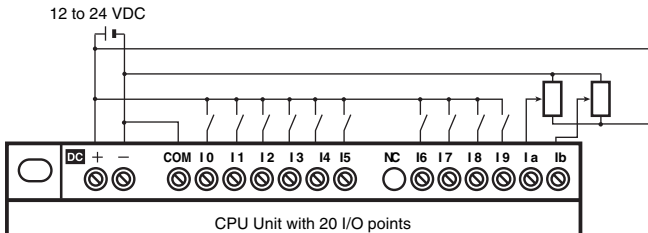

Note: When connecting an analog input device, always connect the negative side to the COM terminal.

For Connections to Positive (+) Common (NPN Connection)

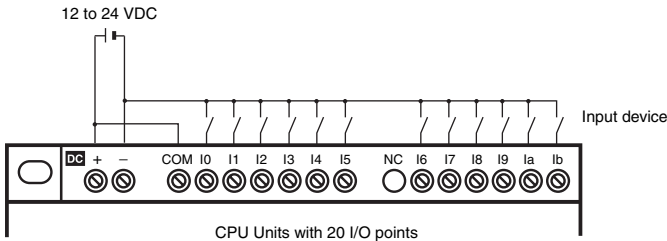

Note: When connected to the positive (+) common, Ia and Ib cannot be used as analog inputs.

Expansion I/O Units

- Note:**
1. Supply power to both the CPU Unit and Expansion I/O Units from the same power supply and turn them ON and OFF at the same time.
 2. ZEN-8E1AR Expansion I/O Units with AC inputs cannot be connected to CPU Units with DC power supply.
 3. The input circuit commons for ZEN-8E1DR Expansion I/O Units with relay outputs are each internally connected to one side of the power supply circuit (COM terminal).
 4. ZEN-8E1DT Expansion I/O Units with transistor outputs do not need to be connected to a power supply.

For Connections to Negative (-) Common

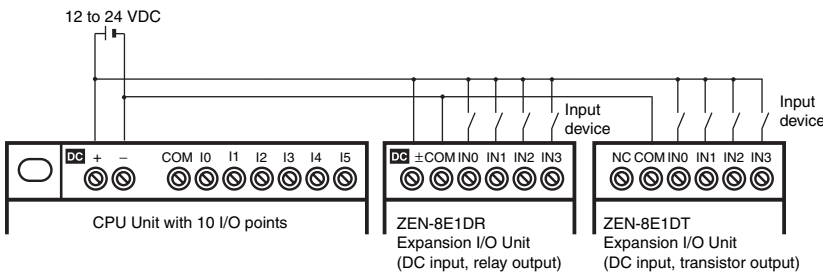

For Connections to Positive (+) Common

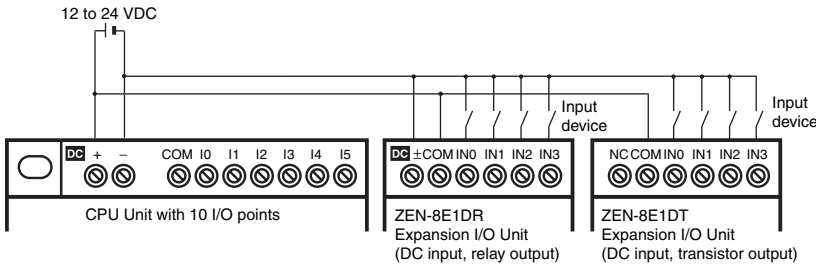

Output Connections

Units with Relay Outputs

All four relay output circuits in both CPU Units with 10 I/O points and Expansion I/O Units have independent contacts. CPU Units with 20 I/O points have 4 independent contacts (Q0 to Q3) and the remaining four (Q4 to Q7) have 2 points/common. There are no restrictions for polarity.

Standard LCD-type CPU Units, LED-type CPU Units, and Economy-type CPU Units

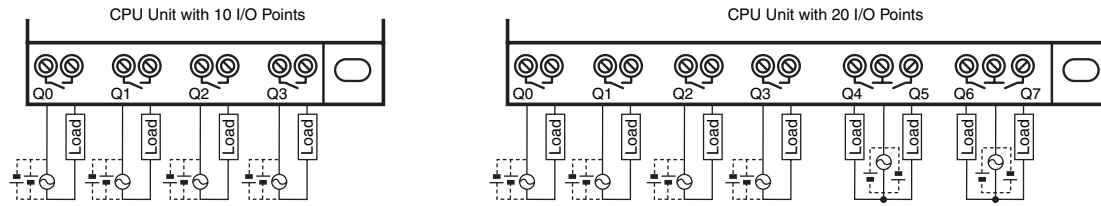

Communications-type CPU Units

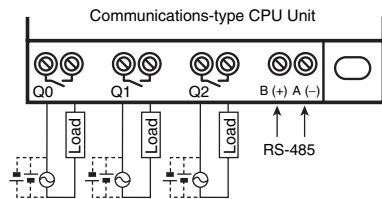

Expansion I/O Units

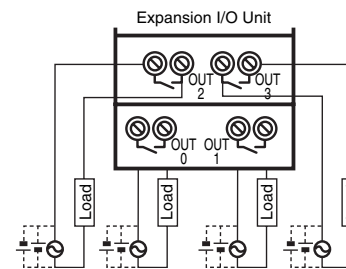

Units with Transistor Outputs

For CPU Units with 10 I/O points and Expansion I/O Units, all 4 outputs in the transistor output circuits have independent circuits. The terminals of output have polarity given on the terminal block, but no problem will result from reversing the connection positions of the power supply and load.

For CPU Units with 20 I/O points, outputs Q0 to Q3 in the transistor output circuits have independent circuits and outputs Q4 to Q7 have 2 points per common. The terminals of output Q0 to Q3 have polarity given on the terminal block, but no problem will result from reversing the connection positions of the power supply and load.

Note: Do not exceed a cable length of 10 m when connecting transistor outputs.

Standard LCD-type CPU Units and LED-type CPU Units without Display

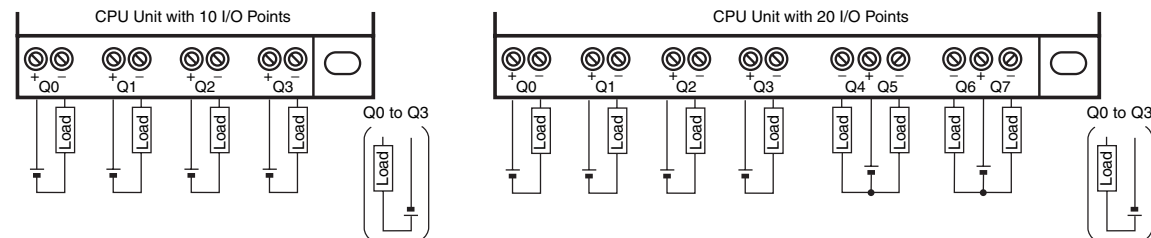

Expansion I/O Units

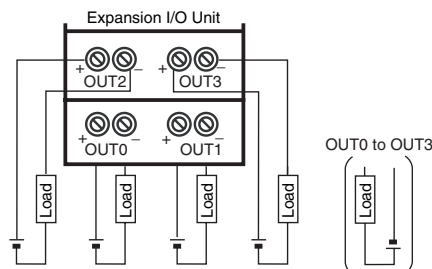

Nomenclature

■ Standard LCD-type, Economy-type, and Communications-type CPU Units (Except for ZEN-□C2□□-□-V2 Models)

CPU Units with 10 I/O Points

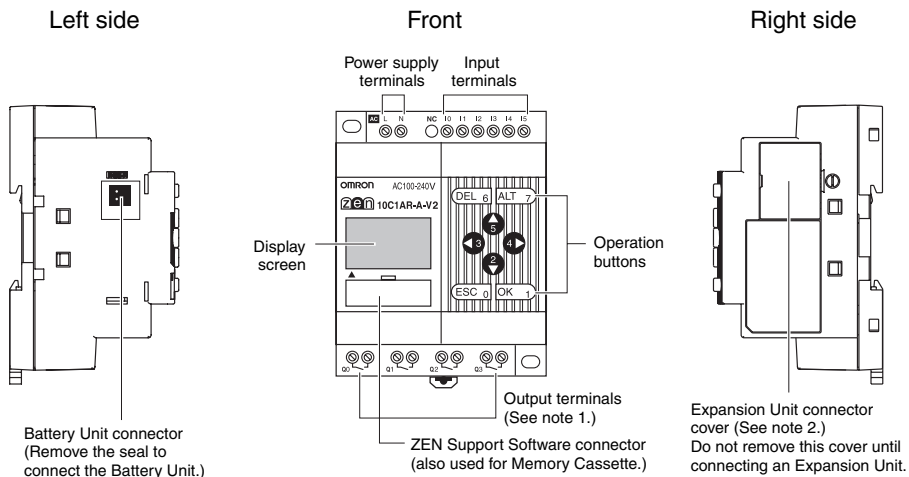

Display Screen



Icon Meanings

| Icon | Meaning |
|------|--|
| RUN | Display while in RUN mode. |
| ERR | Indicates an error. |
| ▲ | Displayed when there is a higher-level menu or ladder program line than the one currently displayed. |
| ▼ | Displayed when there is a lower-level menu or ladder program line than the one currently displayed. |
| 🔑 | Displayed when a password had been set. |

CPU Units with 20 I/O Points

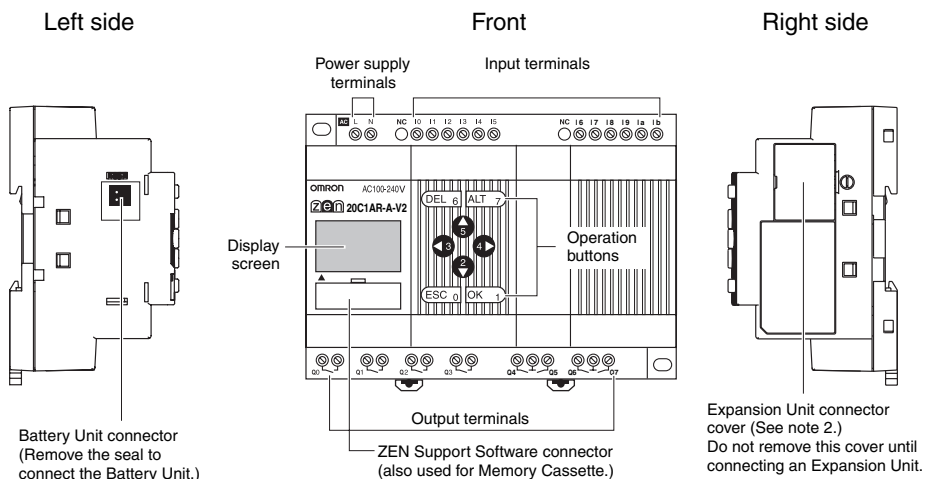

Note: 1. With Communications-type CPU Units, the Q3 terminal is used as the RS-485 terminal. For details, refer to *Output Connections* on page 15.

2. Economy-type CPU Units are not provided with an Expansion Unit connector. Do not remove the cover.

Operation Buttons

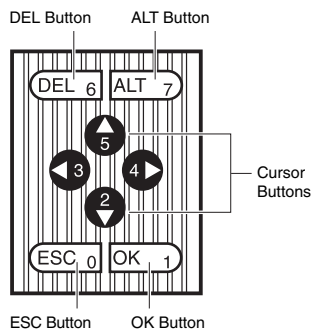

Operation Button Names and Operations

| Button | Function | | | |
|--------------|---|---|---|------------------------------------|
| | Menus | Writing ladder program | Setting parameters | Button input bit (See page 24.) |
| DEL DEL 6 | --- | Deletes inputs, outputs, connection lines, and blank lines. | --- | B6 ON |
| ALT ALT 7 | --- | <ul style="list-style-type: none"> Switches between normally open and normally closed conditions. Changes to connection line write mode. Inserts a line. | --- | B7 ON |
| Up 5 | Moves the cursor up and down. | <ul style="list-style-type: none"> Moves the cursor up and down. Selects bit types and functions. | <ul style="list-style-type: none"> Moves the cursor up and down. Changes numerals and parameters. | B5 ON |
| Down 2 | | | | B2 ON |
| Left 3 | --- | Moves the cursor right and left. | Moves the cursor right and left. | B3 ON |
| Right 4 | | | | B4 ON |
| ESC ESC 0 | Returns to the previous screen. | Cancels the setting and returns to the previous operation. | Cancels the setting and returns to the previous operation. | B0 ON |
| OK OK 1 | Selects the menu item at the cursor position. | Confirms the setting. | Confirms the setting. | B1 ON |

■ LED-type CPU Units without Display (ZEN-□C2□□-□-V2)

CPU Units with 10 I/O Points

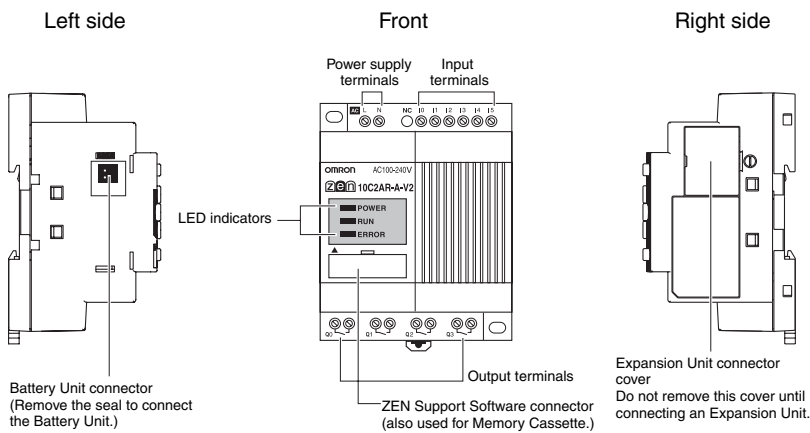

LED Indicators

| Name | LED | Status | |
|-------|-------|---------|-----------------|
| POWER | Green | Lit | Power is ON. |
| | | Not lit | Power is OFF. |
| RUN | Green | Lit | Operating (RUN) |
| | | Not lit | Stopped (STOP) |
| ERROR | Red | Lit | Error occurred. |
| | | Not lit | Normal |

CPU Units with 20 I/O Points

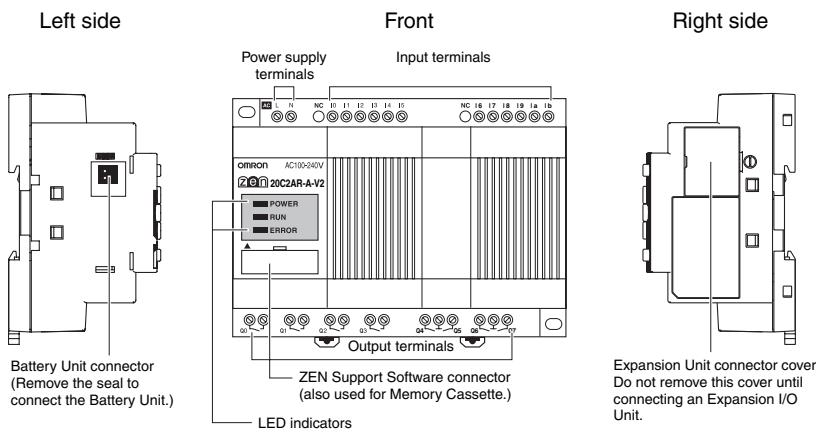

■ Expansion I/O Units (ZEN-8E1□□)

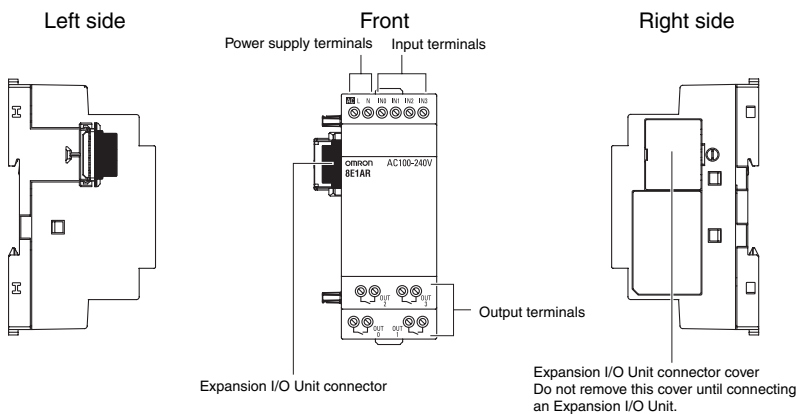

Precaution when Using Expansion I/O Units:

Up to three Expansion I/O Units can be connected.

When removing the Expansion Unit connector cover from the side of the CPU Unit, use a Phillips screwdriver to remove the cover screw, and then insert a flat-blade screw driver in the cover gap to remove the cover, as shown at the right.

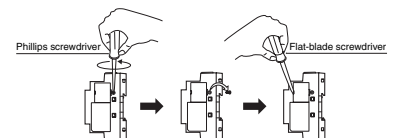

Operation

■ Bits

| Name | Symbol | Bit addresses | No. of points | Operation | | Details (See note 1.) | |
|---------------------------------|--------|---------------------------|---------------|---|--|--|---|
| Input bits | I | I0 to Ib (See note 2.) | 12 | Reflect the ON/OFF status of the input devices connected to the input terminals on the CPU Unit. | | --- | |
| Expansion input bits | X | X0 to Xb | 12 | Reflect the ON/OFF status of the input devices connected to the input terminals on the Expansion I/O Units. | | | |
| Output bits | Q | Q0 to Q7 (See note 2.) | 8 | The ON/OFF status of these output bits is used to control the output devices connected to the output terminals on the CPU Unit. | | 1 | |
| Expansion output bits | Y | Y0 to Yb | 12 | The ON/OFF status of these output bits is used to control the output devices connected to the output terminals on the Expansion I/O Units. | | | |
| Work bits | M | M0 to Mf | 16 | Work bits can be used only within the ZEN program. I/Os for external devices cannot be made (i.e., all I/O is internal). | | | |
| Holding bits | H | H0 to Hf | 16 | Used the same as the work bits. However, if the power to the ZEN is turned OFF, these bits also maintain the previous ON/OFF status. | | | |
| Timers | T | T0 to Tf | 16 | X: ON-delay timer ■: OFF-delay timer O: One-shot pulse timer F: Flashing pulse timer W: Twin timer | Functions are selected from the screen when parameter settings are made. | Time units can be selected from the following: 0.01-s unit: 0.01 to 99.99 s min/s unit: 00 min 01 s to 99 min 59 s h/s unit: 00 h 01 min to 99 h 59 min | 2 |
| Holding timers | # | #0 to #7 | 8 | Hold the present value being counted even if the trigger input or power supply is turned OFF and continue timing when the trigger input or power is restored. | | 3 | |
| Counters | C | C0 to Cf | 16 | Reversible 4-digit counters that can be incremented and decremented. | | 4 | |
| 8-digit counter | F | F0 | 1 | Reversible 8-digit counters that can be incremented and decremented. CPU Units with DC power supply support a high-speed counter up to 150 Hz. For details, refer to <i>8-digit Counter Operation</i> on page 21. | | 5 | |
| Weekly timers (See note 3.) | @ | @0 to @f | 16 | Turn ON and OFF during specified times on specified days. | | 6 | |
| Calendar timers (See note 3.) | * | *0 to *f | 16 | Turn ON and OFF between specified dates. | | 7 | |
| Display bits (See note 3.) | D | D0 to Df | 16 | Display user-specified messages, times, timer/counter present values, or analog-converted values. | | 8 | |
| Analog comparator bits | A | A0 to A3 | 4 | Used as program input conditions to output analog comparator comparison results. These bits can be used only for CPU Units with DC power supply. | | 9 | |
| Timer/counter comparator bits | P | P0 to Pf | 16 | Compare the present values of timers (T), holding timers (#), and counters (C). Comparison can be made between the same two counters or timers, or with constants. | | 10 | |
| 8-digit counter comparator bits | G | G0 to G3 | 4 | Used to compare the present values of 8-digit counters (F) and output the comparison results. | | 11 | |
| Button input bits (See note 3.) | B | B0 to B7 | 8 | Used as program input conditions and turn ON when operation buttons are pressed in RUN Mode. | | 12 | |

Note: 1. For details, refer to the indicated item numbers on the following pages.

- CPU Units with 10 I/O points have 6 input bits (I0 to I5) and 4 output bits (Q0 to Q3). Output bit Q3 of Communications-type CPU Units, however, cannot be output externally. It can be used as a work bit.
- These input bits are not supported by LED-type CPU Units without display.

1. Additional Bit Output Functions

| [: Normal | Set/Reset operation | | A: Alternate |
|--|---|--|--|
| | S: Set | R: Reset | |
| | | | |
| Q0 will turn ON or OFF depending on the ON/OFF status of the execution condition I0. | Q1 will stay ON once the execution condition I1 has turned ON once. A reset is used to turn Q1 OFF. | Q1 is forced OFF when the execution condition I2 is turned ON. | Q2 alternates between turning ON and OFF when the execution condition I3 turns ON. |

2. Using Timers and Holding Timers

| | |
|---------------------------------------|--|
| <p>X: ON-delay timer</p> | <p>Turns ON after set delay after the trigger input turns ON. Basic Operation</p> <p>Main Applications When delayed operation or a time lag is required.</p> |
| <p>■: OFF-delay timer</p> | <p>Stays ON while the trigger input is ON and turns OFF after a set delay after the trigger input has turned OFF. Basic Operation</p> <p>Main Applications Useful for OFF delay circuits for lights or fans</p> |
| <p>O: One-shot pulse timer</p> | <p>Turns ON for a set period after the trigger input turns ON and regardless of how long the trigger input remains ON. Basic Operation</p> <p>Main Applications Useful for set operations where operation is always required during a regular period only.</p> |
| <p>F: Flashing pulse timer</p> | <p>Repeatedly turns ON and OFF in a set cycle while the trigger input is ON. Basic Operation</p> <p>Main Applications Useful for flashing emergency lights or sounding buzzers as the output for an alarm circuit.</p> |
| <p>W: Twin timer</p> | <p>Repeatedly turns ON and OFF in a set cycle while the trigger input is ON. Independent ON- and OFF-time settings are possible. Basic Operation</p> <p>Main Applications Useful for intermittent (ON/OFF) operation, such as that used for fans.</p> |

3. Using Holding Timers

| | |
|---------------------------------|--|
| <p>X: ON-delay timer</p> | <p>Turns ON after set delay after the trigger input turns ON. The present value is held while the trigger input is OFF. Main Applications To continue operation after momentary power loss or power interruptions. Also can be used when delayed operation or a time lag is required.</p> |
|---------------------------------|--|

4. Counter Operation

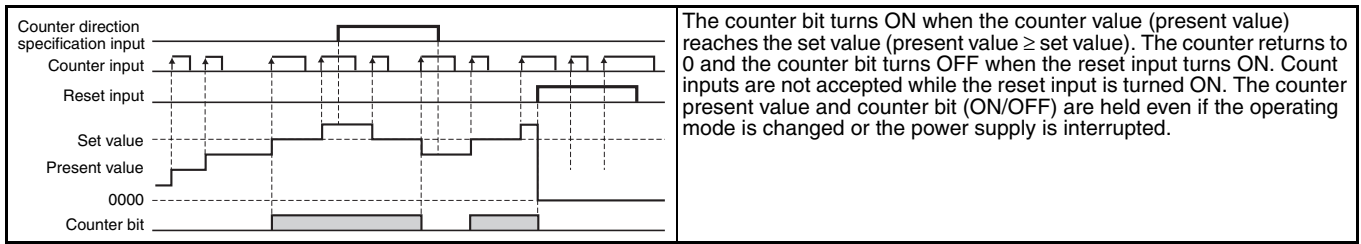

5. 8-digit Counter Operation

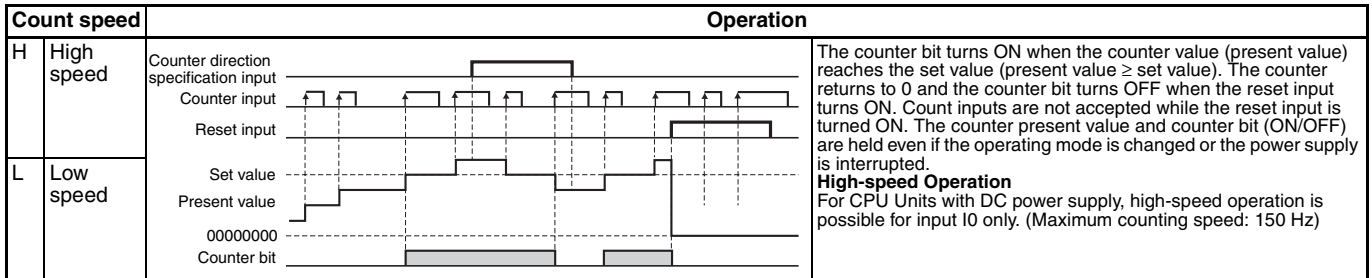

Counting Speed of the 8-digit Counter

The maximum counting speed of the 8-digit counter is 150 Hz. When the ladder program volume is large, however, this speed will be less than 150 Hz. Calculate the cycle time and confirm the maximum counting speed using the following formula. The calculation serves as a guide only, so allow a suitable margin in the actual machine.

$$\text{Maximum counting speed} = 1,000,000 \text{ Hz} / (\text{Cycle time } (\mu\text{s}) \times 2.2) \text{ Hz}$$

Note: Even if the calculated maximum counting speed exceeds 150 Hz using this formula, the maximum counting speed will be 150 Hz.

Cycle Time Calculation Method

$$\text{Cycle time } (\mu\text{s}) = \text{Common processing time} + \text{Processing time taken when Expansion I/O Units are connected} + \text{Ladder program execution time} + \text{Communications processing time (only for CPU Units with communications)}$$

Refer to the following table for ZEN execution times. The execution times are provided as a guide. External factors, button operations, execution of ZEN Support Software operations, and timing of the processing affects the actual processing times.

Common Processing Time

| Unit type | Common processing time |
|--|------------------------|
| Standard LCD-type CPU Units, Economy-type CPU Units, and Communications-type CPU Units | 850 μs |
| LED-type CPU Units | 200 μs |

Expansion I/O Unit Processing Time

| Unit type | Expansion I/O Unit processing time |
|---------------------|------------------------------------|
| Expansion I/O Units | 160 μs per Unit |

Communications Processing Time (only for CPU Units with Communications)

| | |
|--------------------------|---|
| Reading information | 170 μs |
| Writing set values | Twin timer: 11,000 μs Others: 6,000 μs |
| Writing time information | 820 μs |

Ladder Program Execution Time

| | | | |
|------------|---|--|----|
| Per line | 30 μs: Line containing program 7 μs: Empty lines | *1 | |
| Per output | CPU Unit output bits (Q) | 4 μs | *2 |
| | Expansion I/O Unit output bits (Y) | | |
| | Work bits (M) | | |
| | Holding bits (H) | | |
| | Timers (T)/Holding timers (#) | 15 μs | *3 |
| | Counters (C)/8-Digit Counters (F) | 13 μs | |
| | Display bits (D) | Hour and minute (CLK)/Year and month (DAT)/Month and day (DAT1): 21 μs Timers (T)/Holding timers (#)/Counters (C)/Analog comparators: 28 μs Characters (CHR)/8-Digit Counters (F): 38 μs | |
| | Weekly timers (@) | 4 μs | *4 |
| | Calendar timers (*) | 1 μs | |
| | Analog comparators (A) | 3 μs | |
| | Comparators (P) | 7 μs | *5 |
| | 8-Digit Comparators (G) | 4 μs | |

Example Calculation of Ladder Program Execution Time

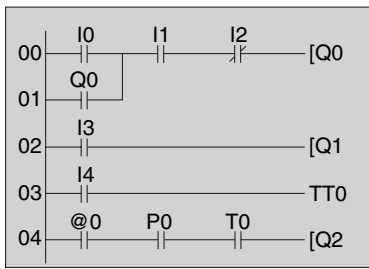

Ladder program execution time = $(30 \times 5) + (4 \times 3) + 15 + 4 + 7 = 188 \text{ (}\mu\text{s)}$

- *1: For 5 lines
- *2: Q (outputs) for 3 points
- *3: T0 (output)
- *4: @0
- *5: P0

6. Weekly Timer Operation (Only for Standard LCD-type, Economy-type, and Communications-type CPU Units)

| Weekly timer mode | Operation | |
|-----------------------------|--|--|
| N Normal operation | Typical Timer Operation | Between Tuesday and Friday every week, the weekly timer bit turns ON from 08:15 until 17:30. |
| | Timer Operation Extending Past Midnight | Between Tuesday and Friday every week, the weekly timer bit turns ON from 23:00 until 05:00 the following day. |
| D Multiple-day operation | | The weekly timer bit turns ON from Tuesday 08:15 until Friday 17:30 every week. |
| P Pulse-output operation | | Every week, from Tuesday through Friday, the weekly timer bit turns ON for 15 minutes and thirty seconds from 08:15. |

7. Calendar Timer Operation (Only for Standard LCD-type, Economy-type, and Communications-type CPU Units)

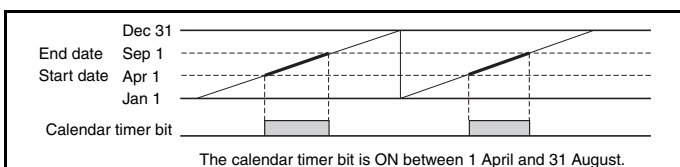

8. Display Settings (Only for Standard LCD-type, Economy-type, and Communications-type CPU Units)

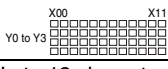
| | | |
|--|--|---|
| Backlight/display function screen switching | L0: No backlight; No switching to display function screen (See note 1.) L1: Backlight; No switching to display function screen (See note 1.) L2: No backlight; Switching to display function screen (See note 2.) L3: Backlight; Switching to display function screen (See note 2.) | |
| Display start position | X (digit): 00 to 11 Y (line): 0 to 3  | |
| Display object | CHR | Characters (Up to 12 characters - English, numerals, symbols) |
| | DAT | Month/day (5 digits □□/□□) |
| | CLK | hour/minute (5 digits □□:□□) |
| | I4 to I5 | Analog-converted value (4 digits □□:□) |
| | T0 to Tf | Timer present value (5 digits □□.□□) |
| | #0 to #7 | Holding timer present value (5 digits □□.□□) |
| | C0 to Cf | Counter present value (4 digits □□□□) |
| | F0 | 8-digit counter present value (8 digits □□□□□□□□) |
| Monitoring | A: Can read settings during operation. D: Cannot read settings during operation. | |

- Note:** 1. When L0 or L1 are selected to disable the display function screen, the display function screen will not be displayed automatically. Use operation buttons to move to the display function screen.
2. When L2 or L3 are selected, the ZEN switches to the display function screen if the display function is enabled and the specified data is displayed. The Main Screen will no longer be displayed. To display the Main Screen, change the CPU Unit to STOP mode.

9. Analog Comparator Operation

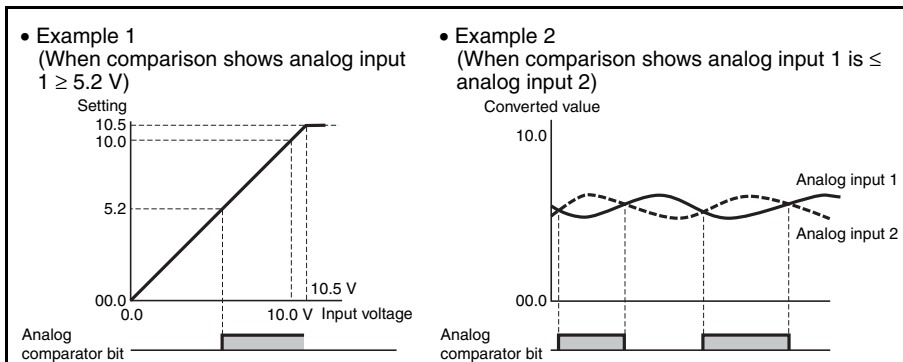

10. Timer/Counter Comparator Operation

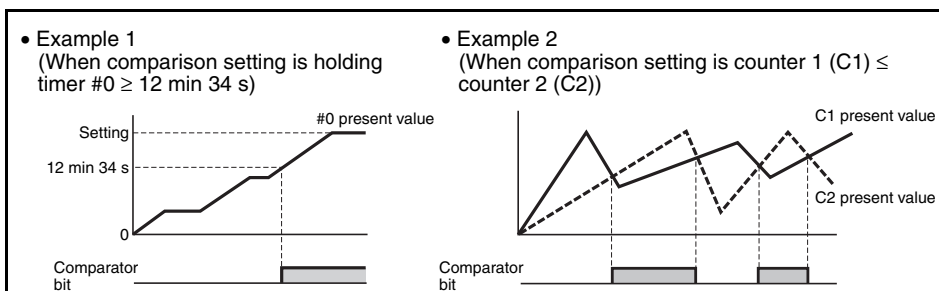

11. 8-digit Counter Comparator Operation

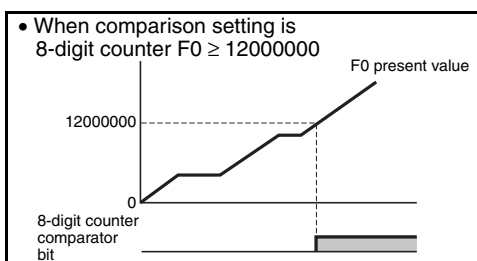

12. Specifications for Button Input Bits (Only for Standard LCD-type, Economy-type, and Communications-type CPU Units)

The operation buttons are used to perform operations for input bits. They are useful when checking program operations or forcefully resetting holding timers or counters.

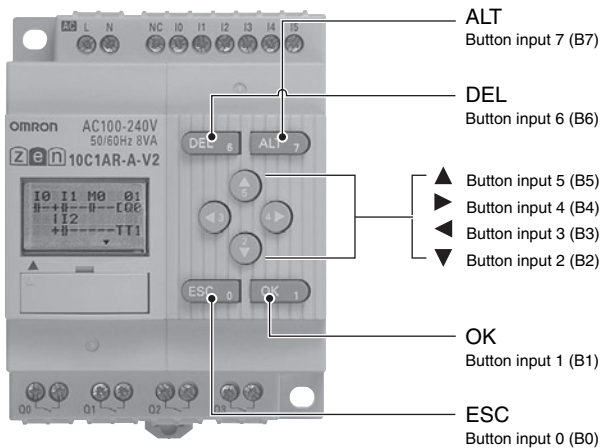

■ Password Function (Only for Standard LCD-type, Economy-type, and Communications-type CPU Units)

The ZEN has a password function to prevent incorrect manipulation of ladder programs or settings data by other operators. When the password (0000 to 9999) is set, the following operations will not be possible unless the password is input correctly.

- Editing ladder program
- Program all clear
- Monitoring ladder programs
- Changing/clearing password
- Changing backlight OFF time
- Setting input filter
- Setting RS-485 communications

■ ZEN Support Software Functions

Note: Always use ZEN-SOFT01-V4 as the Support Software for the V2 CPU Unit.

Creating Ladder Programs

ZEN ladder programs can be created with ease.

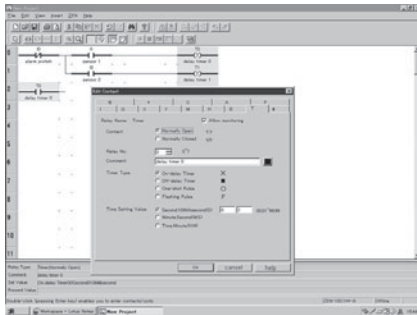

Note: The Edit Input Dialog Box is displayed when an input bit is inserted. Timer, counter, and other parameter settings are also set in the Edit Input Dialog Box. They cannot be set in the Edit Output Dialog Box.

Monitoring Ladder Programs

The operating status can be monitored from the Support Software by connecting to the ZEN using a Connecting Cable (ZEN-CIF01).

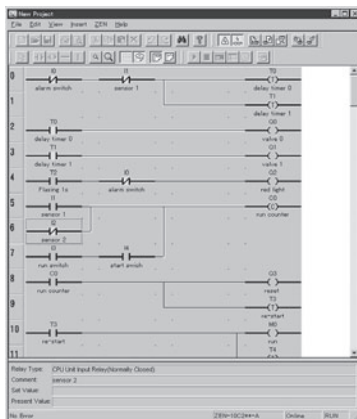

Note: Both RS-485 communications and the ZEN monitoring function cannot be used at the same time with Communications-type CPU Units.

The Support Software can also be used to save files and edit comments.

Refer to the *ZEN Support Software Operation Manual* (Cat. No. Z184-E1-03) for details.

Simulating Ladder Programs

The simulation function makes it possible to check whether correct operation is performed without connecting to the ZEN.

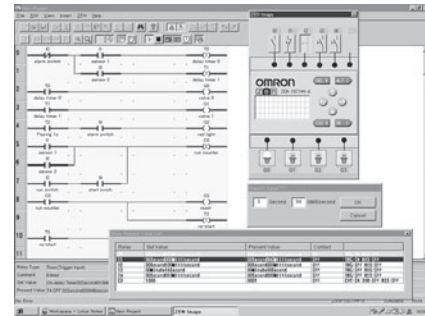

Printing Ladder Programs

Ladder programs and I/O comments, as well as timer, counter and other parameter settings can be printed.

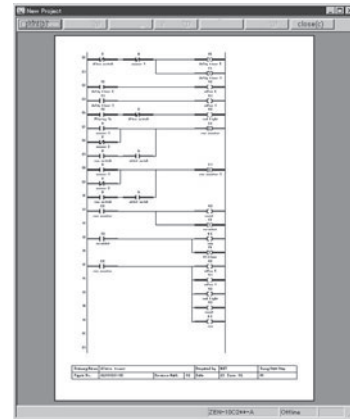

Dimensions

Note: All units are in millimeters unless otherwise indicated.

CPU Units

CPU Units with 10 I/O Points ZEN-10C□□□□-V2

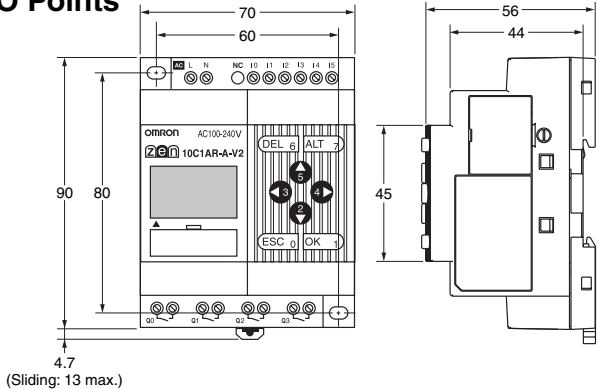
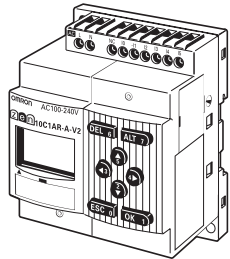

Unit Mounting Holes

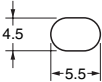

Note: Use M4 screws for mounting.

Mounting Hole Dimensions

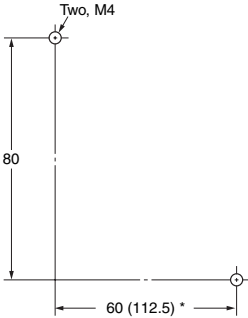

* The dimensions in parentheses refer to models with 20 I/O points.

CPU Units with 20 I/O Points ZEN-20C□□□□-V2

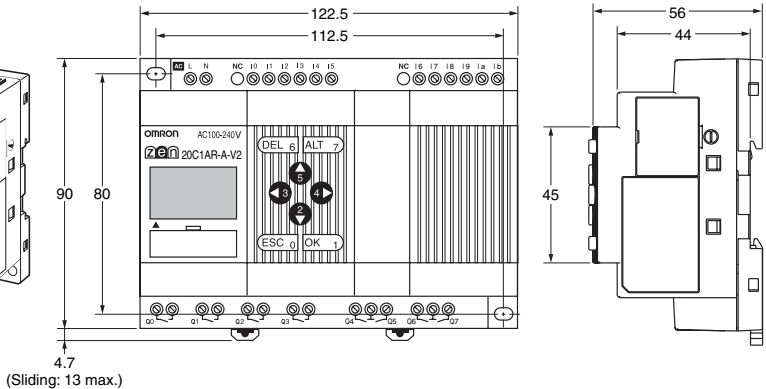
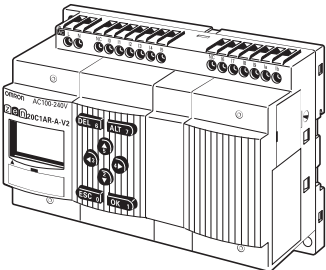

Dimensions with Battery Unit

CPU Units with 10 I/O Points

CPU Units with 20 I/O Points

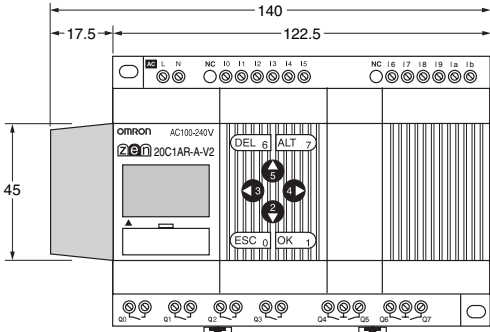
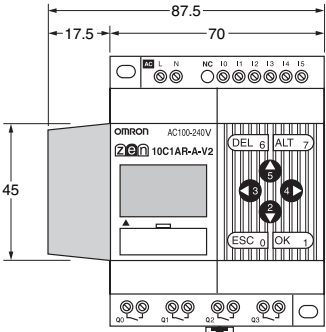
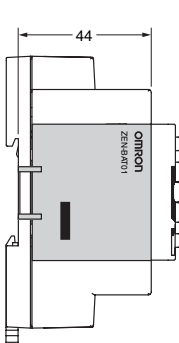

Expansion I/O Units

ZEN-8E1 □□

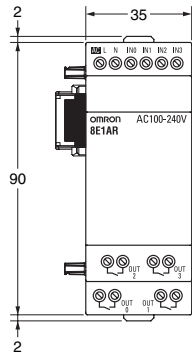
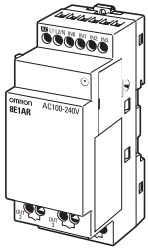

DIN Track Hook
(Using Slide)

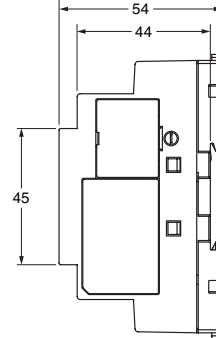
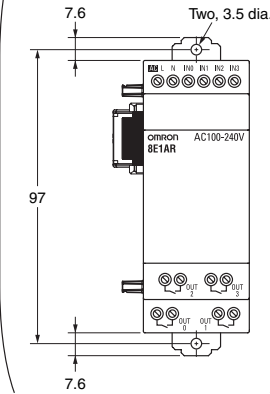

Mounting Hole Dimensions

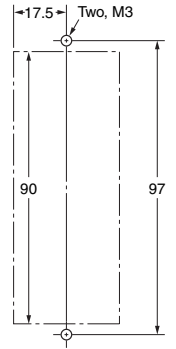

Power Supply Unit

ZEN-PA03024

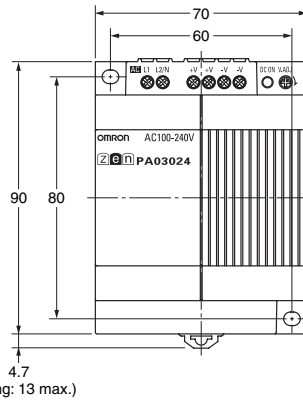
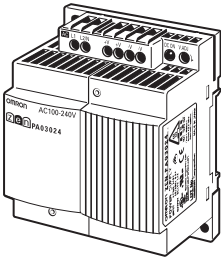

4.7
(Sliding: 13 max.)

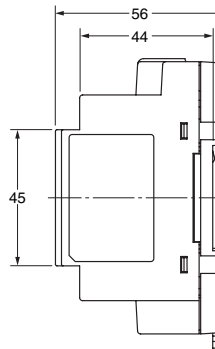

Mounting Hole Dimensions

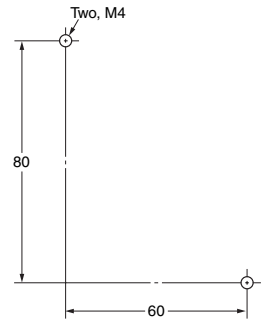

Accessories (Order Separately)

Battery Unit

ZEN-BAT01

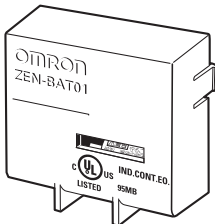

Memory Cassette

ZEN-ME01

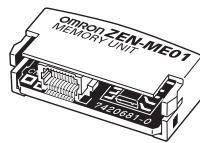

Connecting Cable

ZEN-CIF01

Cable length: 2m

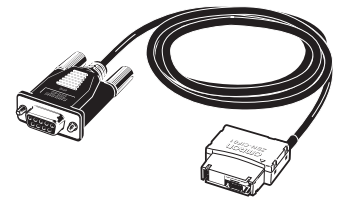

■ Track Mounting Accessories (Order Separately)

Mounting Track

**PFP-100N
PFP-50N**

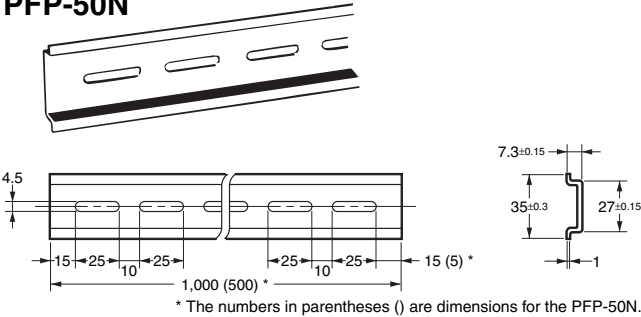

PFP-100N2

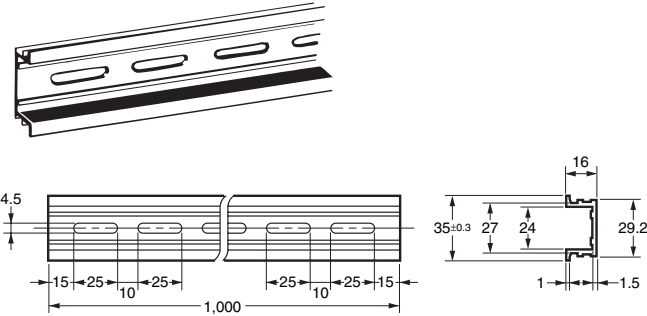

End Plate

PFP-M

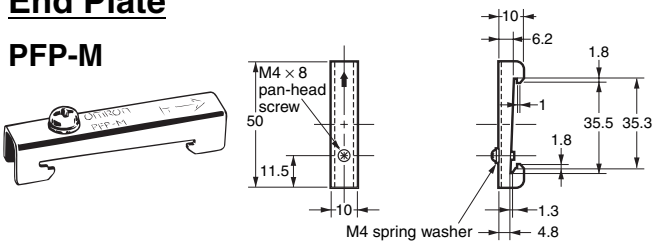

Spacer

PFP-S

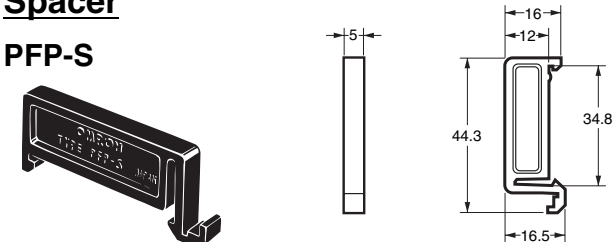

Precautions when Selecting ZEN Programmable Relays

■ Changes in Comparison with Previous Models

- The power supply and transistor output voltage ranges for CPU Units and Expansion I/O Units with DC power supply has been expanded to 10.8 to 28.8 VDC.
- The width of Expansion I/O Units has been reduced by half and only 8-point models are available.
- The connection method between the CPU Unit and Expansion I/O Units has changed.
- Twin timer operation has been added to timers.
- Multiple-day operation and pulse-output operation has been added to weekly timers.
- An 8-digit counter and 8-digit comparators have been added.
- The accuracy of analog inputs has been increased to ±1.5% FS.
- The timing accuracy of weekly timers and calendar timers has been increased to ±15 s or less per month (at 25°C).
- Australia and New Zealand Daylight Saving Time (DST) settings have been added.
- CPU Units with RS-485 communications and economic CPU Units have been added.
- The heat slits in the cases of CPU Units and Expansion I/O Units have been removed to prevent foreign matter from entering.

Model numbers have been changed to reflect the improved functionality.

Previous Model Numbers

| | |
|----------------|----------------------------------|
| ZEN-C□□□□-□ | (Pre-V1 CPU Units) |
| ZEN-C□□□□-□-V1 | (V1 CPU Units) |
| ZEN-E□□□ | (4E/8E-type Expansion I/O Units) |



New Model Numbers

| | |
|----------------|-------------------------------|
| ZEN-C□□□□-□-V2 | (V2 CPU Units) |
| ZEN-8E1□□□ | (8E1-type Expansion I/O Unit) |

Memory Cassettes, Connecting Cables, and Battery Units have not been changed and can be used as they are with the new models.

Precautions when Switching from Previous Units

- Previous models of Expansion I/O Units cannot be connected to V2 CPU Units.
- ZEN-8E1□R Expansion I/O Units with relay outputs need to be connected to a power supply.
- A ZEN-□□□□-D-V2 CPU Unit with DC power supply cannot be connected to an Expansion I/O Unit with AC inputs.
- When connecting Expansion I/O Units with DC inputs to a CPU Unit with an AC power supply, the burst noise immunity will be 1 kV (IEC 61000-4-4).
- There is no change to the 8 A per contact for relay output, but the total output for all contacts must be as follows:
Units with 10 I/O Points: 20 A max. (15 A max. for Communications-type CPU Units)
Units with 20 I/O Points: 40 A max.
Expansion I/O Units: 20 A max.
- Always use the ZEN-SOFT01-V4 Support Software for V2 CPU Units.
- Input wiring for CPU Units with DC power supplies differs from that for Pre-V1 CPU Units. Refer to the following diagrams.

V2 and V1 CPU Units

COM wiring depends on whether a negative common or positive common is being used.

Negative (-) COM Wiring

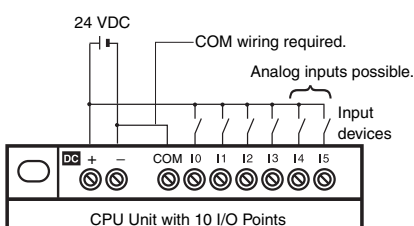

Positive (+) COM Wiring

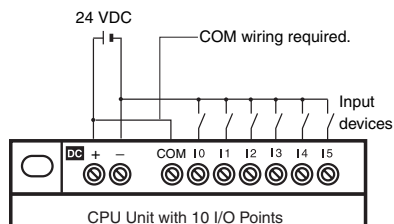

Note: I4 and I5 (Ia and Ib for CPU Units with 20 I/O points) cannot be used as analog input terminals.

Pre-V1 CPU Units

The input circuit common terminal is connected internally to the negative (-) side of the power supply circuit.

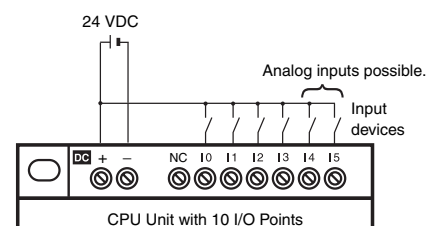

Changes

Ratings and Specifications

CPU Units

| Item | | V2 Units | V1 Units | Pre-V1 Units |
|---|-----------------------------|--|---|--|
| Rated power supply voltage | Models with DC power supply | 10.8 to 28.8 VDC | 20.4 to 26.4 VDC | |
| Power consumption | Models with AC power supply | See <i>Ratings</i> on page 7. | | 30 VA max. (with 3 Expansion I/O Units connected) |
| | Models with DC power supply | | | 6.5 W max. (with 3 Expansion I/O Units connected) |
| Inrush current | Models with AC power supply | Models with 10 I/O points: 4.5 A max. Models with 20 I/O points: 4.5 A max. | 40 A max. | |
| | Models with DC power supply | Models with 10 I/O points: 30 A max. Models with 20 I/O points: 30 A max. | 20 A max. | |
| DC inputs I0 to I3 (See note 1.) | Input impedance | 5.3 kΩ | 5 kΩ | 4.8 kΩ |
| | ON voltage | 8 VDC min. | 16 VDC min. | |
| | Input common | Independent common terminal | | |
| DC inputs I4 to I5 (See note 2.) | Input impedance | 5.2 to 5.5 kΩ | 5 kΩ | |
| | ON voltage | 8 VDC min. | 16 VDC min. | |
| | OFF voltage | 3 VDC max. | 5 VDC max. | |
| Analog inputs I4 to I5 (See note 2.) | Input impedance | 100 kΩ min. | 150 kΩ min. | |
| | Accuracy | ±1.5% FS (at ambient operating temperature within rated range) | ±10% FS (at ambient operating temperature within rated range) | |
| Control outputs | Relay outputs | 8 A per output Total for all outputs must be as follows: Units with 10 I/O Points: 20 A max. (15 A max. for Communications-type CPU Units) Units with 20 I/O Points: 40 A max. | 8 A per output | |
| | Transistor outputs | 28.8 V max. | 26.4 V max. | |
| Timing accuracy of weekly and calendar timers | | ±15 s or less per month (at 25°C) | ±2 min per month | |
| Mounting direction | | Standard (vertical) installation and horizontal installation | Standard (vertical) installation | |
| Terminal block tightening torque | | 0.565 to 0.6 N·m (5 to 5.3 in·lb) | 0.5 to 0.6 N·m | |
| Connectable Expansion I/O Units | | ZEN-8E1□ (See note 3.) | ZEN-4E□ and ZEN-8E□ | |
| Case structure | | No heat slits | Heat slits | |

Note: 1. Units with 20 I/O Points: I0 to I9

2. Units with 20 I/O Points: Ia to Ib

3. Refer to page 31 for details on compatible combinations of CPU Units and Expansion I/O Units.

Expansion I/O Units

| Item | | 8E1 type | 4E/8E type |
|-------------------------------|---------------------------|---|---|
| Model | | Unit with 8 I/O Points | Units with 4 input, 4 output, or 8 I/O points |
| AC inputs | Input impedance | 680 kΩ | 83 kΩ |
| | Isolation | No isolation | Photocoupler |
| | Input common | Internally connected to power supply terminal | Independent common terminal |
| DC inputs | Input voltage | 10.8 to 28.8 VDC | 20.4 to 26.4 VDC |
| | Input impedance | 6.5 kΩ | 4.7 kΩ |
| | Isolation | ZEN-8E1DR: No isolation ZEN-8E1DT: Photocoupler | Photocoupler |
| | ON voltage | 8 VDC min. | 16 VDC min. |
| | Input common | ZEN-8E1DR: Internally connected to power supply terminal ZEN-8E1DT: Independent common terminal | Independent common terminal |
| Control output | Relay outputs | 8 A per output Total for all outputs must be as follows: Units with 10 I/O Points: 20 A max. Units with 20 I/O Points: 40 A max. | 8 A per output |
| | Transistor outputs | 28.8 V max. | 26.4 V max. |
| Mounting screws | | M3 (mounting holes on DIN Track hooks) | M4 (mounting holes on Unit) |
| Connectable CPU Unit | | V2 CPU Units (See note.) | V1 or Pre-V1 CPU Units |
| Dimensions (H × W × D) | | 90 × 35 × 56 mm | 90 × 70 × 56 mm |
| Case structure | | No heat slits | Heat slits |

Note: Refer to page 31 for details on compatible combinations of CPU Units and Expansion I/O Units.

Other Functions

| Item | | V2 Units | V1 Units | Pre-V1 Units |
|---|------------------------------------|---|---|---|
| Bits | Timer operation | ON-delay, OFF-delay, one-shot pulse, flushing pulse, twin timer operation | ON-delay, OFF-delay, one-shot pulse, flushing pulse | |
| | Weekly timer operation | Timer operation, multiple-day operation, pulse-output operation | Timer operation | |
| | Addition of bits | 8-digit counter (1 counter, up to 150 Hz) 8-digit comparators (4 comparators) | --- | |
| Daylight Saving Time (DST) Setting | | Manual, EU, US. Australia, New Zealand | Manual, EU, US | |
| Items set for password | | Ladder program editing Program all clear Ladder monitoring Password change/clear Backlight shut-off time Input filter settings Node number setting (See note.) | | Ladder program editing Ladder monitoring Password change/clear Backlight shut-off time Input filter settings Node number setting |
| LCD contrast adjustment | | Not possible | Possible | |
| Menus | Node number setting window | Node number setting window deleted (except for Units with communications). | Node number setting window displayed. | |
| | Modem initialization window | Modem initialization window deleted (except for Units with communications). | Modem initialization window displayed. | |
| RS-485 communications | | Models added with communications. ZEN-10C4□R-□-V2 | --- | |
| Economy-type CPU Units | | Economy-type models added. ZEN-□C3□R-□-V2 Expansion I/O Units cannot be connected. Other functions are the same as the standard LCD models. | --- | |

Note: Not displayed for V2 CPU Units except for Units with Communications.

Bits

| Name | | CPU Unit | | | | |
|---------------------------------|---|----------------------|---------------|---------------|---------------|---------------|
| | | V2 Units | | V1 Units | | Pre-V1 Units |
| | | 10 I/O points | 20 I/O points | 10 I/O points | 20 I/O points | 10 I/O points |
| Input bits | I | 6 points | 12 points | 6 points | 12 points | 6 points |
| Output bits | Q | 4 points (See note.) | 8 points | 4 points | 8 points | 4 points |
| Timers | T | 16 points | | | | 8 points |
| Holding timers | # | 8 points | | | | 4 points |
| Counters | C | 16 points | | | | 8 points |
| Weekly timers | @ | 16 points | | | | 8 points |
| Calendar timers | * | 16 points | | | | 8 points |
| Display bits | D | 16 points | | | | 8 points |
| Work bits | M | 16 points | | | | |
| Holding bits | H | 16 points | | | | |
| Expansion input bits | X | 12 points | | | | |
| Expansion output bits | Y | 12 points | | | | |
| Analog comparator bits | A | 4 points | | | | |
| Timer/counter comparator bits | P | 16 points | | | | |
| 8-digit counter | F | 1 point | | --- | | |
| 8-digit counter comparator bits | G | 4 points | | --- | | |

Note: Output bit Q3 of Communications-type CPU Units cannot be output externally. It can be used as a work bit.

Compatible Combinations of CPU Units and Expansion I/O Units

The Expansion I/O Units that can be connected to V2 CPU Units are different from those that can be connected to V1 CPU Units and previous CPU Units. Expansion I/O Units with AC Inputs cannot be connected to V2 CPU Units with DC Power Supplies. Expansion I/O Units cannot be connected to Economy-type CPU Units.

| CPU Units | | | | Supported Expansion I/O Units |
|---------------|--|----------------|--|---|
| Version | CPU Unit type | Power supply | Model | |
| V2 | Standard LCD type LED type Communications type | AC | ZEN-□C1AR-A-V2 ZEN-□C2AR-A-V2 ZEN-10C4AR-A-V2 | ZEN-8E1AR ZEN-8E1DR ZEN-8E1DT |
| | | DC | ZEN-□C1D□-D-V2 ZEN-□C2D□-D-V2 | ZEN-8E1DR ZEN-8E1DT |
| | | AC | ZEN-□C3AR-A-V2 | Not supported. |
| | DC | ZEN-□C3DR-D-V2 | | |
| V1 and Pre-V1 | Standard LCD type LED type | AC | ZEN-□C1AR-A-V1 ZEN-□C1AR-A ZEN-□C2AR-A-V1 ZEN-□C2AR-A | ZEN-4EA ZEN-4ED ZEN-4ER ZEN-8EAR ZEN-8EDR ZEN-8EDT |
| | | DC | ZEN-□C1D□-D-V1 ZEN-□C1D□-D ZEN-□C2D□-D-V1 ZEN-□C2D□-D | |

Memory Cassette and CPU Unit Combinations

Be aware of the following restrictions when using a Memory Cassette containing a program that was stored from a CPU Unit with a different version of system software.

| System software version of CPU Unit used to write the Memory Cassette | System software version of CPU Unit used to read the Memory Cassette | | | | | | |
|---|--|---------------------------------------|---------------------------------------|----------------------------|----------------------------|----------------------------|---------------|
| | | Ver. 1.0 | Ver. 1.1 | Ver. 2.0 (V1 CPU Units) | | Ver. 3.0 (V2 CPU Units) | |
| | | | | 10 I/O points | 20 I/O points | 10 I/O points | 20 I/O points |
| Ver. 1.0 | | OK | OK | OK | OK | OK | OK |
| Ver. 1.1 | | Restrictions (See note 1.) | OK | OK | OK | OK | OK |
| Ver. 2.0 (V1 CPU Units) | 10 I/O points | Restrictions (See notes 1 and 2.) | Restrictions (See note 2.) | OK | OK | OK | OK |
| | 20 I/O points | Restrictions (See notes 1, 2, and 3.) | Restrictions (See notes 2 and 3.) | Restrictions (See note 3.) | OK | Restrictions (See note 3.) | OK |
| Ver. 3.0 (V2 CPU Units) | 10 I/O points | Restrictions (See notes 1, 2, and 4.) | Restrictions (See notes 2 and 4.) | Restrictions (See note 4.) | Restrictions (See note 4.) | OK | OK |
| | 20 I/O points | Restrictions (See notes 1 to 4.) | Restrictions (See notes 2, 3, and 4.) | Restrictions (See note 4.) | Restrictions (See note 4.) | Restrictions (See note 3.) | OK |

- Note:**
- The display functions (display clear: -CD□ and day/month display: DAT1) cannot be used and will be ignored.
 - Only the memory area ranges supported by the pre-V1 CPU Units can be used for Timers, Holding Timers, Counters, Weekly Timers, Calendar Timers, and Displays (i.e., only half of each).
 - Only 6 inputs and 4 outputs can be used in the CPU Unit I/O bits. Any others will be ignored.
 - Twin timer operation for timers, multiple-day operation and pulse operation for weekly timers, the 8-digit counter, and 8-digit comparators cannot be used. New Zealand and Australia cannot be set for Daylight Saving Time (DST).

Support Software and CPU Unit Combinations

| CPU Unit system software | | Support Software | | | |
|--------------------------|---------------|--------------------------------------|-------------------------------|--------------------------------------|--|
| | | Ver. 1.0 ZEN-SOFT01 | Ver. 2.0 ZEN-SOFT01-V2 | Ver. 3.0 ZEN-SOFT01-V3 | Ver. 4.1 ZEN-SOFT01-V4 |
| Ver. 1.0 (Pre-V1 Units) | | OK | OK | Restrictions (See notes 1 and 2.) | Restrictions (See notes 1, 2, and 3.) |
| Ver. 1.1 (Pre-V1 Units) | | Restrictions (See note 1.) | OK | Restrictions (See note 2.) | Restrictions (See notes 2 and 3.) |
| Ver. 2.0 (V1 CPU Units) | 10 I/O points | Restrictions (See notes 1 and 2.) | Restrictions (See note 2.) | OK | Restrictions (See note 3.) |
| | 20 I/O points | Not applicable. | Not applicable. | OK | Restrictions (See note 3.) |
| Ver. 3.0 (V2 CPU Units) | | Not applicable. | Not applicable. | Not applicable. | OK |

- Note:**
- The display functions (display clear: -CD□ and day/month display: DAT1) cannot be used and will be ignored.
 - Only the memory area ranges supported by the pre-V1 CPU Units can be used for Timers, Holding Timers, Counters, Weekly Timers, Calendar Timers, and Displays (i.e., only half of each).
 - Twin timer operation for timers, multiple-day operation and pulse operation for weekly timers, the 8-digit counter, and 8-digit comparators cannot be used. New Zealand and Australia cannot be set for Daylight Saving Time (DST).

Difference between ZEN Programmable Relays and PLC Ladder Program Execution

ZEN Programmable Relays

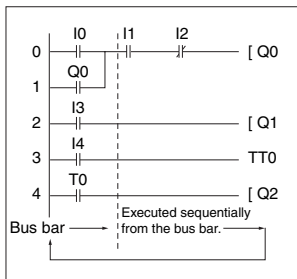

ZEN executes the entire ladder program (up to 96 lines) from the first to last line at one time. Each row is executed in order from left to right starting from the left bus bar.

The ON/OFF status produced by an output contact will not be used as the input contact status in the same cycle, but it can be used in the next cycle.

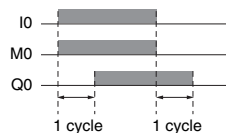
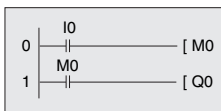

OMRON SYSMAC PLCs

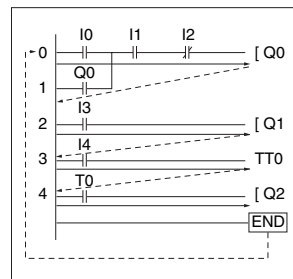

PLCs execute ladder programs one rung (circuit) at a time, starting with the top rung and executing it in order from the left. When the END instruction is reached, the program is executed again from the first rung.

When the following instructions are executed, Q0 turns ON/OFF at the same time as the other bits.

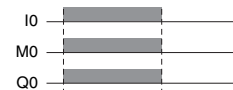
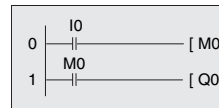

Safety Precautions

Refer to *Safety Precautions for All Timers*.

⚠ WARNING

Serious human hazard may occasionally occur due to ignition or rupture of the lithium battery used in the Battery Unit. Do not short the battery terminals or charge, disassemble, deform under pressure, or incinerate the battery.

Never use any battery that has been dropped on the floor or otherwise subjected to excessive shock.

⚠ CAUTION

Electric shock, fire, or malfunction may occur. Do not disassemble, modify, or repair the ZEN or touch any of the internal parts.

Electric shock may occur. Never touch the I/O terminals, computer connector, or Battery Unit connector while power is being supplied.

Electric shock may occur. Do not remove the Expansion Unit connector cover unless an Expansion I/O Unit will be permanently installed.

Fire may occasionally occur. Tighten the terminal screws to a torque of 0.565 to 0.6 N·m (5 to 5.3 in-lb).

■ Precautions for Safe Use

Please observe the following precautions for safe use of this product.

Circuit Design

- All interface connectors and battery connectors are live parts. They may not be directly connected to a Safety Extra Low Voltage (SELV) circuit or to accessible conductive parts. For programming units and personal computers use only the connecting cable ZEN-CIF01 (optional accessory) manufactured by OMRON. ZEN-CIF01 provides safe (reinforced) insulation between personal computers and ZEN.
- Provide emergency stop circuits, external interlock circuits, limit circuits, and other safety circuits in addition to any provided within the ZEN control circuits to ensure safety of the overall system in the event of ZEN failure or external factors.
- If the ZEN discovers an error during self-diagnosis, operation will be stopped and all outputs will be turned OFF. As a countermeasure for such problems, external safety measures must be provided to ensure safety in the overall system.
- Outputs from the ZEN may remain ON or OFF due to faults in internal circuits such as output relay fusing or burning, or output transistor destruction. As a countermeasure for such problems, external safety measures must be provided to ensure safety in the overall system.
- Fail-safe measures must be taken by the user to ensure overall system safety in the event of broken signal lines or momentary power interruptions.
- The durability of the output relays is largely affected by the switching conditions. Confirm the operation of the system under actual operating conditions and set the switching frequency to ensure that adequate performance will be provided. Insulation faults and burning in the ZEN may result if relays are used after their performance has deteriorated.

Connecting Expansion I/O Units

- Supply power to both the CPU Unit and Expansion I/O Units from the same power supply and turn them ON and OFF at the same time.
- When connecting Expansion I/O Units with DC inputs to a CPU Unit with an AC power supply, the burst noise immunity will be 1 kV (IEC 61000-4-4).
- Expansion I/O Units with AC inputs (ZEN-8E1AR) cannot be connected to a CPU Unit with a DC power supply.

System Startup and Program Changes

- Check the user program for proper execution before actually running it on the Unit.

- Disconnect the output lines from the system before testing operation in any system in which incorrect operation can result in injury or equipment damage.
- Confirm safety before attempting any of the following operations.
 - Changing the operating mode (RUN/STOP).
 - Using the button switches.
 - Changing bit status or parameter settings.
- Double-check all wiring before turning ON the power supply.
- Refer to *Cycle Time Calculation Method* on page 21 and confirm that the increase in the cycle time will not affect operation. If the cycle time is too long, it may become impossible to read input signals accurately. The increase in the cycle time will be particularly noticeable when set values are written in RUN mode for a CPU Unit with communications (ZEN-10C4□R□V2).

Installation and Wiring

- Do not allow the ZEN to fall during installation.
- Be sure that the DIN Track mounting levers, Memory Cassettes, Battery Units, cable connectors, and other items with locking devices are properly locked into place. Improper locking may result in malfunction.
- For surface mounting, tighten mounting screws to the following torque.
 - CPU Units: 1.03 N·m max.
 - Expansion I/O Units: 0.46 N·m max.
- Use wires with cross-sectional areas of 0.2 to 2.5 mm² (equivalent to AWG24 to AWG14) for wiring and strip them for 6.5 mm.

Handling

- The environment of use for the ZEN is "Pollution degree 2" and "Overvoltage category II" specified in IEC60664-1.
- Always use the ZEN within the rated ambient operating temperature and humidity. The rated ambient operating temperature is 0 to 55°C (–25 to 55°C for LED-type CPU Units). If the ZEN is used near sources of heat, such as a power supply, the internal temperature of the ZEN may increase, lowering the durability of the ZEN.
- Discharge static electricity from your body, e.g., by touching a grounded metal plate, before touching any Unit.
- The exterior of the Units will be damaged if it comes into contact with organic solvents (e.g., benzene or paint thinner), strong alkalis, or strong acids. Never allow such substances to come into contact with the Units.
- Do not apply voltages exceeding the rated voltages. Internal elements may be destroyed.
- Short failures or open failures may result from the destruction of output elements. Do not use loads that exceed the rated output current.

Maintenance

When replacing a CPU Unit, transfer to the new Unit and confirm all settings for clock data, internal holding bits, holding timers, and counters before starting operation again.

Transportation and Storage

- Use special packing boxes when transporting the ZEN and do not subject it to excessive shock or vibration or drop it during shipment.
- Store the ZEN within the rated ranges. If the ZEN has been stored at –10°C or lower, allow it to stand at room temperature for three hours or longer before turning ON the power supply.

■ Precautions for Correct Use

Installation Environment

- Do not install the ZEN in the following locations.
 - Locations subject to radical changes in temperature

- Locations with high humidity subject to condensation
- Locations subject to excessive dust or dirt
- Locations subject to corrosive gas
- Locations subject to direct sunlight
- Do not install the ZEN in locations subject to shock or vibration. Extended use in such locations may cause damage from stress.
- In environments subject to static electricity (e.g., close to pipes conveying forming materials, powders, or fluid materials), separate the ZEN as far as possible from the source of static electricity.
- The ZEN is neither waterproof nor oil-proof. Do not use it in locations subject to water or oil.
- Use the ZEN within the allowable power supply voltage range. Be particularly careful in locations with bad power supply conditions, e.g., large fluctuations in the power supply voltage.
- Do not install the ZEN in locations subject to excessive noise, which may cause the ZEN to fail.
- Take appropriate and sufficient countermeasures when installing systems in the following locations:
 - Locations subject to strong electromagnetic fields
 - Locations subject to possible exposure to radioactivity

Power Supply

- Always turn OFF the power supply to the ZEN before attempting any of the following.
 - Assembling the ZEN
 - Connecting or disconnecting any cables or wiring
 - Attaching or removing the Memory Cassette
 - Attaching or removing the Battery Unit
- If the power supply is interrupted for two days or more (at 25°C), the internal capacitor will discharge and internal bit status and the contents of PV areas will be lost or corrupted and dates and times will be reset. When restarting operation after the power supply has been interrupted for an extended period of time, check the system in advance to confirm that no errors will occur.

Handling

- Connect connectors only after confirming that the direction or polarity is correct.
- Failures could result if dust or dirt enters the ZEN. Always connect the connector cover to the computer connector whenever it is not being used.
- Do not remove the label from the left side of the CPU Unit if a Battery Unit is not mounted.

Other

- The execution of the ladder program in the ZEN is different from that for other PLCs. Refer to *Difference between ZEN Programmable Relays and PLC Ladder Program Execution* on page 32.
- Abide by all local ordinances and regulations when disposing of the ZEN.
- The Battery Unit (ZEN-BAT01, sold separately) contains a lithium battery. Observe all applicable legal requirements for your area when disposing of the lithium battery.

ALL DIMENSIONS SHOWN ARE IN MILLIMETERS.

To convert millimeters into inches, multiply by 0.03937. To convert grams into ounces, multiply by 0.03527.

In the interest of product improvement, specifications are subject to change without notice.

Terms and Conditions Agreement

Read and understand this catalog.

Please read and understand this catalog before purchasing the products. Please consult your OMRON representative if you have any questions or comments.

Warranties.

(a) Exclusive Warranty. Omron's exclusive warranty is that the Products will be free from defects in materials and workmanship for a period of twelve months from the date of sale by Omron (or such other period expressed in writing by Omron). Omron disclaims all other warranties, express or implied.

(b) Limitations. OMRON MAKES NO WARRANTY OR REPRESENTATION, EXPRESS OR IMPLIED, ABOUT NON-INFRINGEMENT, MERCHANTABILITY OR FITNESS FOR A PARTICULAR PURPOSE OF THE PRODUCTS. BUYER ACKNOWLEDGES THAT IT ALONE HAS DETERMINED THAT THE PRODUCTS WILL SUITABLY MEET THE REQUIREMENTS OF THEIR INTENDED USE.

Omron further disclaims all warranties and responsibility of any type for claims or expenses based on infringement by the Products or otherwise of any intellectual property right. (c) Buyer Remedy. Omron's sole obligation hereunder shall be, at Omron's election, to (i) replace (in the form originally shipped with Buyer responsible for labor charges for removal or replacement thereof) the non-complying Product, (ii) repair the non-complying Product, or (iii) repay or credit Buyer an amount equal to the purchase price of the non-complying Product; provided that in no event shall Omron be responsible for warranty, repair, indemnity or any other claims or expenses regarding the Products unless Omron's analysis confirms that the Products were properly handled, stored, installed and maintained and not subject to contamination, abuse, misuse or inappropriate modification. Return of any Products by Buyer must be approved in writing by Omron before shipment. Omron Companies shall not be liable for the suitability or unsuitability or the results from the use of Products in combination with any electrical or electronic components, circuits, system assemblies or any other materials or substances or environments. Any advice, recommendations or information given orally or in writing, are not to be construed as an amendment or addition to the above warranty.

See <http://www.omron.com/global/> or contact your Omron representative for published information.

Limitation on Liability: Etc.

OMRON COMPANIES SHALL NOT BE LIABLE FOR SPECIAL, INDIRECT, INCIDENTAL, OR CONSEQUENTIAL DAMAGES, LOSS OF PROFITS OR PRODUCTION OR COMMERCIAL LOSS IN ANY WAY CONNECTED WITH THE PRODUCTS, WHETHER SUCH CLAIM IS BASED IN CONTRACT, WARRANTY, NEGLIGENCE OR STRICT LIABILITY.

Further, in no event shall liability of Omron Companies exceed the individual price of the Product on which liability is asserted.

Suitability of Use.

Omron Companies shall not be responsible for conformity with any standards, codes or regulations which apply to the combination of the Product in the Buyer's application or use of the Product. At Buyer's request, Omron will provide applicable third party certification documents identifying ratings and limitations of use which apply to the Product. This information by itself is not sufficient for a complete determination of the suitability of the Product in combination with the end product, machine, system, or other application or use. Buyer shall be solely responsible for determining appropriateness of the particular Product with respect to Buyer's application, product or system. Buyer shall take application responsibility in all cases.

NEVER USE THE PRODUCT FOR AN APPLICATION INVOLVING SERIOUS RISK TO LIFE OR PROPERTY OR IN LARGE QUANTITIES WITHOUT ENSURING THAT THE SYSTEM AS A WHOLE HAS BEEN DESIGNED TO ADDRESS THE RISKS, AND THAT THE OMRON PRODUCT(S) IS PROPERLY RATED AND INSTALLED FOR THE INTENDED USE WITHIN THE OVERALL EQUIPMENT OR SYSTEM.

Programmable Products.

Omron Companies shall not be responsible for the user's programming of a programmable Product, or any consequence thereof.

Performance Data.

Data presented in Omron Company websites, catalogs and other materials is provided as a guide for the user in determining suitability and does not constitute a warranty. It may represent the result of Omron's test conditions, and the user must correlate it to actual application requirements. Actual performance is subject to the Omron's Warranty and Limitations of Liability.

Change in Specifications.

Product specifications and accessories may be changed at any time based on improvements and other reasons. It is our practice to change part numbers when published ratings or features are changed, or when significant construction changes are made. However, some specifications of the Product may be changed without any notice. When in doubt, special part numbers may be assigned to fix or establish key specifications for your application. Please consult with your Omron's representative at any time to confirm actual specifications of purchased Product.

Errors and Omissions.

Information presented by Omron Companies has been checked and is believed to be accurate; however, no responsibility is assumed for clerical, typographical or proofreading errors or omissions.