

# Product datasheet

Specifications



Head for illuminated push button,  
Harmony XB5, white, 30mm,  
universal LED, plain lens

ZB5FW313

## Main

Range of product	Harmony XB5
Product or component type	Head for illuminated push-button
Device short name	ZB5
Product compatibility	Universal LED
Bezel material	Dark grey plastic
Mounting diameter	30.5 mm
Sale per indivisible quantity	1
Head type	Built-in-flush
Shape of signaling unit head	Round
Type of operator	spring return
Operator profile	White flush, unmarked
Operator additional information	With plain lens

## Complementary

CAD overall width	37 mm
CAD overall height	37 mm
CAD overall depth	30 mm
Product weight	0.017 kg
Resistance to high pressure washer	7000000 Pa at 55 °C, distance : 0.1 m
Mechanical durability	10000000 cycles
Main group	Illum push-button
Group of product	Flush push integral LED
Cap/operator or lens colour	White
Marking	Unmarked
Electrical composition code	M1 for <6 contacts using single blocks in front mounting with integral LED M2 for <6 contacts using single and double blocks in front mounting with integral LED M6 for <2 contacts using single blocks in front mounting with integral LED and transformer M10 for <2 contacts using single blocks in front mounting with integral LED MF1 for <2 contacts using single blocks in front mounting with integral LED
Device presentation	Basic element

## Environment

Protective treatment	TC
----------------------	----

<b>Ambient air temperature for storage</b>	-40...70 °C
<b>Ambient air temperature for operation</b>	-40...70 °C
<b>Overvoltage category</b>	Class II conforming to IEC 60536
<b>IP degree of protection</b>	IP66 conforming to IEC 60529 IP67 IP69 IP69K
<b>NEMA degree of protection</b>	NEMA 13 NEMA 4X
<b>IK degree of protection</b>	IK03 conforming to IEC 62262
<b>Standards</b>	UL 508 IEC 60947-5-1 CSA C22.2 No 14 GB 14048.5 IEC 60947-5-4 JIS C8201-5-1 IEC 60947-1 JIS C8201-1 ISO 21702 ISO 22196:2011
<b>Product certifications</b>	CSA BV DNV LROS (Lloyds register of shipping) UL listed GL
<b>Vibration resistance</b>	5 gn (f= 2...500 Hz) conforming to IEC 60068-2-6
<b>Shock resistance</b>	30 gn (duration = 18 ms) for half sine wave acceleration conforming to IEC 60068-2-27 50 gn (duration = 11 ms) for half sine wave acceleration conforming to IEC 60068-2-27

## Packing Units

<b>Unit Type of Package 1</b>	PCE
<b>Number of Units in Package 1</b>	1
<b>Package 1 Height</b>	5.7 cm
<b>Package 1 Width</b>	4.5 cm
<b>Package 1 Length</b>	5.3 cm
<b>Package 1 Weight</b>	23.0 g
<b>Unit Type of Package 2</b>	S02
<b>Number of Units in Package 2</b>	40
<b>Package 2 Height</b>	15.0 cm
<b>Package 2 Width</b>	30.0 cm
<b>Package 2 Length</b>	40.0 cm
<b>Package 2 Weight</b>	1.262 kg

## Sustainability

**Green Premium™ label** is Schneider Electric's commitment to delivering products with best-in-class environmental performance. Green Premium promises compliance with the latest regulations, transparency on environmental impacts, as well as circular and low-CO<sub>2</sub> products.

**Guide to assessing product sustainability** is a white paper that clarifies global eco-label standards and how to interpret environmental declarations.

[Learn more about Green Premium >](#)

[Guide to assess a product's sustainability >](#)

## Well-being performance

✓ Reach Free Of Svhc

---

✓ Toxic Heavy Metal Free

---

✓ Mercury Free

---

✓ Rohs Exemption Information [Yes](#)

---

**Reach Regulation** [REACH Declaration](#)

---

**Eu Rohs Directive** Pro-active compliance (Product out of EU RoHS legal scope)  
[EU RoHS Declaration](#)

---

**China Rohs Regulation** [China RoHS declaration](#)

---

Dimensions Drawings

Dimensions

---

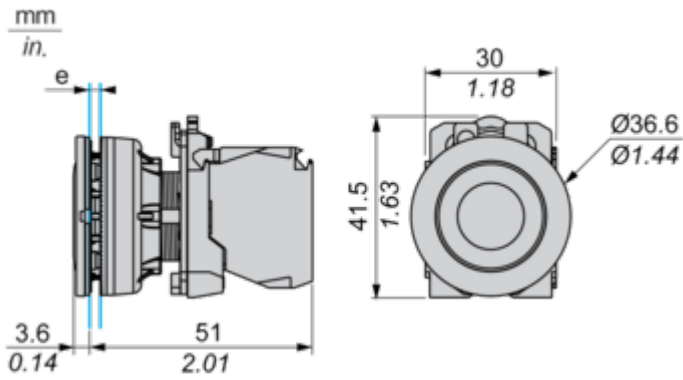

e: Clamping thickness: 1 to 6 mm / 0.04 to 0.24 in.

Mounting and Clearance

Panel Cut-out for Pushbuttons, Switches and Pilot Lights (Finished Holes, Ready for Installation)

Connection by Screw Clamp Terminals or Plug-in Connectors

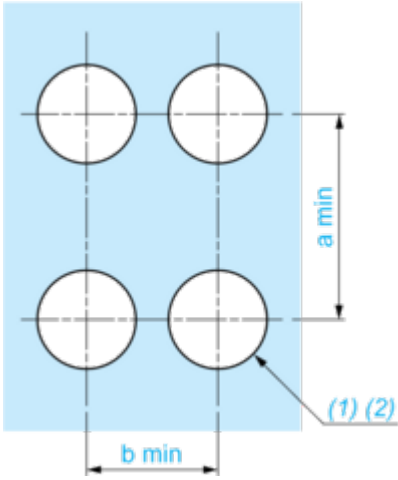

(1) Diameter on finished panel or support

(2)  $\varnothing 30.75$  mm recommended ( $\varnothing 30.5 \begin{smallmatrix} +0.5 \\ 0 \end{smallmatrix}$ ) /  $\varnothing 1.21$  in. recommended ( $\varnothing 1.20$  in.  $\begin{smallmatrix} +0.0196 \\ 0 \end{smallmatrix}$ )

Connections	a in mm	a in in.	b in mm	b in in.
By screw clamp terminals or plug-in connector	40	1.57	40	1.57
By Faston connectors	45	1.77	40	1.57

Technical Description

Electrical Composition Corresponding to Codes M1 and M7

---



Electrical Composition Corresponding to Codes M2 and M8

---

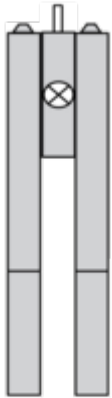

Electrical Composition Corresponding to Codes M6 and P2

---

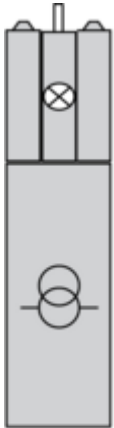



Electrical Composition Corresponding to Codes M5, M10, MF1, MR1 and MF2

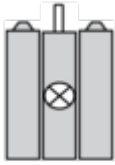

**Legend**

---

Single contact



Double contact



Light block



Possible location



Technical Illustration

Dimensions

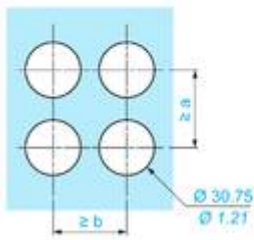
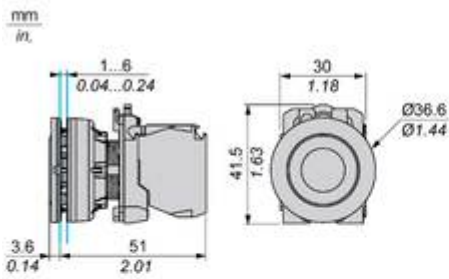

		a (mm)	a (in.)	b (mm)	b (in.)
		40	1.57	40	1.57
ZBE.....	ZBV.....				
		45	1.77	40	1.57
ZBE.....3	ZBV.....3				
		40	1.57	40	1.57
ZBE.....4	ZBV.....4				

Offer Marketing Illustration

Product benefits / Features

---

### Features Harmony XB5



- 

Quick and easy assembly and disassembly
- 

Excellent mechanical connection with operator head
- 

Various types of connection: screw clamp, connector, Faston connector, spring terminal, or printed circuit board
- 

Large set of accessories to customize your panels
- 

Robustness to withstand harsh environments

Offer Marketing Illustration

Product benefits / Features

---

## Technical Benefits

### Harmony XB5

Conformity with IEC, UL, CSA, CCC EAC, and JIS standards, as well as CE marking and marine approvals

Up to IP66, 67, 69, 69K, and type 4X protection ratings

High vibration resistance with shake-proof terminal screws



Operating temperature from -40°C to 70°C

Shock protection level up to IK06

Secure switching of inductive or heavy DC loads directly – 100 000 operations at 10A, 24V dc

Image of product / Alternate images

Alternative

---





