

M12 Molded Sensor I/O Connectors

XS2

User-Friendly, Watertight Connectors
for Industrial Automation Equipment
Reduce Wiring and Maintenance

- Surpasses IP67 requirements and ensures 94V-0 fire retardant rating
- Quick disconnect simplifies maintenance and reduces down time
- Extension cable has one female socket, one male plug
- Single-end I/O connector has a female socket with attached cable
- Double-ended connector comes with a socket (female) on one end and a plug (male) on the other end



Ordering Information

■ EXTENSION CABLE WITH DOUBLE-ENDED, MOLDED SENSOR CONNECTORS

Shape	Number of conductors	Cable length	Part number
Straight-to-straight	4	2 m (6.56 ft)	XS2W-D421-D81-A
		5 m (16.40 ft)	XS2W-D421-G81-A

■ DIMENSIONS

Unit: mm (inch)

XS2W-D421 Connector on Each End

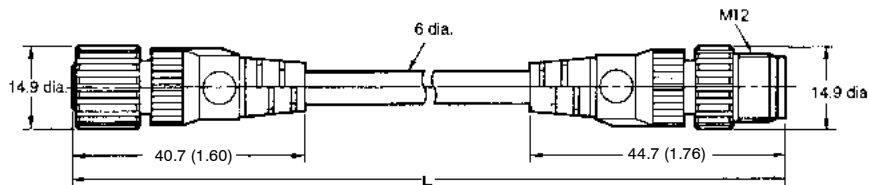

Part number	L
XS2W-D421-D81-A	2 m
XS2W-D421-G81-A	5 m

■ WIRING DIAGRAM

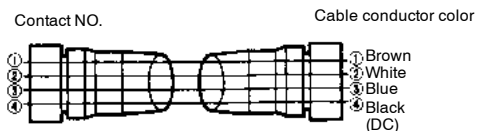

■ SINGLE-ENDED, MOLDED SENSOR CONNECTORS DC

Shape	Number of conductors	Cable length	Part number
Straight connector	3	2 m (6.56 ft)	XS2F-D421-DC0-A
		5 m (16.40 ft)	XS2F-D421-GC0-A
	4	2 m (6.56 ft)	XS2F-D421-D80-A
		5 m (16.40 ft)	XS2F-D421-G80-A
Right angle connector	3	5 m (16.40 ft)	XS2F-D422-GC0-A
	4	2 m (6.56 ft)	XS2F-D422-D80-A
		5 m (16.40 ft)	XS2F-D422-G80-A

■ SINGLE-ENDED, MOLDED SENSOR CONNECTORS AC

Shape	Number of conductors	Cable length	Part number
Straight connector	4	2 m (6.56 ft)	XS2F-A421-D90-A
		5 m (16.40 ft)	XS2F-A421-G90-A

■ DIMENSIONS

Unit: mm (inch)

XS2F-D421
Straight Connectors

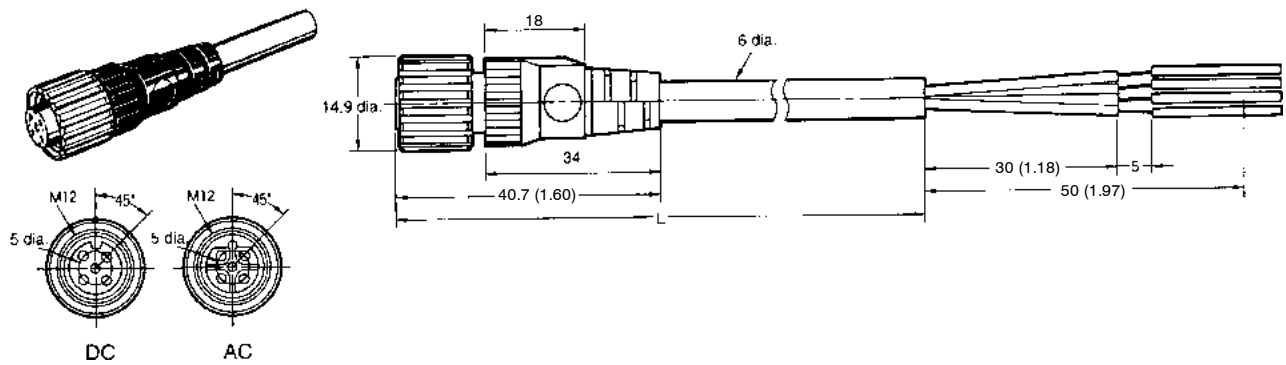

XS2F-D422
Right Angle Connectors

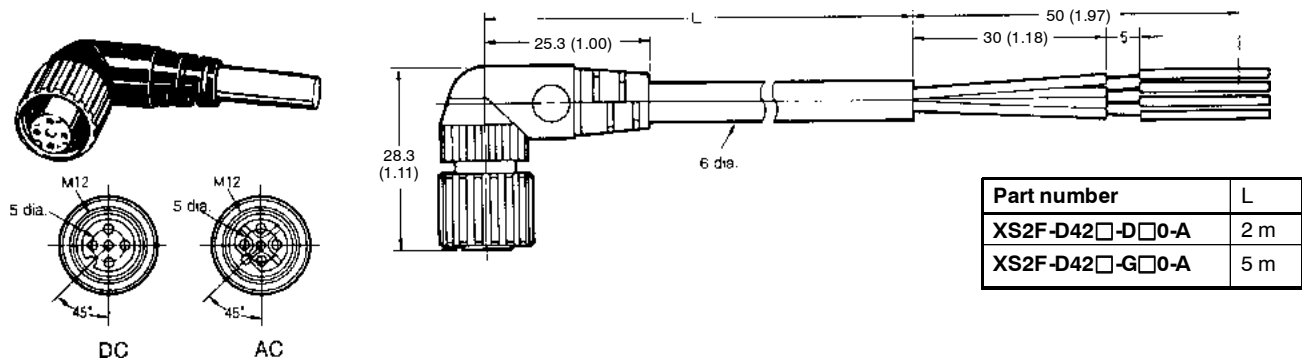

Part number	L
XS2F-D42□-D□0-A	2 m
XS2F-D42□-G□0-A	5 m

■ WIRING DIAGRAMS

Three-conductor models

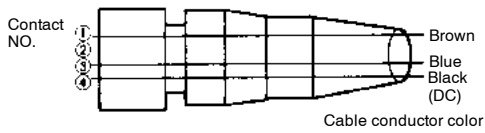

Four-conductor models

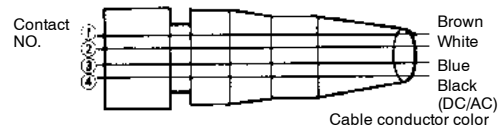

■ PLUG AND SOCKET CONNECTOR ASSEMBLIES

Shape	Description	Connection method	Part number
Straight connector	Socket (female)	Screw-on	XS2C-D4S1
	Plug (male)		XS2G-D4S1

■ DIMENSIONS

Unit: mm (inch)

XS2C-D4S1
Straight Connector Socket

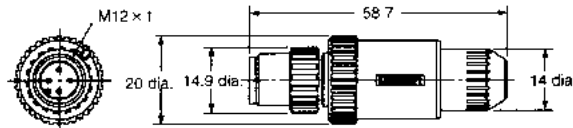

XS2G-D4SA
Straight Connector Plug

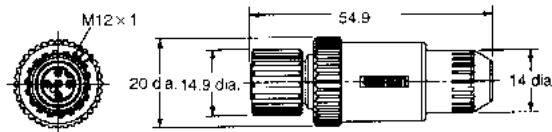
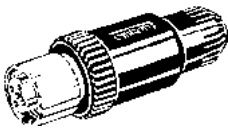

Construction

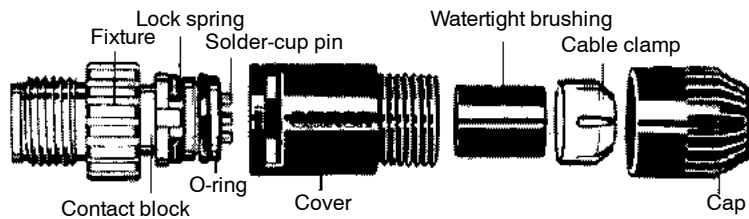

Specifications

■ MATERIALS AND FINISH

Contact block	PBT resin (UL94V-0). Light gray finish
Contact	Brass/nickel base, 0.4 μm (0.016 μin . gold plating)
Fixtures	Nickel-plated brass
Cap	Polyamide resin (UL94-0), black finish
Cable clamp	Polyamide resin (UL94-0). 6 mm (0.24 in): white finish, 4 mm (0.16 in): black finish
Lock spring	LCP resin
Waterproof bushing	Rubber
Screw	Nickel-plated iron (See Note.)
Screw plate	Nickel-plated steel (See Note.)
Cover	Assembled: PBT resin (UL94V-0), black finish Molded: Polyvinyl chloride (UL94V-0), black finish
Cover lock	PBT resin (UL94V-0), black finish (See Note.)
Ring	Steel
O-ring	Rubber

Note: Cover lock, screw and screw plate only pertain to models XS2G and XS2C.

■ CHARACTERISTICS

Current rating	3 A								
Voltage rating	125 VDC								
Contact resistance	40 m Ω max., 20 mV max., 100 mA mx. (See Note.)								
Insulation resistance	1000 M Ω at 500 VDC								
Dielectric strength	1500 VAC for 1 minute Leakage current: 1 mA max.								
Enclosure rating	IEC IP67								
Electrical protection	Class 0								
Insertion tolerance	200 times minimum								
Vibration resistance	At 10 to 500 Hz, 1.5 mm amplitude (or 10 G), no current shut-off for more than 1 μs								
Assembled fixture strength	Tensile: 98 N (10 kgf) for 15 s Torsion: 0.98 N m (10 kgf cm) for 15 sec.								
Cable holding	<table border="0"> <tr> <td>Cable diameter</td> <td>Strength</td> </tr> <tr> <td>6 mm (0.24 in)</td> <td>98 N (10 kgf) for 15 s</td> </tr> <tr> <td>4 to 5 mm (0.16 to 0.2 in)</td> <td>49 N (5 kgf) for 15 s</td> </tr> <tr> <td>3 mm (0.1 in)</td> <td>29 N (3 kgf) for 15 s</td> </tr> </table>	Cable diameter	Strength	6 mm (0.24 in)	98 N (10 kgf) for 15 s	4 to 5 mm (0.16 to 0.2 in)	49 N (5 kgf) for 15 s	3 mm (0.1 in)	29 N (3 kgf) for 15 s
Cable diameter	Strength								
6 mm (0.24 in)	98 N (10 kgf) for 15 s								
4 to 5 mm (0.16 to 0.2 in)	49 N (5 kgf) for 15 s								
3 mm (0.1 in)	29 N (3 kgf) for 15 s								
Ambient operating temperature	-25°C to 70°C (-13°F to 158°F)								

Note: The combined contact resistance of XS2G and XS2C at a cable length of 50 mm is 30 m Ω max., at 20 mVDC max, 100 mA max.

Installation

■ ASSEMBLING XS2C/G-D4S1 PLUG AND SOCKET

Each terminal is assigned a number. Insert the wires into the appropriate terminals.

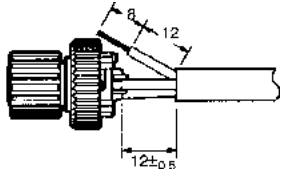

Tighten each terminal with a small jeweler's screwdriver to the specified torque (4 to 5 kgf • cm)

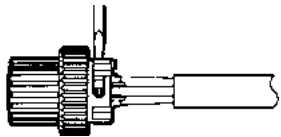

Align the arrow head on the cover to the arrow head on the contact block.
Tighten the screw until the cover lock latches onto the contact block tightly.

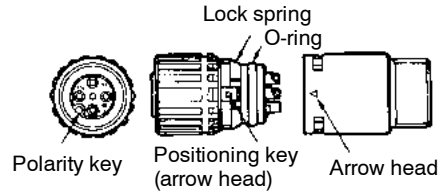

Tighten the cap by hand only (4 to 5 kgf • cm).

Precautions

■ TIGHTENING THE CAP

Tighten the cap firmly by hand (4 to 5 kgf • cm). Use of pliers or other tools may damage the cap.

If the cap is not securely tightened, the following may occur:
Enclosure rating of IP67 will be compromised
Vibration may loosen the cap.

■ INSERTING AND REMOVING THE CONNECTOR

Turn off the power before inserting or removing the connector.

Complete the following steps before mating any connector:

Fully insert the mating parts

Tighten the anchor. This will prevent damage to the threads.

Firmly tighten (4 to 5 kgf • cm) the anchors by hand only. Tighten until threads can no longer be seen.
Only loosen the anchor when removing the connector. Do not loosen the cap.

Loosen the anchor in the direction of the groove.

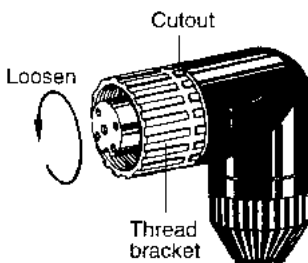

■ PROTECTIVE HOUSING

Do not use a connector that has an enclosure rating of IP67 in an environment where it is continually under stress. The protection rating may decrease.

Do not use the connector in an application that requires the connector to be under water continually. Connectors with an enclosure rating of IP67 are not completely watertight.

The housing is made of plastic. Do not step on it or put heavy objects on top of it.

■ STORAGE

Store connectors in a moisture- and dust-free environment.
Do not store connectors near ammonia gas, sulfuric gas, etc.

NOTE: DIMENSIONS SHOWN ARE IN MILLIMETERS. To convert millimeters to inches divide by 25.4.

OMRON[®]

OMRON ELECTRONICS LLC

One East Commerce Drive
Schaumburg, IL 60173

1-800-55-OMRON

OMRON ON-LINE

Global - <http://www.omron.com>
USA - <http://www.omron.com/oei>
Canada - <http://www.omron.com/oci>

OMRON CANADA, INC.

885 Milner Avenue
Scarborough, Ontario M1B 5V8

416-286-6465