

XS218B4PBL2

Inductive proximity sensors XS, inductive sensor XS2 M18, L41mm, brass, Sn16mm, 12...24 VDC, cable 2 m



Main

Range of product	Telemecanique Inductive proximity sensors XS
Series name	General purpose
Sensor type	Inductive proximity sensor
Device application	Mobile equipment
Sensor name	XS2
Sensor design	Cylindrical M18
Size	41 mm
Body type	Fixed
Detector flush mounting acceptance	Non flush mountable
Material	Metal
Type of output signal	Discrete
Wiring technique	3-wire
[Sn] nominal sensing distance	16 mm
Discrete output function	1 NC
Output circuit type	DC
Discrete output type	PNP
Electrical connection	Cable
Cable length	2 m
[Us] rated supply voltage	12...24 V DC with reverse polarity protection
Switching capacity in mA	<= 200 mA with overload and short-circuit protection
IP degree of protection	IP65 conforming to IEC 60529 IP67 conforming to DIN 40050 IP69K

Complementary

Thread type	M18 x 1
Detection face	Frontal
Front material	PPS
Enclosure material	Nickel plated brass
Sensing range	> 15...40 mm
Operating zone	0...12.8 mm
Differential travel	1...15% of Sr
Cable composition	3 x 0.34 mm ²
Wire insulation material	PVC
Status LED	Output state: 1 LED (yellow)
Supply voltage limits	10...36 V DC
Switching frequency	<= 1000 Hz
Maximum voltage drop	<2 V (closed)
Current consumption	<= 10 mA no-load
Maximum delay first up	15 ms
Maximum delay response	0.3 ms
Maximum delay recovery	0.7 ms
Marking	CE
Threaded length	21 mm

Length	41 mm
Net weight	0.105 kg

Environment

Product certifications	CSA[RETURN]UL[RETURN]E2
Ambient air temperature for operation	-25...70 °C
Ambient air temperature for storage	-40...85 °C
Vibration resistance	25 gn amplitude = +/- 2 mm (f = 10...55 Hz) conforming to IEC 60068-2-6
Shock resistance	50 gn for 11 ms conforming to IEC 60068-2-27

Packing Units

Unit Type of Package 1	PCE
Number of Units in Package 1	1
Package 1 Height	4.200 cm
Package 1 Width	9.700 cm
Package 1 Length	13.000 cm
Package 1 Weight	107.000 g
Unit Type of Package 2	S02
Number of Units in Package 2	22
Package 2 Height	15 cm
Package 2 Width	30 cm
Package 2 Length	40 cm
Package 2 Weight	2.695 kg

Offer Sustainability

Sustainable offer status	Green Premium product
Circularity Profile	 End of Life Information
California proposition 65	WARNING: This product can expose you to chemicals including: Diisononyl phthalate (DINP), which is known to the State of California to cause cancer, and Di-isodecyl phthalate (DIDP), which is known to the State of California to cause birth defects or other reproductive harm. For more information go to www.P65Warnings.ca.gov
For all Reach Rohs enquiries contact us at	sustainability@tesensors.com

Dimensions

Pre-cabled

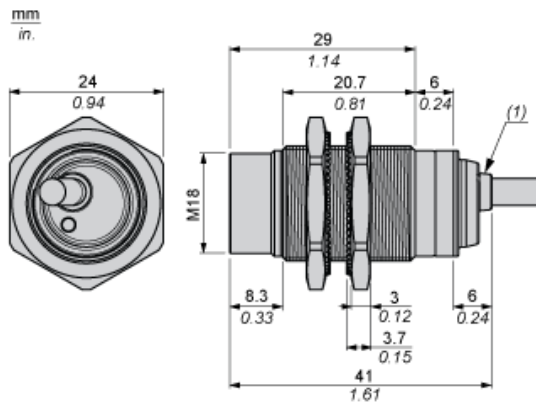

(1) Yellow LED (Output state indication)

Mounting and Clearance

Minimum Mounting Distances

Side by Side

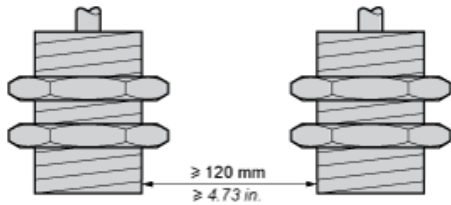

Face to Face

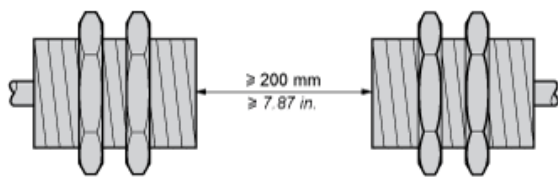

Facing a Metal Object

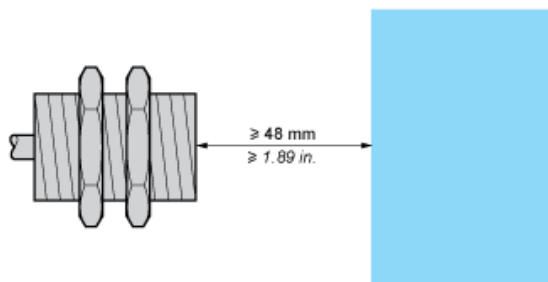

Mounted in a Metal Support

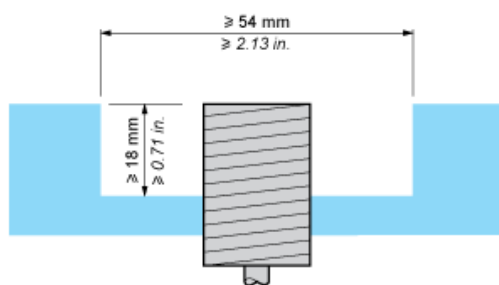

Connection and Schema

Wiring Schemes

PNP 3-wire

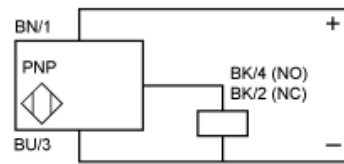

BN : Brown
BK : Black
BU : Blue

Performance Curves

Standard Steel Target: 24 x 24 x 1 mm

Operating zone: 0...12.8 mm

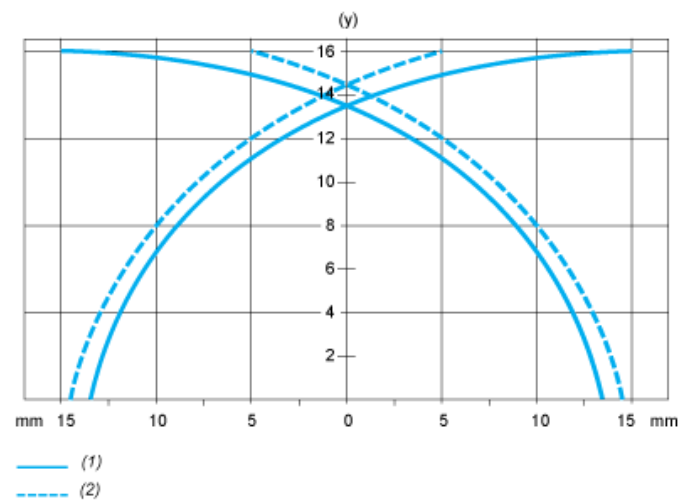

- (y) Sensing distance in mm
- (1) Pick-up points
- (2) Drop-out points (object approaching from the side)