

# XS218B4NAM12

Inductive proximity sensors XS, inductive sensor XS2 M18, L51mm, brass, Sn16mm, 12...24 VDC, M12



## Main

Range of product	Telemecanique Inductive proximity sensors XS
Series name	General purpose
Sensor type	Inductive proximity sensor
Device application	Mobile equipment
Sensor name	XS2
Sensor design	Cylindrical M18
Size	51 mm
Body type	Fixed
Detector flush mounting acceptance	Non flush mountable
Material	Metal
Type of output signal	Discrete
Wiring technique	3-wire
[Sn] nominal sensing distance	16 mm
Discrete output function	1 NO
Output circuit type	DC
Discrete output type	NPN
Electrical connection	Male connector M12, 4 pins
[Us] rated supply voltage	12...24 V DC with reverse polarity protection
Switching capacity in mA	<= 200 mA with overload and short-circuit protection
IP degree of protection	IP65 conforming to IEC 60529 IP67 conforming to DIN 40050 IP69K

## Complementary

Thread type	M18 x 1
Detection face	Frontal
Front material	PPS
Enclosure material	Nickel plated brass
Sensing range	> 15...40 mm
Operating zone	0...12.8 mm
Differential travel	1...15% of Sr
Status LED	Output state: 1 LED (yellow)
Supply voltage limits	10...36 V DC
Switching frequency	<= 1000 Hz
Maximum voltage drop	<2 V (closed)
Current consumption	<= 10 mA no-load
Maximum delay first up	15 ms
Maximum delay response	0.3 ms
Maximum delay recovery	0.7 ms
Marking	CE
Threaded length	21 mm
Length	51 mm
Net weight	0.052 kg

## Environment

Product certifications	E2[RETURN]UL[RETURN]CSA
Ambient air temperature for operation	-25...70 °C
Ambient air temperature for storage	-40...85 °C
Vibration resistance	25 gn amplitude = +/- 2 mm (f = 10...55 Hz) conforming to IEC 60068-2-6
Shock resistance	50 gn for 11 ms conforming to IEC 60068-2-27

## Packing Units

Unit Type of Package 1	PCE
Number of Units in Package 1	1
Package 1 Height	6.400 cm
Package 1 Width	4.100 cm
Package 1 Length	9.600 cm
Package 1 Weight	55.000 g
Unit Type of Package 2	S02
Number of Units in Package 2	22
Package 2 Height	15 cm
Package 2 Width	30 cm
Package 2 Length	40 cm
Package 2 Weight	1.557 kg

## Offer Sustainability

Sustainable offer status	Green Premium product
Circularity Profile	<a href="#">End of Life Information</a>
California proposition 65	WARNING: This product can expose you to chemicals including: Diisononyl phthalate (DINP), which is known to the State of California to cause cancer, and Di-isodecyl phthalate (DIDP), which is known to the State of California to cause birth defects or other reproductive harm. For more information go to <a href="http://www.P65Warnings.ca.gov">www.P65Warnings.ca.gov</a>
For all Reach Rohs enquiries contact us at	<a href="mailto:sustainability@tesensors.com">sustainability@tesensors.com</a>

Dimensions

With M12 Connector

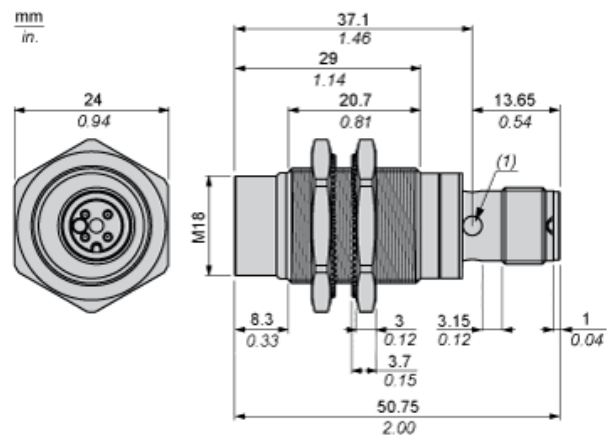

(1) Yellow LED (Output state indication)

---

Mounting and Clearance

---

Minimum Mounting Distances

Side by Side

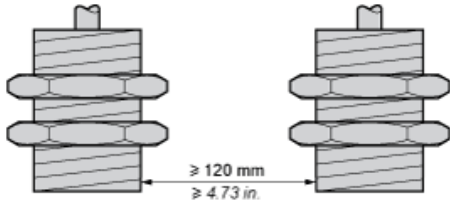

Face to Face

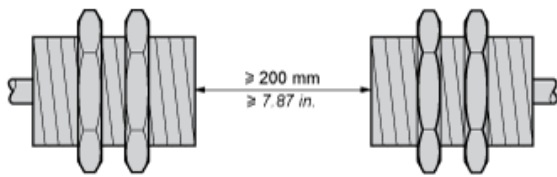

Facing a Metal Object

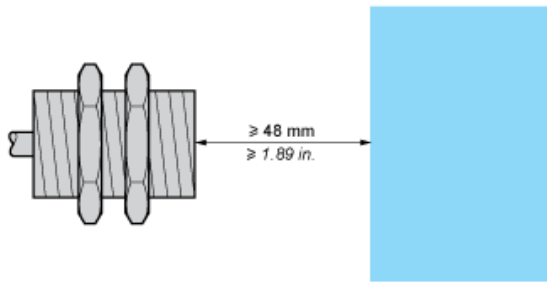

Mounted in a Metal Support

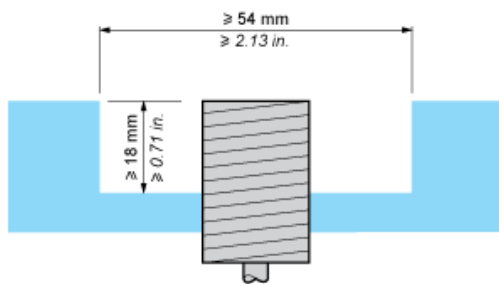

---

## Connection and Schema

---

### Wiring Schemes

M12 connector

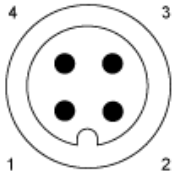

---

## Connection and Schema

---

### Wiring Schemes

NPN 3-wire

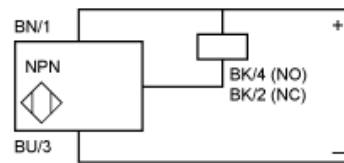

BN : Brown  
BK : Black  
BU : Blue

## Performance Curves

Standard Steel Target: 24 x 24 x 1 mm

Operating zone: 0...12.8 mm

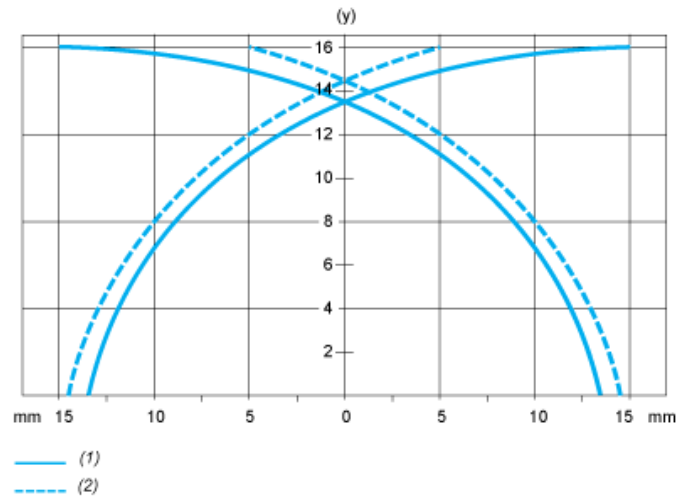

- (y) Sensing distance in mm
- (1) Pick-up points
- (2) Drop-out points (object approaching from the side)