

Product datasheet

Specifications



3-phase control relay, Harmony Control Relays, 5A , 2NO, phase failure detection, 24..240V AC DC

RM35TM50MW

Main

range of product	Harmony Control Relays
Relay type	Motor temperature control relay
product or component type	Motor temperature control relay
Product specific application	For 3-phase supply
Relay name	RM35TM
Relay monitored parameters	Phase sequence Motor temperature via PTC probe Phase failure detection
time delay	Without
Switching capacity in VA	1250 VA
Measurement range	208...480 V AC 15...3100 Ohm
Contacts type and composition	2 NO
[Uc] control circuit voltage	24...240 V

Complementary

Reset time	10000 ms output
Maximum switching voltage	250 V AC 250 V DC
Minimum switching current	10 mA at 5 V DC
Maximum switching current	5 A AC 5 A DC
[Un] rated nominal voltage	24...240 V AC/DC 50/60 Hz, non self-powered
Supply voltage limits	20.4...264 V AC 20.4...264 V DC
Power consumption in VA	0...4 VA at 24...240 V AC
power consumption	0.5 W DC
Control circuit frequency	50...60 Hz +/- 10 %
Resistance across terminals	602 mOhm
Output contacts	2 NO
Nominal output current	5 A
Measurement voltage limits	176...528 V AC
delay at power up	500 ms
Voltage range	176...528 V

Response time	> 50 ms (input Y1 (contact Y1-T1) and push-button)
[Uc] control circuit voltage	<= 3.6 V of temperature control circuit (T1-T2 terminals open)
Short-circuit current	0.007 A temperature sensing circuit (T1-T2 terminals short circuited)
Maximum resistance	1500 Ohm for temperature sensor at 20 °C
Tripping threshold	3100 Ohm +/- 10 % for temperature control circuit
Reset threshold	1650 Ohm +/- 10 % for temperature control circuit
marking	CE
Overvoltage category	III conforming to IEC 60664-1
Insulation resistance	> 500 MOhm at 500 V DC between supply and relay output conforming to IEC 60255-5 > 500 MOhm at 500 V DC between measurement and relay output conforming to IEC 60664-1 > 1 MOhm at 500 V DC between supply and measurement conforming to IEC 60255-5 > 500 MOhm at 500 V DC between supply and relay output conforming to IEC 60664-1 > 500 MOhm at 500 V DC between measurement and relay output conforming to IEC 60255-5 > 1 MOhm at 500 V DC between supply and measurement conforming to IEC 60664-1
[Ui] rated insulation voltage	400 V conforming to IEC 60664-1
Supply frequency	50/60 Hz +/- 10 %
Operating position	Any position without derating
Connections - terminals	Screw terminals, 1 x 0.5...1 x 4 mm ² (AWG 20...AWG 11) solid without cable end Screw terminals, 2 x 0.5...2 x 2.5 mm ² (AWG 20...AWG 14) solid without cable end Screw terminals, 1 x 0.2...1 x 2.5 mm ² (AWG 24...AWG 12) flexible with cable end Screw terminals, 2 x 0.2...2 x 1.5 mm ² (AWG 24...AWG 16) flexible with cable end
Tightening torque	0.6...1 N.m conforming to IEC 60947-1
Housing material	Self-extinguishing plastic
Local signalling	LED (green) for power ON LED (yellow) for phase of relay (R2) LED (yellow) for temperature of relay (R1)
Mounting support	35 mm symmetrical DIN rail conforming to IEC 60715
Electrical durability	10000 cycles
Mechanical durability	30000000 cycles
Operating rate	<= 360 operations/hour full load
Utilisation category	AC-12 conforming to IEC 60947-5-1 AC-13 conforming to IEC 60947-5-1 AC-14 conforming to IEC 60947-5-1 AC-15 conforming to IEC 60947-5-1 DC-12 conforming to IEC 60947-5-1 DC-13 conforming to IEC 60947-5-1
Width	35 mm
net weight	0.13 kg
Control type	Without test button

Environment

Immunity to microbreaks	20 ms at 20.4 V
Electromagnetic compatibility	Emission standard for industrial environments conforming to IEC 61000-6-4 Emission standard for residential, commercial and light-industrial environments conforming to IEC 61000-6-3 Immunity for industrial environments conforming to IEC 61000-6-2

Standards	IEC 60255-6 IEC 60034-11-2
product certifications	GL UL GOST C-Tick CSA
Directives	73/23/EEC - low voltage directive 89/336/EEC - electromagnetic compatibility
ambient air temperature for storage	-40...70 °C
Ambient air temperature for operation	-20...50 °C
Relative humidity	95 % at 55 °C conforming to IEC 60068-2-30
Vibration resistance	0.35 mm (f= 5...57.6 Hz) conforming to IEC 60068-2-6 1 gn (f= 57.6...150 Hz) conforming to IEC 60255-21-1
Shock resistance	15 gn for 11 ms conforming to IEC 60255-21-1
IP degree of protection	IP20 (terminals) conforming to IEC 60529 IP30 (casing) conforming to IEC 60529
Pollution degree	3 conforming to IEC 60664-1
Dielectric test voltage	2 kV, 1 min AC 50 Hz
Non-dissipating shock wave	4 kV

Packing Units

Unit Type of Package 1	PCE
Number of Units in Package 1	1
Package 1 Height	4.300 cm
Package 1 Width	7.800 cm
Package 1 Length	9.500 cm
Package 1 Weight	127.000 g
Unit Type of Package 2	S03
Number of Units in Package 2	48
Package 2 Height	30.000 cm
Package 2 Width	30.000 cm
Package 2 Length	40.000 cm
Package 2 Weight	7.000 kg

Contractual warranty

Warranty	18 months
-----------------	-----------

Sustainability

Green Premium™ label is Schneider Electric's commitment to delivering products with best-in-class environmental performance. Green Premium promises compliance with the latest regulations, transparency on environmental impacts, as well as circular and low-CO₂ products.

Guide to assessing product sustainability is a white paper that clarifies global eco-label standards and how to interpret environmental declarations.

[Learn more about Green Premium >](#)

[Guide to assess a product's sustainability >](#)



Transparency

Well-being performance

 Mercury Free

Reach Regulation

[REACH Declaration](#)

Eu Rohs Directive

Pro-active compliance (Product out of EU RoHS legal scope)

China Rohs Regulation

[China RoHS declaration](#)

Environmental Disclosure

[Product Environmental Profile](#)

Circularity Profile

[End of Life Information](#)

Dimensions Drawings

3-Phase Supply and Motor Temperature Control Relays

Dimensions and Mounting

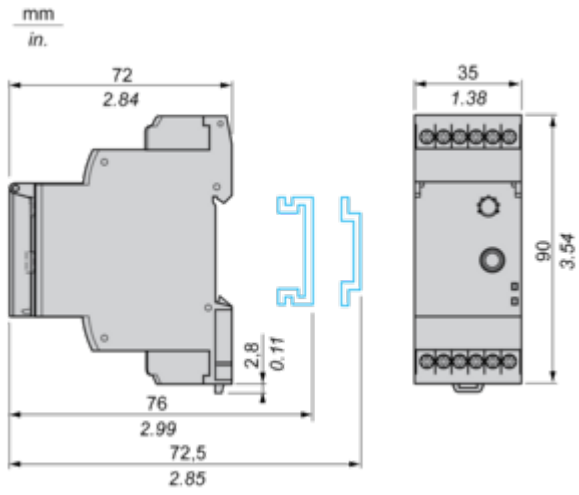

Connections and Schema

3-Phase Supply and Motor Temperature Control Relays

Wiring Diagram

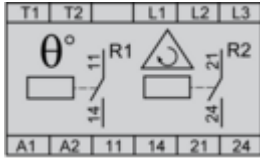

Technical Description

Function Diagrams

Phase Sequence Control and Phase Failure Detection (U measured < 0.7 x nominal supply voltage)

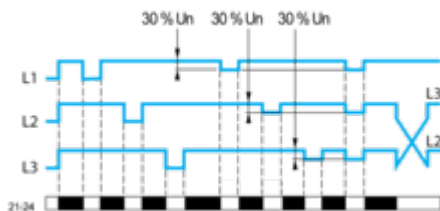

Motor Temperature Control via PTC Probe

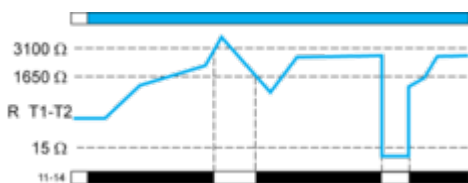

Legend

- Un Nominal 3-phase supply voltage
- R T1-T2 Resistance between terminals T1 and T2
- 11-14 R1 output relay connections
- Relay status: black color = energized.

NOTE: The temperature control relay can take up to 6 PTC (positive temperature coefficient) probes wired in series between terminals T1 and T2.

Technical Illustration

Dimensions

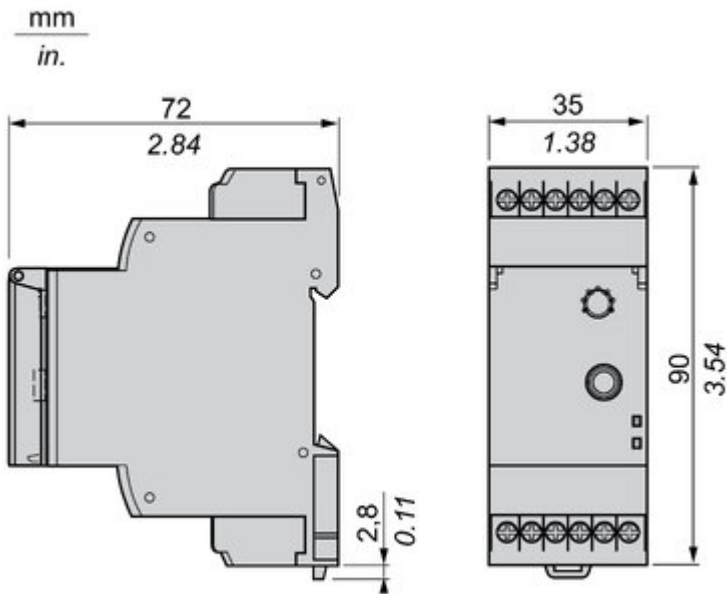

Offer Marketing Illustration

Product benefits / Features

Features

Harmony Control Relay



Wide monitoring parameters (phase, current, voltage, liquid level, frequency, speed, temperature, and pump control) to meet your application needs.



True RMS measurement that minimizes the possibility of unexpected trips from highly polluted networks (except RM17TG and RM22TG)





Experience unprecedented accuracy, predictive maintenance, and superior security.



Green Premium labelled products, promising compliance with the latest regulations, transparency on environmental impacts, as well as circular and low-CO₂ product



Compatible with a wide range of applications, such as hoisting, packaging, lifts, textile, pumping, and water.

Image of product / Alternate images

Alternative

