

Perfect fit for standard environments

- Embody two seemingly contradictory characteristics: value-for-money and high reliability
- All 372 Models
- Four different sizes: M8, M12, M18 and M30
- Single and double sensing distances, Shielded and unshielded
- A choice of short and long bodies, two connecting methods and four output types
- Operating temperature: -25°C to 70°C
- Water resistance: IP67
- With an all-round 360° visible indicator

 Refer to *Safety Precautions* on page 20.



For the most recent information on models that have been certified for safety standards, refer to your OMRON website.

Features

Wide Variation

- “Double Distance” Close at Hand
- Perfect Fit to Your Application Needs

With no less than 372 models in the family. You can choose the one that exactly meets your needs. E2B series can save cost & your time via single source.

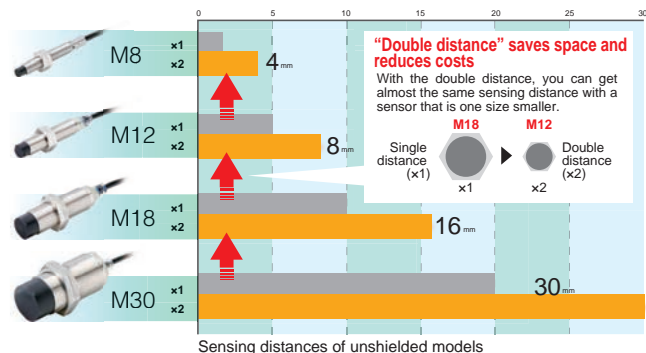
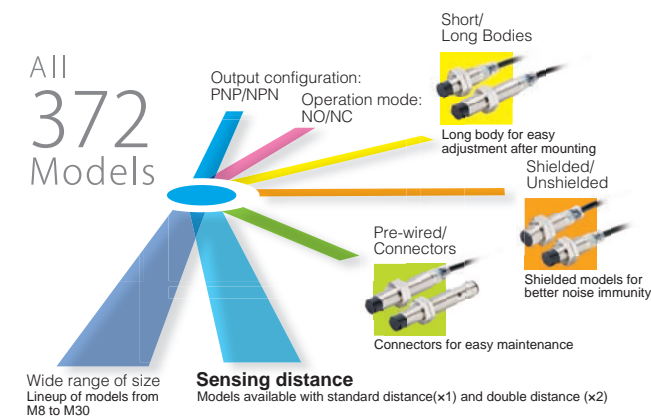

Reliable Performance

360-degree indication

Easy visibility for 360° even in dark locations so you can mount the sensor in any direction.

- * The 360-degree indication is only for Pre-wired Models of M12, M18, and M30.
- * The other models (Pre-wired Models of M8 and all the Connector Models) have 4 LEDs at 90-degree intervals, which realize clear visibility from a 360-degree angle.



Oil-mist environment resistant!



IP67

We have performed not only a specified test for rating the degree of protection (IP67) for catalogs, but also tests with oil mist which appears onsite. Simulation tests has been performed with attachment of high concentration of oil mist.

Degree of Protection	E2B	E2E (M8/M12/M18/M30 size)	Small Dia E2E (3 dia./4 dia./6.5 dia./M4/M5)
Water resistance	IP67	IP67 IP69K *1	IP67
Oil resistance	In oil-mist of soluble cutting oil diluted, 250 hours, the temperature of atmosphere is 23°C	Soaked in oil (soluble type and insoluble) 500 hours, temperature of oil 50°C	Soaked in insoluble oil 250 hours, temperature of oil 50°C

*1. There are so many kinds of E2E, not all IP69K rated. In detailed part#, please contact your OMRON representative.

E2B

Ordering Information

Size		Sensing distance	Connecting method (See note 1.)	Body length	Output configuration	Operation mode NO	Operation mode NC	
M8 (Stainless steel) (See note 2.)	Single	Shielded	1.5 mm	Pre-wired	Short	PNP	E2B-S08KS01-WP-B1 2M	E2B-S08KS01-WP-B2 2M
						NPN	E2B-S08KS01-WP-C1 2M	E2B-S08KS01-WP-C2 2M
					Long	PNP	E2B-S08LS01-WP-B1 2M	E2B-S08LS01-WP-B2 2M
					NPN	E2B-S08LS01-WP-C1 2M	E2B-S08LS01-WP-C2 2M	
				M8 Connector (3-pin)	Short	PNP	E2B-S08KS01-MC-B1	E2B-S08KS01-MC-B2
						NPN	E2B-S08KS01-MC-C1	E2B-S08KS01-MC-C2
		Long	PNP		E2B-S08LS01-MC-B1	E2B-S08LS01-MC-B2		
			NPN	E2B-S08LS01-MC-C1	E2B-S08LS01-MC-C2			
		Unshielded	2 mm	Pre-wired	Short	PNP	E2B-S08KN02-WP-B1 2M	E2B-S08KN02-WP-B2 2M
						NPN	E2B-S08KN02-WP-C1 2M	E2B-S08KN02-WP-C2 2M
					Long	PNP	E2B-S08LN02-WP-B1 2M	E2B-S08LN02-WP-B2 2M
					NPN	E2B-S08LN02-WP-C1 2M	E2B-S08LN02-WP-C2 2M	
	M8 Connector (3-pin)			Short	PNP	E2B-S08KN02-MC-B1	E2B-S08KN02-MC-B2	
					NPN	E2B-S08KN02-MC-C1	E2B-S08KN02-MC-C2	
		Long	PNP	E2B-S08LN02-MC-B1	E2B-S08LN02-MC-B2			
		NPN	E2B-S08LN02-MC-C1	E2B-S08LN02-MC-C2				
	Double	Shielded	2 mm	Pre-wired	Short	PNP	E2B-S08KS02-WP-B1 2M	E2B-S08KS02-WP-B2 2M
						NPN	E2B-S08KS02-WP-C1 2M	E2B-S08KS02-WP-C2 2M
					Long	PNP	E2B-S08LS02-WP-B1 2M	E2B-S08LS02-WP-B2 2M
					NPN	E2B-S08LS02-WP-C1 2M	E2B-S08LS02-WP-C2 2M	
				M8 Connector (3-pin)	Short	PNP	E2B-S08KS02-MC-B1	E2B-S08KS02-MC-B2
						NPN	E2B-S08KS02-MC-C1	E2B-S08KS02-MC-C2
		Long	PNP		E2B-S08LS02-MC-B1	E2B-S08LS02-MC-B2		
			NPN	E2B-S08LS02-MC-C1	E2B-S08LS02-MC-C2			
Unshielded		4 mm	Pre-wired	Short	PNP	E2B-S08KN04-WP-B1 2M	E2B-S08KN04-WP-B2 2M	
					NPN	E2B-S08KN04-WP-C1 2M	E2B-S08KN04-WP-C2 2M	
				Long	PNP	E2B-S08LN04-WP-B1 2M	E2B-S08LN04-WP-B2 2M	
				NPN	E2B-S08LN04-WP-C1 2M	E2B-S08LN04-WP-C2 2M		
	M8 Connector (3-pin)		Short	PNP	E2B-S08KN04-MC-B1	E2B-S08KN04-MC-B2		
				NPN	E2B-S08KN04-MC-C1	E2B-S08KN04-MC-C2		
Long		PNP	E2B-S08LN04-MC-B1	E2B-S08LN04-MC-B2				
	NPN	E2B-S08LN04-MC-C1	E2B-S08LN04-MC-C2					

Note: 1. Pre-wired Models are available in the cable lengths of 2 m and 5 m.





2. Material specifications for stainless steel housing case: 1.4305 (W.-No.), SUS 303 (AISI), 2346 (SS).

Size		Sensing distance	Connecting method (See note 1.)	Body length	Output configuration	Operation mode NO	Operation mode NC	
M12 (Brass)	Single	Shielded	2 mm	Pre-wired	Short	PNP	E2B-M12KS02-WP-B1 2M	E2B-M12KS02-WP-B2 2M
						NPN	E2B-M12KS02-WP-C1 2M	E2B-M12KS02-WP-C2 2M
					Long	PNP	E2B-M12LS02-WP-B1 2M	E2B-M12LS02-WP-B2 2M
					NPN	E2B-M12LS02-WP-C1 2M	E2B-M12LS02-WP-C2 2M	
				M12 Connector	Short	PNP	E2B-M12KS02-M1-B1	E2B-M12KS02-M1-B2
						NPN	E2B-M12KS02-M1-C1	E2B-M12KS02-M1-C2
		Long	PNP		E2B-M12LS02-M1-B1	E2B-M12LS02-M1-B2		
			NPN	E2B-M12LS02-M1-C1	E2B-M12LS02-M1-C2			
		Unshielded	5 mm	Pre-wired	Short	PNP	E2B-M12KN05-WP-B1 2M	E2B-M12KN05-WP-B2 2M
						NPN	E2B-M12KN05-WP-C1 2M	E2B-M12KN05-WP-C2 2M
					Long	PNP	E2B-M12LN05-WP-B1 2M	E2B-M12LN05-WP-B2 2M
					NPN	E2B-M12LN05-WP-C1 2M	E2B-M12LN05-WP-C2 2M	
	M12 Connector			Short	PNP	E2B-M12KN05-M1-B1	E2B-M12KN05-M1-B2	
					NPN	E2B-M12KN05-M1-C1	E2B-M12KN05-M1-C2	
		Long	PNP	E2B-M12LN05-M1-B1	E2B-M12LN05-M1-B2			
		NPN	E2B-M12LN05-M1-C1	E2B-M12LN05-M1-C2				
	Double	Shielded (See note 2.)	4 mm	Pre-wired	Short	PNP	E2B-M12KS04-WP-B1 2M	E2B-M12KS04-WP-B2 2M
						NPN	E2B-M12KS04-WP-C1 2M	E2B-M12KS04-WP-C2 2M
					Long	PNP	E2B-M12LS04-WP-B1 2M	E2B-M12LS04-WP-B2 2M
					NPN	E2B-M12LS04-WP-C1 2M	E2B-M12LS04-WP-C2 2M	
				M12 Connector	Short	PNP	E2B-M12KS04-M1-B1	E2B-M12KS04-M1-B2
						NPN	E2B-M12KS04-M1-C1	E2B-M12KS04-M1-C2
		Long	PNP		E2B-M12LS04-M1-B1	E2B-M12LS04-M1-B2		
			NPN	E2B-M12LS04-M1-C1	E2B-M12LS04-M1-C2			
Unshielded		8 mm	Pre-wired	Short	PNP	E2B-M12KN08-WP-B1 2M	E2B-M12KN08-WP-B2 2M	
					NPN	E2B-M12KN08-WP-C1 2M	E2B-M12KN08-WP-C2 2M	
				Long	PNP	E2B-M12LN08-WP-B1 2M	E2B-M12LN08-WP-B2 2M	
				NPN	E2B-M12LN08-WP-C1 2M	E2B-M12LN08-WP-C2 2M		
	M12 Connector		Short	PNP	E2B-M12KN08-M1-B1	E2B-M12KN08-M1-B2		
				NPN	E2B-M12KN08-M1-C1	E2B-M12KN08-M1-C2		
Long		PNP	E2B-M12LN08-M1-B1	E2B-M12LN08-M1-B2				
	NPN	E2B-M12LN08-M1-C1	E2B-M12LN08-M1-C2					

Note: 1. Pre-wired Models are available in the cable lengths of 2 m and 5 m.

2. There are restrictions that apply to Shielded sensors.





Please refer to "Effects of Surrounding Metal" on page 20.

Size		Sensing distance	Connecting method (See note 1.)	Body length	Output configuration	Operation mode NO	Operation mode NC
M18 (Brass)	Single	Shielded  5 mm	Pre-wired	Short	PNP	E2B-M18KS05-WP-B1 2M	E2B-M18KS05-WP-B2 2M
					NPN	E2B-M18KS05-WP-C1 2M	E2B-M18KS05-WP-C2 2M
				Long	PNP	E2B-M18LS05-WP-B1 2M	E2B-M18LS05-WP-B2 2M
			NPN		E2B-M18LS05-WP-C1 2M	E2B-M18LS05-WP-C2 2M	
			M12 Connector	Short	PNP	E2B-M18KS05-M1-B1	E2B-M18KS05-M1-B2
					NPN	E2B-M18KS05-M1-C1	E2B-M18KS05-M1-C2
		Long		PNP	E2B-M18LS05-M1-B1	E2B-M18LS05-M1-B2	
			NPN	E2B-M18LS05-M1-C1	E2B-M18LS05-M1-C2		
		Unshielded  10 mm	Pre-wired	Short	PNP	E2B-M18KN10-WP-B1 2M	E2B-M18KN10-WP-B2 2M
					NPN	E2B-M18KN10-WP-C1 2M	E2B-M18KN10-WP-C2 2M
				Long	PNP	E2B-M18LN10-WP-B1 2M	E2B-M18LN10-WP-B2 2M
			NPN		E2B-M18LN10-WP-C1 2M	E2B-M18LN10-WP-C2 2M	
	M12 Connector		Short	PNP	E2B-M18KN10-M1-B1	E2B-M18KN10-M1-B2	
				NPN	E2B-M18KN10-M1-C1	E2B-M18KN10-M1-C2	
		Long	PNP	E2B-M18LN10-M1-B1	E2B-M18LN10-M1-B2		
	NPN		E2B-M18LN10-M1-C1	E2B-M18LN10-M1-C2			
	Double	Shielded (See note 2.)  8 mm	Pre-wired	Short	PNP	E2B-M18KS08-WP-B1 2M	E2B-M18KS08-WP-B2 2M
					NPN	E2B-M18KS08-WP-C1 2M	E2B-M18KS08-WP-C2 2M
				Long	PNP	E2B-M18LS08-WP-B1 2M	E2B-M18LS08-WP-B2 2M
			NPN		E2B-M18LS08-WP-C1 2M	E2B-M18LS08-WP-C2 2M	
			M12 Connector	Short	PNP	E2B-M18KS08-M1-B1	E2B-M18KS08-M1-B2
					NPN	E2B-M18KS08-M1-C1	E2B-M18KS08-M1-C2
		Long		PNP	E2B-M18LS08-M1-B1	E2B-M18LS08-M1-B2	
			NPN	E2B-M18LS08-M1-C1	E2B-M18LS08-M1-C2		
Unshielded  16 mm		Pre-wired	Short	PNP	E2B-M18KN16-WP-B1 2M	E2B-M18KN16-WP-B2 2M	
				NPN	E2B-M18KN16-WP-C1 2M	E2B-M18KN16-WP-C2 2M	
			Long	PNP	E2B-M18LN16-WP-B1 2M	E2B-M18LN16-WP-B2 2M	
		NPN		E2B-M18LN16-WP-C1 2M	E2B-M18LN16-WP-C2 2M		
	M12 Connector	Short	PNP	E2B-M18KN16-M1-B1	E2B-M18KN16-M1-B2		
			NPN	E2B-M18KN16-M1-C1	E2B-M18KN16-M1-C2		
Long		PNP	E2B-M18LN16-M1-B1	E2B-M18LN16-M1-B2			
	NPN	E2B-M18LN16-M1-C1	E2B-M18LN16-M1-C2				

Note: 1. Pre-wired Models are available in the cable lengths of 2 m and 5 m.

2. There are restrictions that apply to Shielded sensors.

Please refer to "Effects of Surrounding Metal" on page 20.

Size		Sensing distance	Connecting method (See note 1.)	Body length	Output configuration	Operation mode NO	Operation mode NC
M30 (Brass)	Single	Shielded  10 mm	Pre-wired	Short	PNP	E2B-M30KS10-WP-B1 2M	E2B-M30KS10-WP-B2 2M
					NPN	E2B-M30KS10-WP-C1 2M	E2B-M30KS10-WP-C2 2M
				Long	PNP	E2B-M30LS10-WP-B1 2M	E2B-M30LS10-WP-B2 2M
			NPN		E2B-M30LS10-WP-C1 2M	E2B-M30LS10-WP-C2 2M	
			M12 Connector	Short	PNP	E2B-M30KS10-M1-B1	E2B-M30KS10-M1-B2
					NPN	E2B-M30KS10-M1-C1	E2B-M30KS10-M1-C2
		Long		PNP	E2B-M30LS10-M1-B1	E2B-M30LS10-M1-B2	
			NPN	E2B-M30LS10-M1-C1	E2B-M30LS10-M1-C2		
		Unshielded  20 mm	Pre-wired	Short	PNP	E2B-M30KN20-WP-B1 2M	E2B-M30KN20-WP-B2 2M
					NPN	E2B-M30KN20-WP-C1 2M	E2B-M30KN20-WP-C2 2M
				Long	PNP	E2B-M30LN20-WP-B1 2M	E2B-M30LN20-WP-B2 2M
			NPN		E2B-M30LN20-WP-C1 2M	E2B-M30LN20-WP-C2 2M	
	M12 Connector		Short	PNP	E2B-M30KN20-M1-B1	E2B-M30KN20-M1-B2	
				NPN	E2B-M30KN20-M1-C1	E2B-M30KN20-M1-C2	
		Long	PNP	E2B-M30LN20-M1-B1	E2B-M30LN20-M1-B2		
	NPN		E2B-M30LN20-M1-C1	E2B-M30LN20-M1-C2			
	Double	Shielded (See note 2.)  15 mm	Pre-wired	Short	PNP	E2B-M30KS15-WP-B1 2M	E2B-M30KS15-WP-B2 2M
					NPN	E2B-M30KS15-WP-C1 2M	E2B-M30KS15-WP-C2 2M
				Long	PNP	E2B-M30LS15-WP-B1 2M	E2B-M30LS15-WP-B2 2M
			NPN		E2B-M30LS15-WP-C1 2M	E2B-M30LS15-WP-C2 2M	
			M12 Connector	Short	PNP	E2B-M30KS15-M1-B1	E2B-M30KS15-M1-B2
					NPN	E2B-M30KS15-M1-C1	E2B-M30KS15-M1-C2
		Long		PNP	E2B-M30LS15-M1-B1	E2B-M30LS15-M1-B2	
			NPN	E2B-M30LS15-M1-C1	E2B-M30LS15-M1-C2		
Unshielded  30 mm		Pre-wired	Long	PNP	E2B-M30LN30-WP-B1 2M	E2B-M30LN30-WP-B2 2M	
				NPN	E2B-M30LN30-WP-C1 2M	E2B-M30LN30-WP-C2 2M	
			M12 Connector	Long	PNP	E2B-M30LN30-M1-B1	E2B-M30LN30-M1-B2
		NPN			E2B-M30LN30-M1-C1	E2B-M30LN30-M1-C2	

Note: 1. Pre-wired Models are available in the cable lengths of 2 m and 5 m.

2. There are restrictions that apply to Shielded sensors.

Please refer to "Effects of Surrounding Metal" on page 20.

Accessories (Order Separately)

Sensor I/O Connectors

Size	Cable	Shape	Cores	Cable length (m)	Model
M8 (3-pin)	PVC	Straight	3	2	XS3F-M8PVC3S2M
				5	XS3F-M8PVC3S5M
		Right-angle		2	XS3F-M8PVC3A2M
				5	XS3F-M8PVC3A5M
	PVC Robot	Straight		2	XS3F-M321-302-R
				5	XS3F-M321-305-R
		Right-angle		2	XS3F-M322-302-R
				5	XS3F-M322-305-R
M12 (4-pin)	PVC	Straight	4	2	XS2F-M12PVC4S2M
				5	XS2F-M12PVC4S5M
		Right-angle		2	XS2F-M12PVC4A2M
				5	XS2F-M12PVC4A5M
	PVC Robot	Straight		2	XS2F-D421-D80-F
				5	XS2F-D421-G80-F
		Right-angle		2	XS2F-D422-D80-F
				5	XS2F-D422-G80-F

Model Number Legend

E2B-□□□□□□-□-□□□□
 1 2 3 4 5 6 7 8 9 10

Example: E2B-M12LS04-M1-B1

E2B-S08KN02-WP-C2 5M

M12, Brass, Long body, Shielded, Sn = 4 mm, M12 connector, PNP, NO

M8, stainless steel, Short body, Unshielded, Sn = 2 mm, Pre-wired PVC cable, NPN, NC,
 Cable length = 5 m

1. Basic name

E2B

2. Housing shape and material

M: Cylindrical, metric threaded, brass

S: Cylindrical, metric threaded, stainless steel

3. Housing size

08: 8 mm

12: 12 mm

18: 18 mm

30: 30 mm

4. Barrel length

K: Short body

L: Long body

5. Shield

S: Shielded

N: Unshielded

6. Sensing distance

Numeral: Sensing distance:

01 = 1.5 mm, 02 = 2 mm, 04 = 4 mm, 05 = 5 mm,
 08 = 8 mm, 10 = 10 mm, 15 = 15 mm, 16 = 16 mm,
 20 = 20 mm, 30 = 30 mm

7. Kind of connection

WZ: Pre-wired, PVC, dia 4 mm

Conductor cross section : 0.3 mm²

Insulator diameter : 1.3 mm

(See note 1.)

WP: Pre-wired, PVC, dia 4 mm

Conductor cross section : 0.141 mm²

Insulator diameter : 0.85 mm

M1: M12 connector

MC: M8 connector (3 pin)

(See note 2.)

8. Power source and output

B: PNP

C: NPN

9. Operation mode

1: NO (Normally open)

2: NC (Normally closed)

10. Cable length

Blank: Connector type

Numeral: Cable length (2M and 5M are available.)

Note: 1. Only M12, M18, M30 type.

2. "WP", "M1" and "MC" are listed products of UL.

E2B

Ratings and Specifications

Item	Size	M8			
	Sensing distance	Single		Double	
	Type	Shielded	Unshielded	Shielded	Unshielded
	Model	E2B-S08□S01	E2B-S08□N02	E2B-S08□S02	E2B-S08□N04
Sensing distance		1.5 mm ± 10%	2 mm ± 10%	2 mm ± 10%	4 mm ± 10%
Setting distance		0 to 1.2 mm	0 to 1.6 mm	0 to 1.6 mm	0 to 3.2 mm
Differential travel		10% max. of sensing distance			
Detectable object		Ferrous metal (The sensing distance decreases with non-ferrous metal.)			
Standard sensing object (mild steel ST37)		8 × 8 × 1 mm	8 × 8 × 1 mm	8 × 8 × 1 mm	12 × 12 × 1 mm
Response frequency (See note 1.)		2,000 Hz	1,000 Hz	1,500 Hz	1,000 Hz
Power supply voltage		10 to 30 VDC. (including 10% ripple (p-p))			
Current consumption		10 mA max.			
Output type		-B models: PNP open collector -C models: NPN open collector			
Control output	Load current (See note 2.)	200 mA max. (30 VDC max.)			
	Residual voltage	2 V max. (under load current of 200 mA with cable length of 2 m)			
Indicator		Operation indicator (Yellow LED)			
Operation mode (with sensing object approaching)		-B1/-C1 models: NO -B2/-C2 models: NC			
Protection circuit		Output reverse polarity protection, Power source circuit reverse polarity protection, Surge suppressor, Short-circuit protection			
Ambient air temperature		Operation and storage : -25 to 70°C (with no icing or condensation)			
Temperature influence (See note 2.)		±10% max. of sensing distance at 23°C within temperature range of -10 to 55°C ±15% max. of sensing distance at 23°C within temperature range of -25 to 70°C			
Ambient humidity		Operation and Storage: 35 to 95%			
Voltage influence		±1% max. of sensing distance in 24 VDC ±15%			
Insulation resistance		50 MΩ min. (at 500 VDC) between current-carrying parts and case			
Dielectric strength		1,000 VAC at 50/60 Hz for 1 min between current-carrying parts and case			
Vibration resistance		10 to 55 Hz, 1.5-mm double amplitude for 2 hours each in X, Y and Z directions			
Shock resistance		500 m/s ² , 10 times each in X, Y and Z directions			
Standard and listings		(1) IP67 (IEC60529) (2) EMC (EN60947-5-2)			
Connecting method		Pre-wired models (standard is 4 mm dia. PVC cable with length = 2 m, 5 m). Connector models (M8-3pin)			
Weight (packaged)	Pre-wired model	Short body: Approx. 65 g, Long body: Approx. 65 g			
	Connector model	Short body: Approx. 20 g, Long body: Approx. 20 g			
Material	Case	Stainless steel (1.4305 (W.-No.), SUS 303 (AISI), 2346 (SS).)			
	Sensing surface	PBT			
	Cable	Standard cable is 4 mm dia. PVC.			
	Clamping nut	Brass-nickel plated			
	Toothed washer	Zinc-plated iron			

Note: 1. The response frequency is an average value. Measurement conditions are as follows: standard sensing object, a distance of twice the standard sensing object between sensing objects, and a setting distance of half the sensing distance.

2. When using any model of M8 size at an ambient temperature between -25°C and 60°C, use a load current of 200mA max., at an ambient temperature between 60°C and 70°C, use a load current of 100 mA max.

Item	Size	M12			
	Sensing distance	Single		Double	
	Type	Shielded	Unshielded	Shielded	Unshielded
	Model	E2B-M12□S02	E2B-M12□N05	E2B-M12□S04	E2B-M12□N08
Sensing distance	2 mm ± 10%	5 mm ± 10%	4 mm ± 10%	8 mm ± 10%	
Setting distance	0 to 1.6 mm	0 to 4 mm	0 to 3.2 mm	0 to 6.4 mm	
Differential travel	10% max. of sensing distance				
Detectable object	Ferrous metal (The sensing distance decreases with non-ferrous metal.)				
Standard sensing object (mild steel ST37)	12 × 12 × 1 mm	15 × 15 × 1 mm	12 × 12 × 1 mm	24 × 24 × 1 mm	
Response frequency (See note 1.)	1,500 Hz	800 Hz	1,000 Hz	800 Hz	
Power supply voltage	10 to 30 VDC. (including 10% ripple (p-p))				
Current consumption	10 mA max.				
Output type	-B models: PNP open collector -C models: NPN open collector				
Control output	Load current	200 mA max. (30 VDC max.)			
	Residual voltage	2 V max. (under load current of 200 mA with cable length of 2 m)			
Indicator	Operation indicator (Yellow LED)				
Operation mode (with sensing object approaching)	-B1/-C1 models: NO -B2/-C2 models: NC				
Protection circuit	Output reverse polarity protection, Power source circuit reverse polarity protection, Surge suppressor, Short-circuit protection				
Ambient air temperature	Operation and storage : -25 to 70°C (with no icing or condensation)				
Temperature influence	±10% max. of sensing distance at 23°C within temperature range of -10 to 55°C ±15% max. of sensing distance at 23°C within temperature range of -25 to 70°C				
Ambient humidity	Operation and Storage: 35 to 95%				
Voltage influence	±1% max. of sensing distance in 24 VDC ±15%				
Insulation resistance	50 MΩ min. (at 500 VDC) between current-carrying parts and case				
Dielectric strength	1,000 VAC at 50/60 Hz for 1 min between current-carrying parts and case				
Vibration resistance	10 to 55 Hz, 1.5-mm double amplitude for 2 hours each in X, Y and Z directions				
Shock resistance	1,000 m/s ² , 10 times each in X, Y and Z directions				
Standard and listings	(1) IP67 (IEC60529) (2) EMC (EN60947-5-2)				
Connecting method	Pre-wired models (standard is 4 mm dia. PVC cable with length = 2 m, 5 m). Connector models (M12-4pin)				
Weight (packaged)	Pre-wired model	Short body: Approx. 75 g, Long body: Approx. 80 g (See note 2.)			
	Connector model	Short body: Approx. 35 g, Long body: Approx. 40 g			
Material	Case	Brass-nickel plated			
	Sensing surface	PBT			
	Cable	Standard cable is 4 mm dia. PVC.			
	Clamping nut	Brass-nickel plated			
	Toothed washer	Zinc-plated iron			

Note: 1. The response frequency is an average value. Measurement conditions are as follows: standard sensing object, a distance of twice the standard sensing object between sensing objects, and a setting distance of half the sensing distance.

2. In case of 'WP' cable type.

Item	Size	M18			
	Sensing distance	Single		Double	
	Type	Shielded	Unshielded	Shielded	Unshielded
	Model	E2B-M18□S05	E2B-M18□N10	E2B-M18□S08	E2B-M18□N16
Sensing distance		5 mm ± 10%	10 mm ± 10%	8 mm ± 10%	16 mm ± 10%
Setting distance		0 to 4 mm	0 to 8 mm	0 to 6.4 mm	0 to 12.8 mm
Differential travel		10% max. of sensing distance			
Detectable object		Ferrous metal (The sensing distance decreases with non-ferrous metal.)			
Standard sensing object (mild steel ST37)		18 × 18 × 1 mm	30 × 30 × 1 mm	24 × 24 × 1 mm	48 × 48 × 1 mm
Response frequency (See note 1.)		600 Hz	400 Hz	500 Hz	400 Hz
Power supply voltage		10 to 30 VDC. (including 10% ripple (p-p))			
Current consumption		10 mA max.			
Output type		-B models: PNP open collector -C models: NPN open collector			
Control output	Load current	200 mA max. (30 VDC max.)			
	Residual voltage	2 V max. (under load current of 200 mA with cable length of 2 m)			
Indicator		Operation indicator (Yellow LED)			
Operation mode (with sensing object approaching)		-B1/-C1 models: NO -B2/-C2 models: NC			
Protection circuit		Output reverse polarity protection, Power source circuit reverse polarity protection, Surge suppressor, Short-circuit protection			
Ambient air temperature		Operation and storage : -25 to 70°C (with no icing or condensation)			
Temperature influence		±10% max. of sensing distance at 23°C within temperature range of -10 to 55°C ±15% max. of sensing distance at 23°C within temperature range of -25 to 70°C			
Ambient humidity		Operation and Storage: 35 to 95%			
Voltage influence		±1% max. of sensing distance in 24 VDC ±15%			
Insulation resistance		50 MΩ min. (at 500 VDC) between current-carrying parts and case			
Dielectric strength		1,000 VAC at 50/60 Hz for 1 min between current-carrying parts and case			
Vibration resistance		10 to 55 Hz, 1.5-mm double amplitude for 2 hours each in X, Y and Z directions			
Shock resistance		1,000 m/s ² , 10 times each in X, Y and Z directions			
Standard and listings		(1) IP67 (IEC60529) (2) EMC (EN60947-5-2)			
Connecting method		Pre-wired models (standard is 4 mm dia. PVC cable with length = 2 m, 5 m). Connector models (M12-4pin)			
Weight (packaged)	Pre-wired model	Short body: Approx. 95 g, Long body: Approx. 110 g (See note 2.)			
	Connector model	Short body: Approx. 60 g, Long body: Approx. 80 g			
Material	Case	Brass-nickel plated			
	Sensing surface	PBT			
	Cable	Standard cable is 4 mm dia. PVC.			
	Clamping nut	Brass-nickel plated			
	Toothed washer	Zinc-plated iron			

Note: 1. The response frequency is an average value. Measurement conditions are as follows: standard sensing object, a distance of twice the standard sensing object between sensing objects, and a setting distance of half the sensing distance.
2. In case of 'WP' cable type.

Item	Size	M30						
	Sensing distance	Single		Double				
	Type	Shielded	Unshielded	Shielded	Unshielded			
	Model	E2B-M30□S10	E2B-M30□N20	E2B-M30□S15	E2B-M30□N30			
Sensing distance	10 mm ± 10%		20 mm ± 10%		15 mm ± 10%		30 mm ± 10%	
Setting distance	0 to 8 mm		0 to 16 mm		0 to 11.25 mm		0 to 22.5 mm	
Differential travel	10% max. of sensing distance							
Detectable object	Ferrous metal (The sensing distance decreases with non-ferrous metal.)							
Standard sensing object (mild steel ST37)	30 × 30 × 1 mm		60 × 60 × 1 mm		45 × 45 × 1 mm		90 × 90 × 1 mm	
Response frequency (See note 1.)	400 Hz		100 Hz		250 Hz		100 Hz	
Power supply voltage	10 to 30 VDC. (including 10% ripple (p-p))							
Current consumption	10 mA max.							
Output type	-B models: PNP open collector -C models: NPN open collector							
Control output	Load current	200 mA max. (30 VDC max.)						
	Residual voltage	2 V max. (under load current of 200 mA with cable length of 2 m)						
Indicator	Operation indicator (Yellow LED)							
Operation mode (with sensing object approaching)	-B1/-C1 models: NO -B2/-C2 models: NC							
Protection circuit	Output reverse polarity protection, Power source circuit reverse polarity protection, Surge suppressor, Short-circuit protection							
Ambient air temperature	Operation and storage : -25 to 70°C (with no icing or condensation)							
Temperature influence	±10% max. of sensing distance at 23°C within temperature range of -10 to 55°C ±15% max. of sensing distance at 23°C within temperature range of -25 to 70°C							
Ambient humidity	Operation and Storage: 35 to 95%							
Voltage influence	±1% max. of sensing distance in 24 VDC ±15%							
Insulation resistance	50 MΩ min. (at 500 VDC) between current-carrying parts and case							
Dielectric strength	1,000 VAC at 50/60 Hz for 1 min between current-carrying parts and case							
Vibration resistance	10 to 55 Hz, 1.5-mm double amplitude for 2 hours each in X, Y and Z directions							
Shock resistance	1,000 m/s ² , 10 times each in X, Y and Z directions							
Standard and listings	(1) IP67 (IEC60529) (2) EMC (EN60947-5-2)							
Connecting method	Pre-wired models (standard is 4 mm dia. PVC cable with length = 2 m, 5 m). Connector models (M12-4pin)							
Weight (packaged)	Pre-wired model	Short body: Approx. 160 g, Long body: Approx. 210 g (See note 2.)						
	Connector model	Short body: Approx. 140 g, Long body: Approx. 160 g						
Material	Case	Brass-nickel plated						
	Sensing surface	PBT						
	Cable	Standard cable is 4 mm dia. PVC.						
	Clamping nut	Brass-nickel plated						
	Toothed washer	Zinc-plated iron						

Note: 1. The response frequency is an average value. Measurement conditions are as follows: standard sensing object, a distance of twice the standard sensing object between sensing objects, and a setting distance of half the sensing distance.

2. In case of 'WP' cable type.

E2B

Engineering Data (Reference Value)

Operating Range M8

E2B-S08

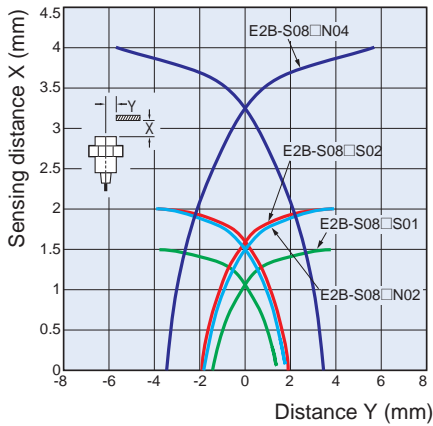

Influence of Sensing Object Size and Materials Shielded Models

E2B-S08□S01

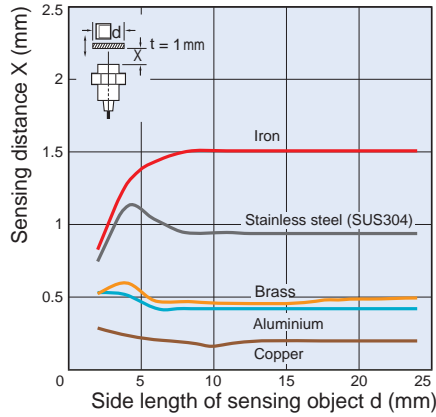

Unshielded Models

E2B-S08□N02

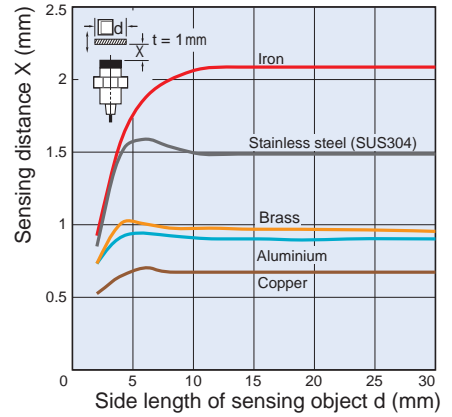

E2B-S08□S02

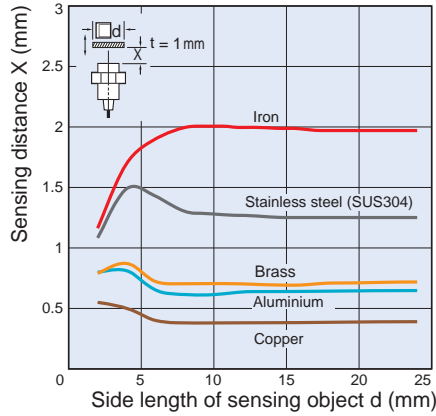

E2B-S08□N04

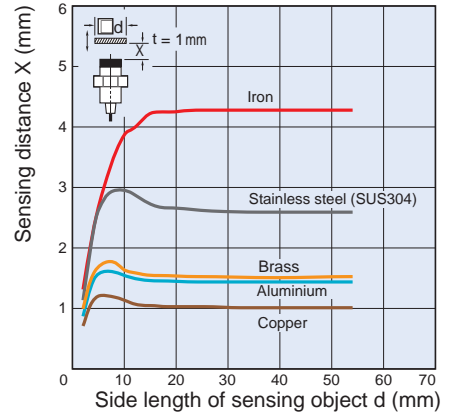

Operating Range M12

E2B-M12

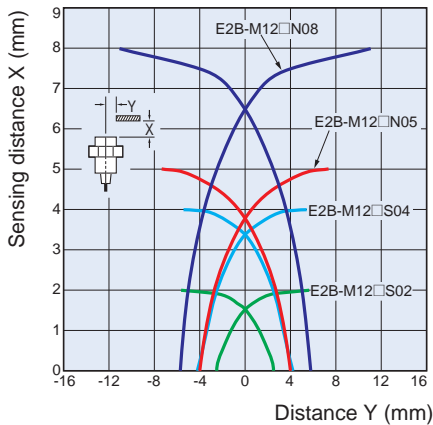

Influence of Sensing Object Size and Materials Shielded Models

E2B-M12□S02

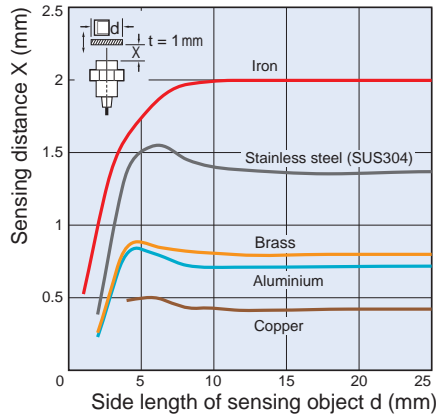

Unshielded Models

E2B-M12□N05

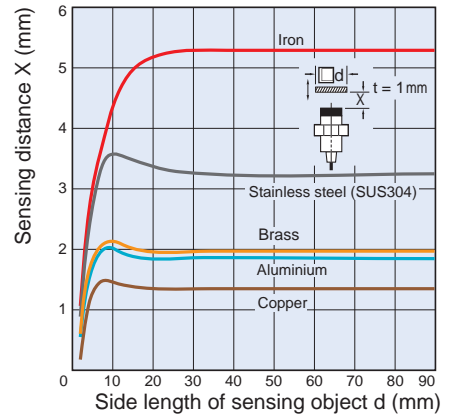

E2B-M12□S04

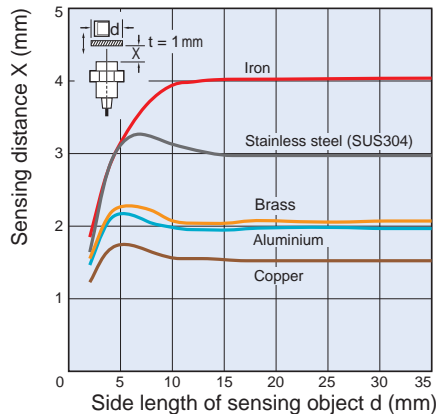

E2B-M12□N08

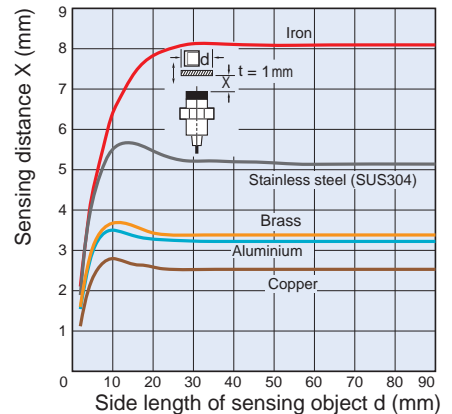

Operating Range

M18

E2B-M18

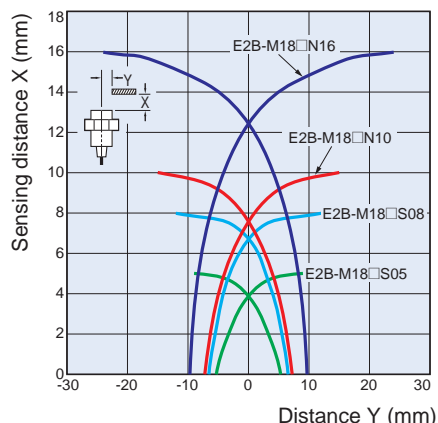

Influence of Sensing Object Size and Materials

Shielded Models

E2B-M18□S05

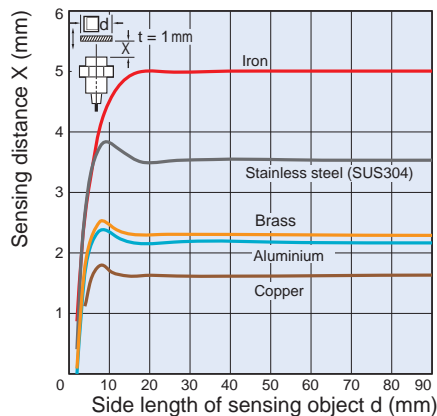

Unshielded Models

E2B-M18□N10

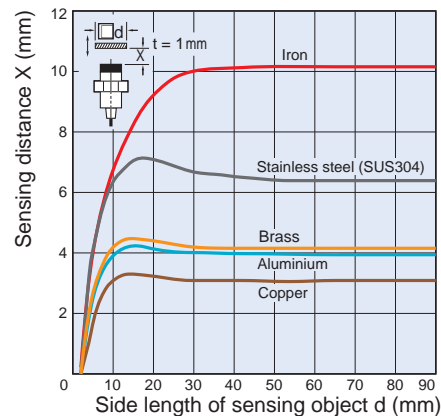

E2B-M18□S08

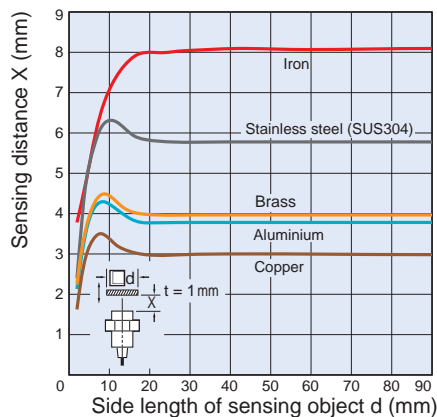

E2B-M18□N16

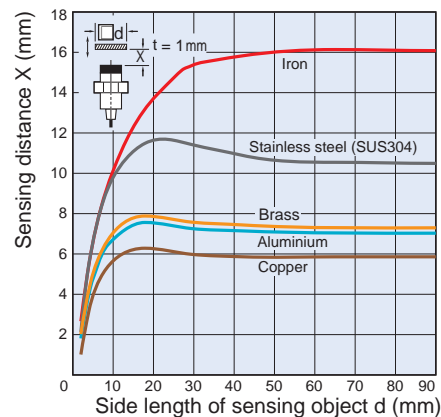

Operating Range

M30

E2B-M30

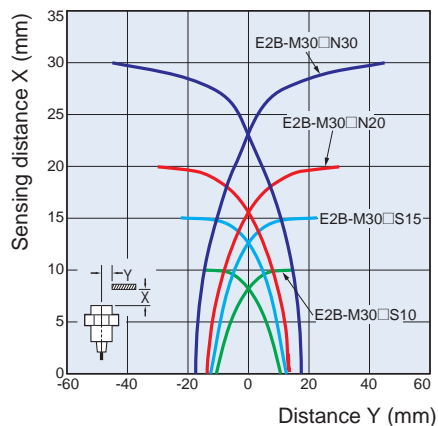

Influence of Sensing Object Size and Materials

Shielded Models

E2B-M30□S10

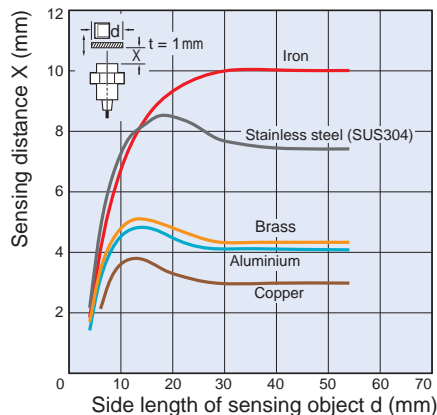

Unshielded Models

E2B-M30□N20

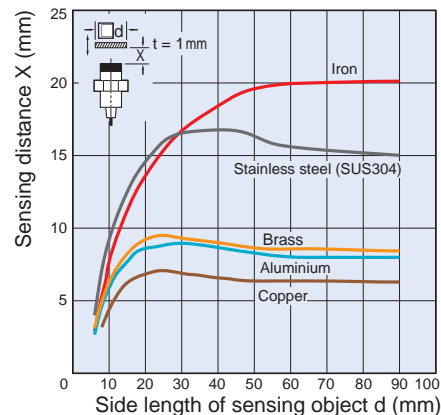

E2B-M30□S15

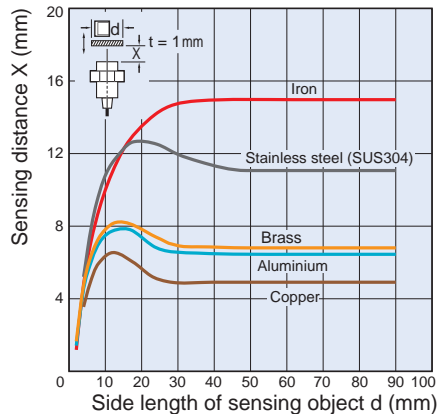

E2B-M30□N30

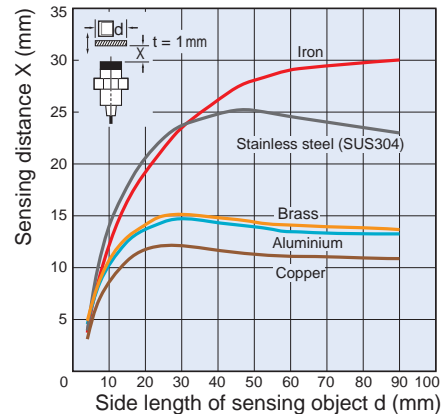

E2B

I/O Circuit Diagrams

PNP Output

Operation mode	Model	Timing chart	Output circuit
NO	E2B-S08□-□-B□	<p>Non-sensing zone Sensing zone Proximity Sensor</p> <p>Sensing object</p> <p>(%) 100 0</p> <p>Rated sensing distance</p> <p>ON OFF Yellow indicator</p> <p>ON OFF Control output</p>	<p>main circuits</p> <p>Brown ①</p> <p>Black ④</p> <p>Blue ③</p> <p>Load</p> <p>10 to 30 VDC</p>
NC		<p>Non-sensing zone Sensing zone Proximity Sensor</p> <p>Sensing object</p> <p>(%) 100 0</p> <p>Rated sensing distance</p> <p>ON OFF Yellow indicator</p> <p>ON OFF Control output</p>	<p>M8 connector (3 pin) Pin Arrangement</p> <p>④</p> <p>① ③</p>
NO	E2B-M12□-□-B□ E2B-M18□-□-B□ E2B-M30□-□-B□	<p>Non-sensing zone Sensing zone Proximity Sensor</p> <p>Sensing object</p> <p>(%) 100 0</p> <p>Rated sensing distance</p> <p>ON OFF Yellow indicator</p> <p>ON OFF Control output</p>	<p>main circuits</p> <p>Brown ①</p> <p>Black ④ or ②</p> <p>Blue ③</p> <p>Load</p> <p>10 to 30 VDC</p> <p>④ : NO ② : NC</p>
NC		<p>Non-sensing zone Sensing zone Proximity Sensor</p> <p>Sensing object</p> <p>(%) 100 0</p> <p>Rated sensing distance</p> <p>ON OFF Yellow indicator</p> <p>ON OFF Control output</p>	<p>M12 Connector (4 pin) Pin Arrangement</p> <p>①</p> <p>② ④</p> <p>③</p>

NPN Output

Operation mode	Model	Timing chart	Output circuit
NO	E2B-S08□-□-□-□-□	<p>Non-sensing zone Sensing zone Proximity Sensor</p> <p>Sensing object</p> <p>(%) 100 0</p> <p>Rated sensing distance</p> <p>ON OFF Yellow indicator</p> <p>ON OFF Control output</p>	<p>main circuits</p> <p>Brown ①</p> <p>Load</p> <p>Black ④</p> <p>Blue ③</p> <p>10 to 30 VDC</p>
NC	E2B-S08□-□-□-□-□	<p>Non-sensing zone Sensing zone Proximity Sensor</p> <p>Sensing object</p> <p>(%) 100 0</p> <p>Rated sensing distance</p> <p>ON OFF Yellow indicator</p> <p>ON OFF Control output</p>	<p>M8 connector (3 pin) Pin Arrangement</p>
NO	E2B-M12□-□-□-□-□ E2B-M18□-□-□-□-□ E2B-M30□-□-□-□-□	<p>Non-sensing zone Sensing zone Proximity Sensor</p> <p>Sensing object</p> <p>(%) 100 0</p> <p>Rated sensing distance</p> <p>ON OFF Yellow indicator</p> <p>ON OFF Control output</p>	<p>main circuits</p> <p>Brown ①</p> <p>Load</p> <p>Black ④ or ②</p> <p>Blue ③</p> <p>10 to 30 VDC</p> <p>④: NO ②: NC</p>
NC	E2B-M12□-□-□-□-□ E2B-M18□-□-□-□-□ E2B-M30□-□-□-□-□	<p>Non-sensing zone Sensing zone Proximity Sensor</p> <p>Sensing object</p> <p>(%) 100 0</p> <p>Rated sensing distance</p> <p>ON OFF Yellow indicator</p> <p>ON OFF Control output</p>	<p>M12 Connector (4 pin) Pin Arrangement</p>

E2B

Dimensions

Note: All units are in millimeters unless otherwise indicated.

M8 Size

Pre-wired Models (Shielded)

Short Body

E2B-S08KS01-WP-□□/E2B-S08KS02-WP-□□

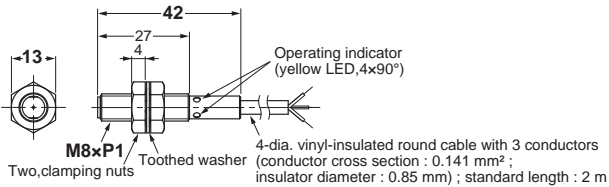

Pre-wired Models (Unshielded)

E2B-S08KN02-WP-□□/E2B-S08KN04-WP-□□

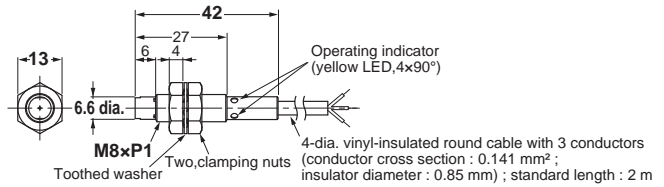

Long Body

E2B-S08LS01-WP-□□/E2B-S08LS02-WP-□□

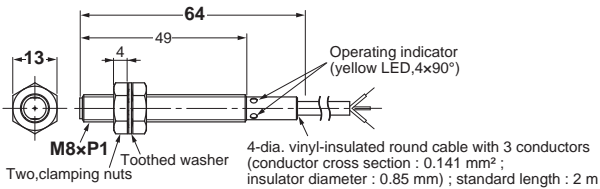

E2B-S08LN02-WP-□□/E2B-S08LN04-WP-□□

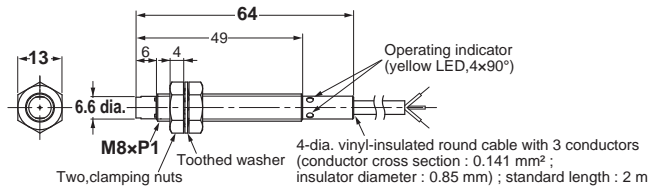

Connector Models (Shielded)

Short Body

E2B-S08KS01-MC-□□/E2B-S08KS02-MC-□□

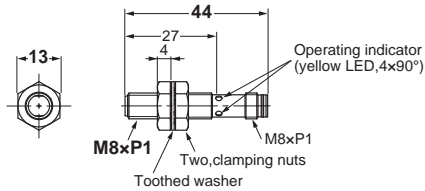

Connector Models (Unshielded)

E2B-S08KN02-MC-□□/E2B-S08KN04-MC-□□

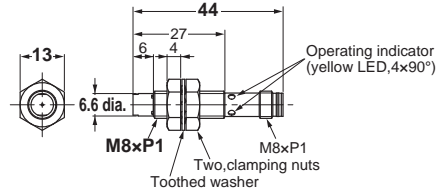

Long Body

E2B-S08LS01-MC-□□/E2B-S08LS02-MC-□□

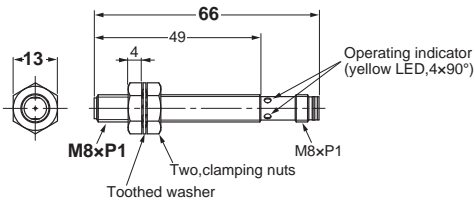

E2B-S08LN02-MC-□□/E2B-S08LN04-MC-□□

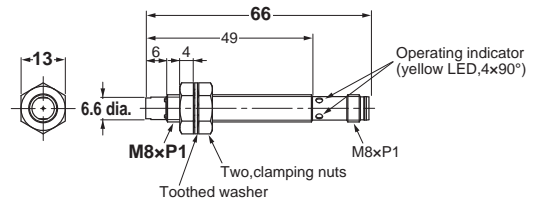

Mounting Hole Cutout Dimensions

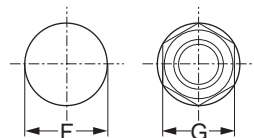

External diameter of Proximity Sensor	Dimension F (mm)	Dimension G (mm)
M8	8.5 dia. ^{+0.5} ₀	13

M12 Size

Pre-wired Models (Shielded)

Short Body

E2B-M12KS02-WP-□□/E2B-M12KS04-WP-□□

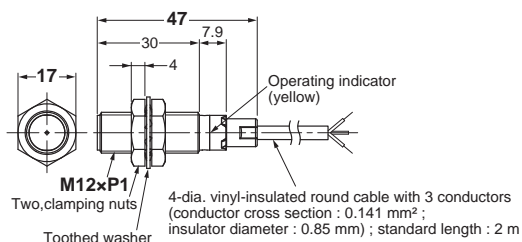

Pre-wired Models (Unshielded)

E2B-M12KN05-WP-□□/E2B-M12KN08-WP-□□

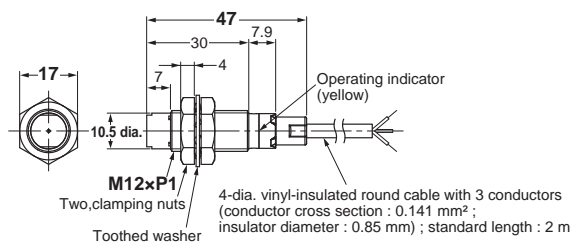

Long Body

E2B-M12LS02-WP-□□/E2B-M12LS04-WP-□□

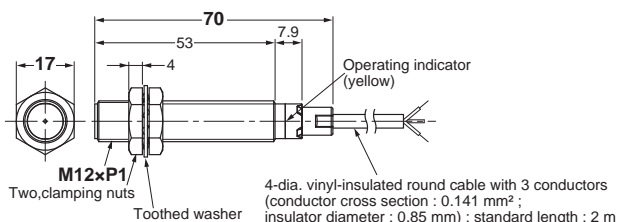

E2B-M12LN05-WP-□□/E2B-M12LN08-WP-□□

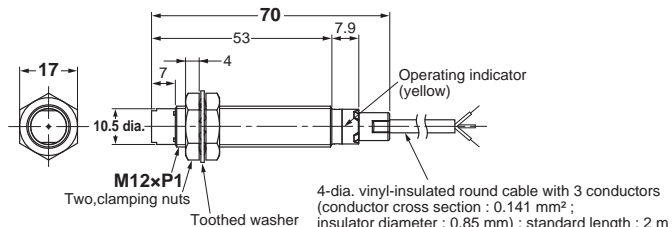

Connector Models (Shielded)

Short Body

E2B-M12KS02-M1-□□/E2B-M12KS04-M1-□□

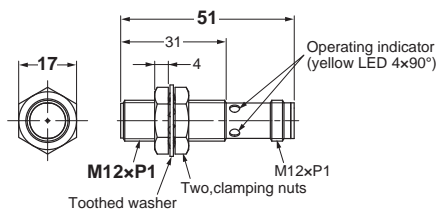

Connector Models (Unshielded)

E2B-M12KN05-M1-□□/E2B-M12KN08-M1-□□

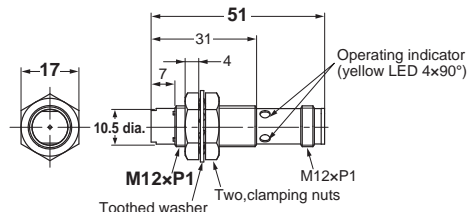

Long Body

E2B-M12LS02-M1-□□/E2B-M12LS04-M1-□□

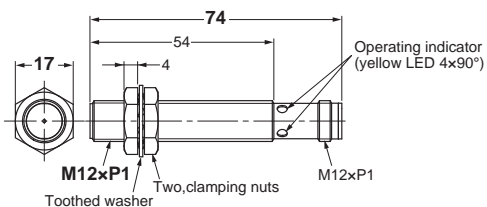

E2B-M12LN05-M1-□□/E2B-M12LN08-M1-□□

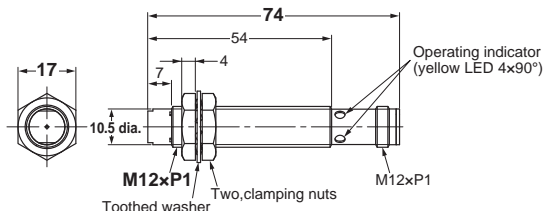

Mounting Hole Cutout Dimensions

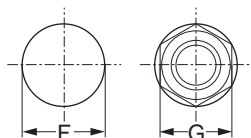

External diameter of Proximity Sensor	Dimension F (mm)	Dimension G (mm)
M12	12.5 dia. ^{+0.5} ₀	17

E2B

M18 Size

Pre-wired Models (Shielded)

Short Body

E2B-M18KS05-WP-□□/E2B-M18KS08-WP-□□

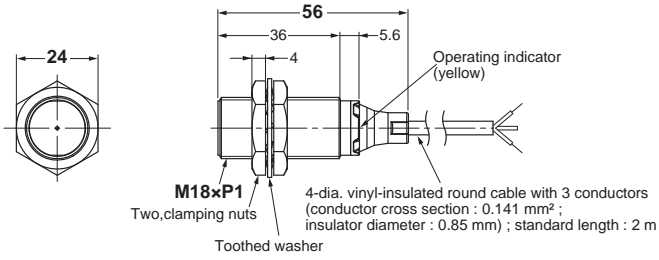

Pre-wired Models (Unshielded)

E2B-M18KN10-WP-□□/E2B-M18KN16-WP-□□

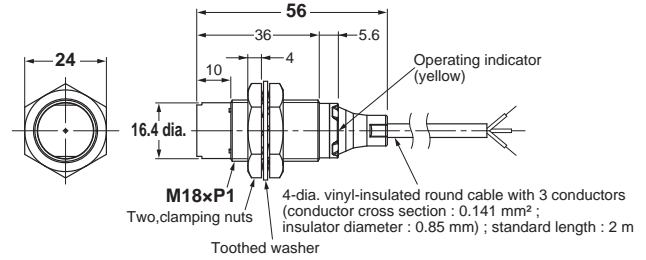

Long Body

E2B-M18LS05-WP-□□/E2B-M18LS08-WP-□□

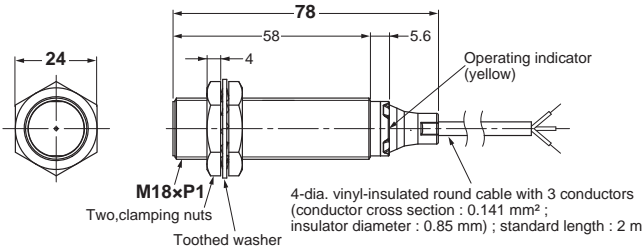

E2B-M18LN10-WP-□□/E2B-M18LN16-WP-□□

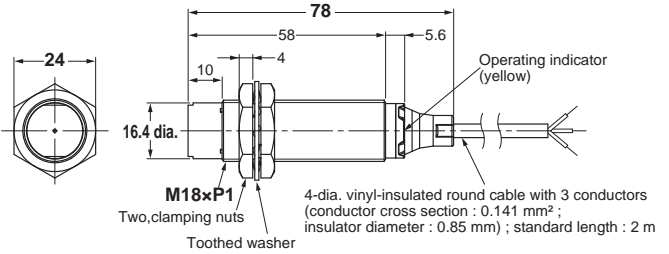

Connector Models (Shielded)

Short Body

E2B-M18KS05-M1-□□/E2B-M18KS08-M1-□□

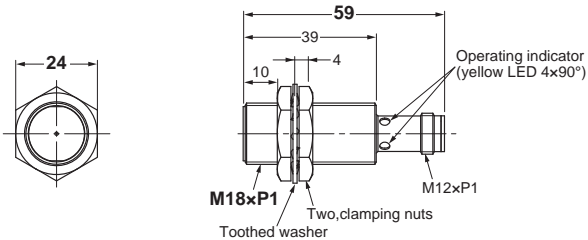

E2B-M18KN10-M1-□□/E2B-M18KN16-M1-□□

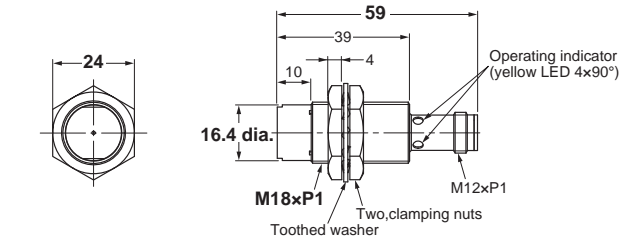

Long Body

E2B-M18LS05-M1-□□/E2B-M18LS08-M1-□□

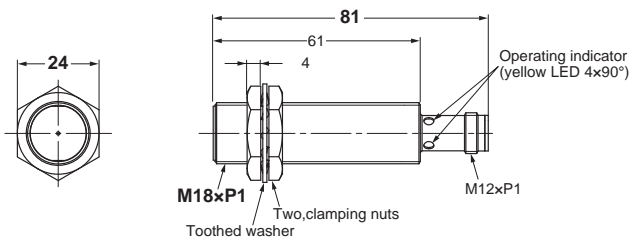

E2B-M18LN10-M1-□□/E2B-M18LN16-M1-□□

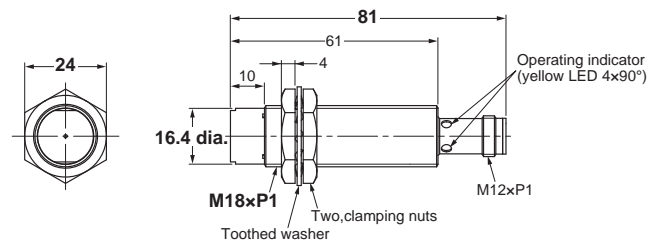

Mounting Hole Cutout Dimensions

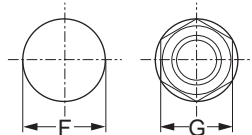

External diameter of Proximity Sensor	Dimension F (mm)	Dimension G (mm)
M18	18.5 dia. ^{+0.5} ₀	24

M30 Size

Pre-wired Models (Shielded)

Short Body

E2B-M30KS10-WP-□□/E2B-M30KS15-WP-□□

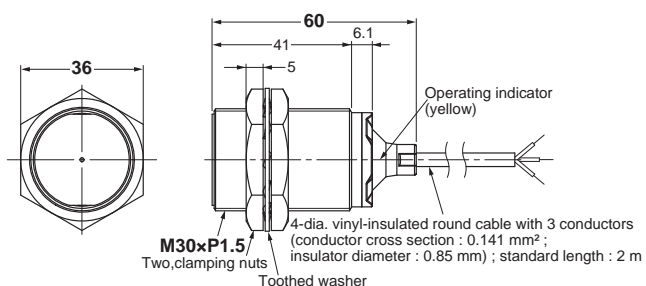

Pre-wired Models (Unshielded)

E2B-M30KN20-WP-□□

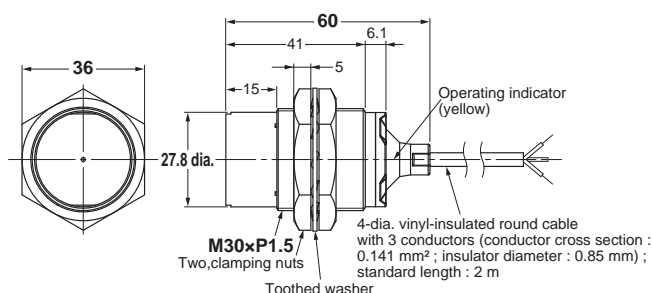

Long Body

E2B-M30LS10-WP-□□/E2B-M30LS15-WP-□□

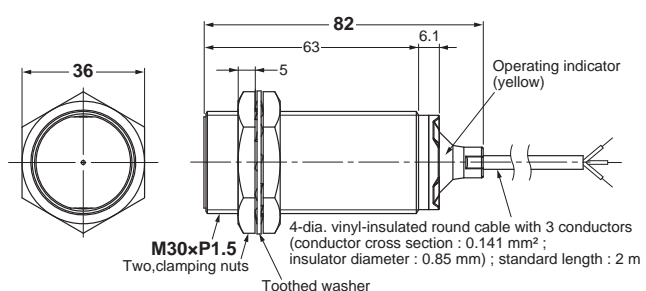

E2B-M30LN20-WP-□□/E2B-M30LN30-WP-□□

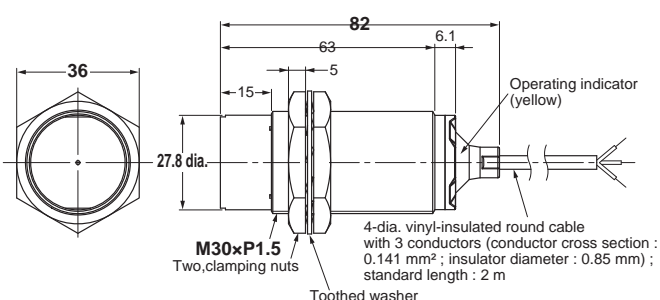

Connector Models (Shielded)

Short Body

E2B-M30KS10-M1-□□/E2B-M30KS15-M1-□□

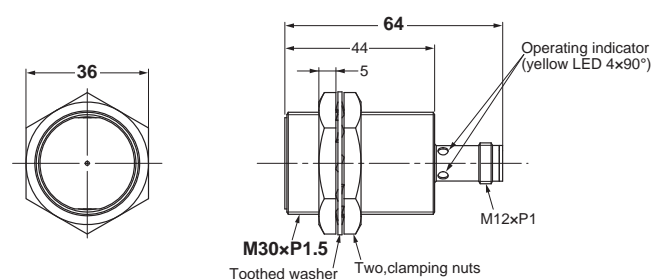

E2B-M30KN20-M1-□□

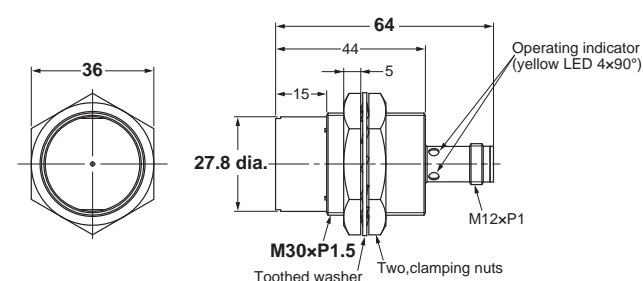

Long Body

E2B-M30LS10-M1-□□/E2B-M30LS15-M1-□□

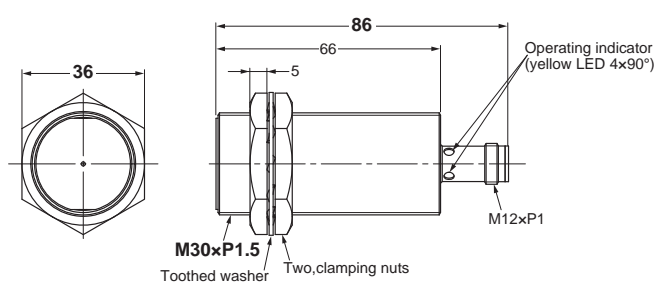

E2B-M30LN20-M1-□□/E2B-M30LN30-M1-□□

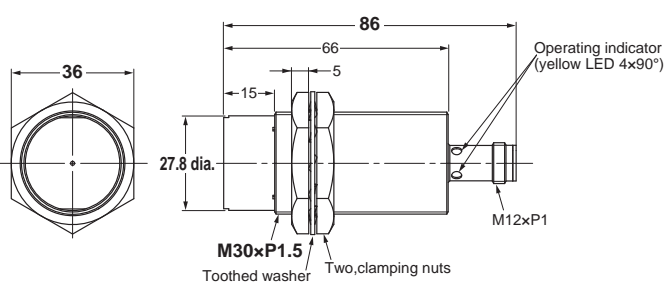

Mounting Hole Cutout Dimensions

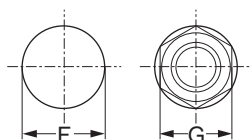

External diameter of Proximity Sensor	Dimension F (mm)	Dimension G (mm)
M30	30.5 dia. ^{+0.5} ₀	36

Accessories (Order Separately)

Sensor I/O Connectors
M8 Connector (3 pin)

PVC Type

(Unit: mm)

Straight

XS3F-M8PVC3S2M (L = 2 m)
XS3F-M8PVC3S5M (L = 5 m)

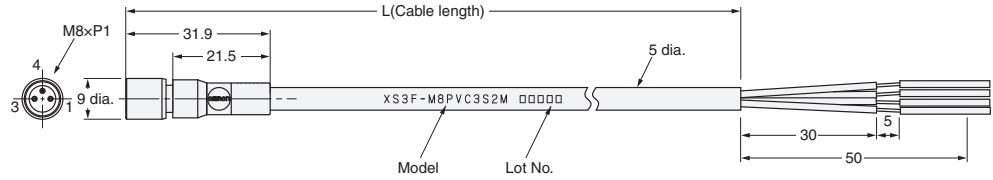

Right-angle

XS3F-M8PVC3A2M (L = 2 m)
XS3F-M8PVC3A5M (L = 5 m)

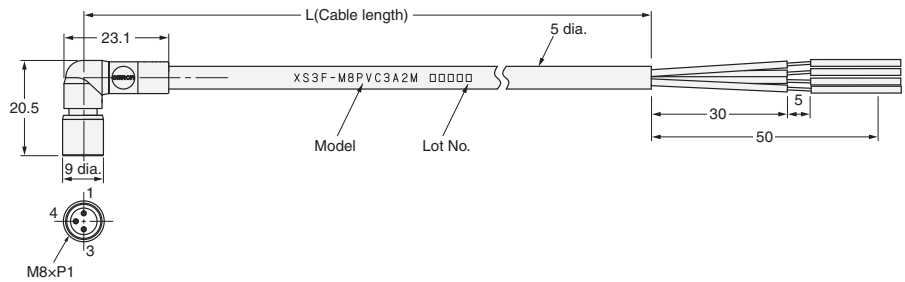

PVC Robot Type

Straight

XS3F-M321-302-R (L = 2 m)
XS3F-M321-305-R (L = 5 m)

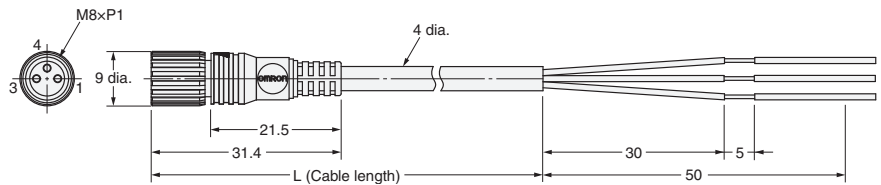

Right-angle

XS3F-M322-302-R (L = 2 m)
XS3F-M322-305-R (L = 5 m)

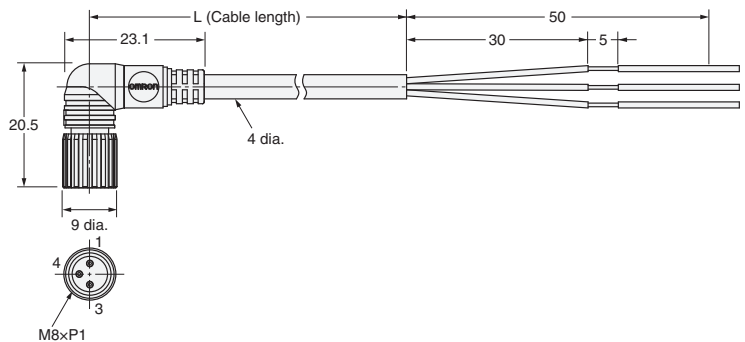

Pin arrangement

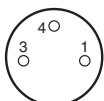

1-Brown
3-Blue
4-Black

Sensor I/O Connectors
M12 Connector (4 pin)

PVC Type

Straight

XS2F-M12PVC4S2M (L = 2 m)
XS2F-M12PVC4S5M (L = 5 m)

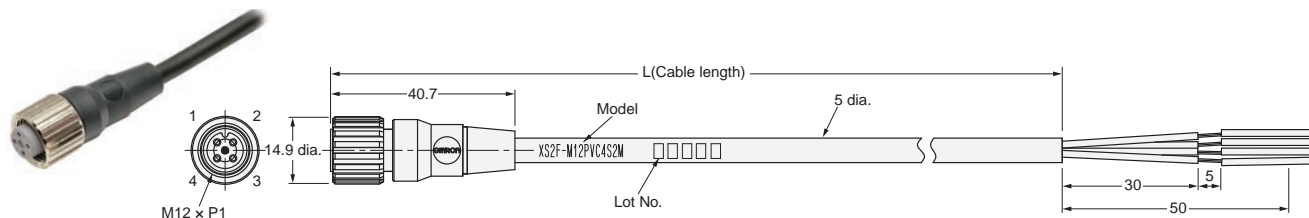

Right-angle

XS2F-M12PVC4A2M (L = 2 m)
XS2F-M12PVC4A5M (L = 5 m)

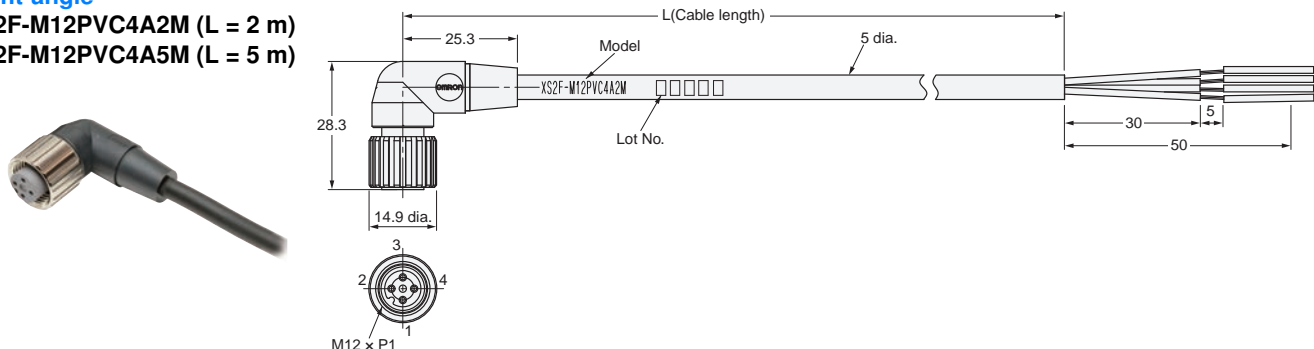

PVC Robot Type

Straight

XS2F-D421-D80-F (L = 2 m)
XS2F-D421-G80-F (L = 5 m)

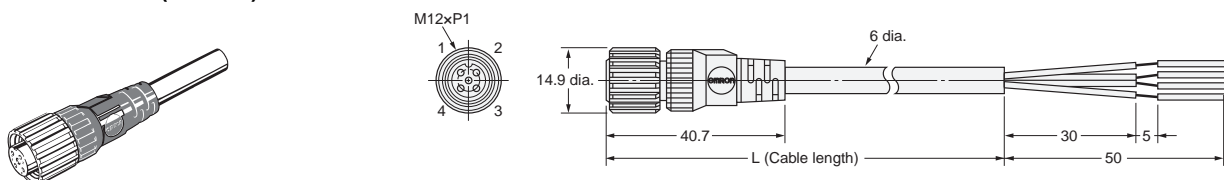

Right-angle

XS2F-D422-D80-F (L = 2 m)
XS2F-D422-G80-F (L = 5 m)

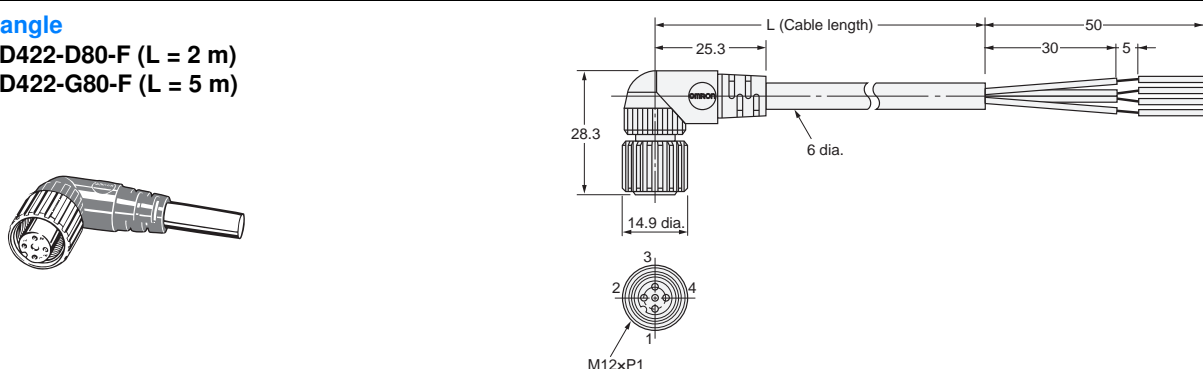

Pin arrangement



- 1-Brown
- 2-White
- 3-Blue
- 4-Black

E2B

Precautions

WARNING

This product is not designed or rated for ensuring safety of persons. Do not use it for such purpose.



Never use this product with an AC power supply. Otherwise, explosion may result.



Safety Precautions

Load Short-circuit

Do not short-circuit the load, or the E2B may be damaged. The E2B's short-circuit protection function will be valid if the polarity of the supply voltage imposed is correct and within the rated voltage range.

Correct Use

Designing

Power Reset Time

The Proximity Sensor is ready to operate within 100 ms after power is supplied. If power supplies are connected to the Proximity Sensor and load respectively, be sure to supply power to the Proximity Sensor before supplying power to the load.

Effects of Surrounding Metal

When mounting the proximity sensor within a metal panel, ensure that the clearances given in the Table1 are maintained. Failure to maintain these distance may cause deterioration in the performance of the sensor.

Table 1
Single Sensing Distance Type
<Shielded>

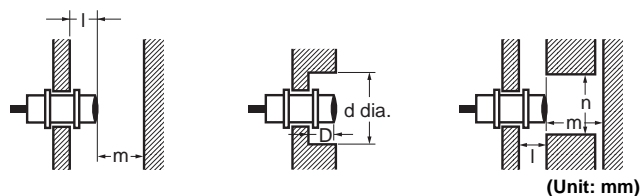

Item	Size	M8	M12	M18	M30
l		0	0	0	0
d		8	12	18	30
D		0	0	0	0
m		4.5	8	20	40
n		12	18	27	45

Double Sensing Distance Type
<Shielded>

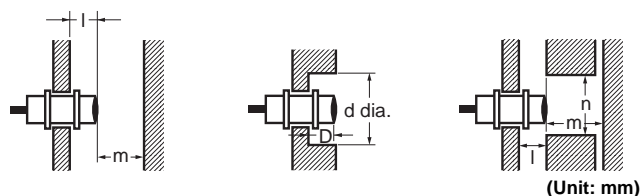

Item	Size	M8	M12	M18	M30
l		0	2.4	3.6	6
d		8	18	27	45
D		0	2.4	3.6	6
m		4.5	12	24	45
n		12	18	27	45

Wiring

Be sure to wire the E2B and load correctly, otherwise it may be damaged.

Connection with No Load

Be sure to insert loads when wiring. Make sure to connect a proper load to the E2B in operation, otherwise it may damage internal elements.

Do not expose the product to flammable or explosive gases.

Do not disassemble, repair, or modify the product.

When provided with the UL Listing Mark, the E2B series with M1 or MC suffix shall be used with a Listed cable/connector assembly rated minimum 30V, minimum 200mA, in the final installation.

<Unshielded>

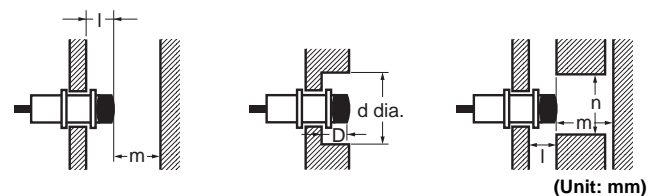

Item	Size	M8	M12	M18	M30
l		6	15	22	30
d		24	40	55	90
D		6	15	22	30
m		8	20	40	70
n		24	36	54	90

<Unshielded>

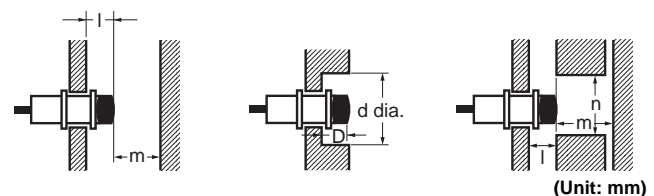

Item	Size	M8	M12	M18	M30
l		12	15	25	45
d		24	40	70	140
D		12	15	25	45
m		8	20	48	90
n		24	40	70	140

Power OFF

The Proximity Sensor may output a pulse signal when it is turned OFF. Therefore, it is recommended that the load be turned OFF before turning OFF the Proximity Sensor.

Power Supply Transformer

When using a DC power supply, make sure that the DC power supply has an insulated transformer. Do not use a DC power supply with an auto-transformer.

Mutual Interference

When installing two or more proximity sensors face to face or side by side, ensure that the minimum distances given in the Table 2 are maintained.

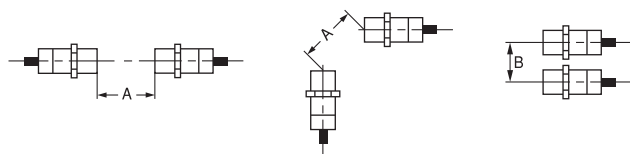

Unit: (mm)

Table 2

Size	M8				M12				M18				M30			
Type	Shielded		Unshielded		Shielded		Unshielded		Shielded		Unshielded		Shielded		Unshielded	
Model E2B-()	S08□S01	S08□S02	S08□N02	S08□N04	M12□S02	M12□S04	M12□N05	M12□N08	M18□S05	M18□S08	M18□N10	M18□N16	M30□S10	M30□S15	M30□N20	M30□N30
A	20	20	80	80	30	30	120	120	50	60	200	200	100	110	300	350
B	15	15	60	60	20	20	100	100	35	35	110	120	70	90	200	300

Wiring

High-tension Lines

Wiring through Metal Conduit:

If there is a power or high-tension line near the cable of the Proximity Sensor, wire the cable through an independent metal conduit to prevent against Proximity Sensor damage or malfunctioning.

Cable Extension

Standard cable length is less than 200 m.
The tractive force is 50 N.

Mounting

Do not tighten the sensor mounting nuts with excessive force.

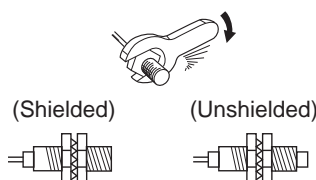

Table 3

Size	Torque
M8	7 N·m
M12	12 N·m
M18	30 N·m
M30	50 N·m

Maintenance and Inspection

Periodically perform the following checks to ensure stable operation of the Proximity Sensor over a long period of time.

1. Check for mounting position, dislocation, looseness, or distortion of the Proximity Sensor and sensing objects.
2. Check for loose wiring and connections, improper contacts, and line breakage.
3. Check for attachment or accumulation of metal powder or dust.
4. Check for abnormal temperature conditions and other environmental conditions.
5. Check for proper lighting of indicators (for models with a set indicator.)

Never disassemble or repair the Sensor.

Environment

Water Resistivity

The Proximity Sensors are tested intensively on water resistance, but in order to ensure maximum performance and life expectancy avoid immersion in water and provide protection from rain or snow.

Operating Environment

Ensure storage and operation of the Proximity Sensor within the given specifications.

Inrush Current

A load that has a large inrush current (e.g., a lamp or motor) will damage the Proximity Sensor, in which case connect the load to the Proximity Sensor through a relay.

<SUITABILITY FOR USE>

OMRON shall not be responsible for conformity with any standards, codes, or regulations that apply to the combination of the products in the customer's application or use of the products.

Take all necessary steps to determine the suitability of the product for the systems, machines, and equipment with which it will be used.

<CHANGE IN SPECIFICATIONS>

Product specifications and accessories may be changed at any time based on improvements and other reasons. Consult with your OMRON representative at any time to confirm actual specifications of purchased product.

READ AND UNDERSTAND THIS DOCUMENT

Please read and understand this document before using the products. Please consult your OMRON representative if you have any questions or comments.

WARRANTY

OMRON's exclusive warranty is that the products are free from defects in materials and workmanship for a period of one year (or other period if specified) from date of sale by OMRON.

OMRON MAKES NO WARRANTY OR REPRESENTATION, EXPRESS OR IMPLIED, REGARDING NON-INFRINGEMENT, MERCHANTABILITY, OR FITNESS FOR PARTICULAR PURPOSE OF THE PRODUCTS. ANY BUYER OR USER ACKNOWLEDGES THAT THE BUYER OR USER ALONE HAS DETERMINED THAT THE PRODUCTS WILL SUITABLY MEET THE REQUIREMENTS OF THEIR INTENDED USE. OMRON DISCLAIMS ALL OTHER WARRANTIES, EXPRESS OR IMPLIED.

LIMITATIONS OF LIABILITY

OMRON SHALL NOT BE RESPONSIBLE FOR SPECIAL, INDIRECT, OR CONSEQUENTIAL DAMAGES, LOSS OF PROFITS OR COMMERCIAL LOSS IN ANY WAY CONNECTED WITH THE PRODUCTS, WHETHER SUCH CLAIM IS BASED ON CONTRACT, WARRANTY, NEGLIGENCE, OR STRICT LIABILITY.

In no event shall responsibility of OMRON for any act exceed the individual price of the product on which liability is asserted.

IN NO EVENT SHALL OMRON BE RESPONSIBLE FOR WARRANTY, REPAIR, OR OTHER CLAIMS REGARDING THE PRODUCTS UNLESS OMRON'S ANALYSIS CONFIRMS THAT THE PRODUCTS WERE PROPERLY HANDLED, STORED, INSTALLED, AND MAINTAINED AND NOT SUBJECT TO CONTAMINATION, ABUSE, MISUSE, OR INAPPROPRIATE MODIFICATION OR REPAIR.

SUITABILITY FOR USE

THE PRODUCTS CONTAINED IN THIS DOCUMENT ARE NOT SAFETY RATED. THEY ARE NOT DESIGNED OR RATED FOR ENSURING SAFETY OF PERSONS, AND SHOULD NOT BE RELIED UPON AS A SAFETY COMPONENT OR PROTECTIVE DEVICE FOR SUCH PURPOSES. Please refer to separate catalogs for OMRON's safety rated products.

OMRON shall not be responsible for conformity with any standards, codes, or regulations that apply to the combination of products in the customer's application or use of the product.

At the customer's request, OMRON will provide applicable third party certification documents identifying ratings and limitations of use that apply to the products. This information by itself is not sufficient for a complete determination of the suitability of the products in combination with the end product, machine, system, or other application or use.

The following are some examples of applications for which particular attention must be given. This is not intended to be an exhaustive list of all possible uses of the products, nor is it intended to imply that the uses listed may be suitable for the products:

- Outdoor use, uses involving potential chemical contamination or electrical interference, or conditions or uses not described in this document.
- Nuclear energy control systems, combustion systems, railroad systems, aviation systems, medical equipment, amusement machines, vehicles, safety equipment, and installations subject to separate industry or government regulations.
- Systems, machines, and equipment that could present a risk to life or property.

Please know and observe all prohibitions of use applicable to the products.

NEVER USE THE PRODUCTS FOR AN APPLICATION INVOLVING SERIOUS RISK TO LIFE OR PROPERTY WITHOUT ENSURING THAT THE SYSTEM AS A WHOLE HAS BEEN DESIGNED TO ADDRESS THE RISKS, AND THAT THE OMRON PRODUCT IS PROPERLY RATED AND INSTALLED FOR THE INTENDED USE WITHIN THE OVERALL EQUIPMENT OR SYSTEM.

PERFORMANCE DATA

Performance data given in this document is provided as a guide for the user in determining suitability and does not constitute a warranty. It may represent the result of OMRON's test conditions, and the users must correlate it to actual application requirements. Actual performance is subject to the OMRON Warranty and Limitations of Liability.

CHANGE IN SPECIFICATIONS

Product specifications and accessories may be changed at any time based on improvements and other reasons.

It is our practice to change model numbers when published ratings or features are changed, or when significant construction changes are made. However, some specifications of the product may be changed without any notice. When in doubt, special model numbers may be assigned to fix or establish key specifications for your application on your request. Please consult with your OMRON representative at any time to confirm actual specifications of purchased products.

DIMENSIONS AND WEIGHTS

Dimensions and weights are nominal and are not to be used for manufacturing purposes, even when tolerances are shown.

ERRORS AND OMISSIONS

The information in this document has been carefully checked and is believed to be accurate; however, no responsibility is assumed for clerical, typographical, or proofreading errors, or omissions.

PROGRAMMABLE PRODUCTS

OMRON shall not be responsible for the user's programming of a programmable product, or any consequence thereof.

COPYRIGHT AND COPY PERMISSION

This document shall not be copied for sales or promotions without permission.

This document is protected by copyright and is intended solely for use in conjunction with the product. Please notify us before copying or reproducing this document in any manner, for any other purpose. If copying or transmitting this document to another, please copy or transmit it in its entirety.

ALL DIMENSIONS SHOWN ARE IN MILLIMETERS.
To convert millimeters into inches, multiply by 0.03937. To convert grams into ounces, multiply by 0.03527.

OMRON Corporation Industrial Automation Company
Tokyo, JAPAN

Contact: www.ia.omron.com

Regional Headquarters
OMRON EUROPE B.V.

Sensor Business Unit
Carl-Benz-Str. 4, D-71154 Nufringen, Germany
Tel: (49) 7032-811-0/Fax: (49) 7032-811-199

OMRON ELECTRONICS LLC

One Commerce Drive Schaumburg,
IL 60173-5302 U.S.A.
Tel: (1) 847-843-7900/Fax: (1) 847-843-7787

OMRON ASIA PACIFIC PTE. LTD.

No. 438A Alexandra Road # 05-05/08 (Lobby 2),
Alexandra Technopark,
Singapore 119967
Tel: (65) 6835-3011/Fax: (65) 6835-2711

OMRON (CHINA) CO., LTD.

Room 2211, Bank of China Tower,
200 Yin Cheng Zhong Road,
PuDong New Area, Shanghai, 200120, China
Tel: (86) 21-5037-2222/Fax: (86) 21-5037-2200

Authorized Distributor:

© OMRON Corporation 2013 All Rights Reserved.
In the interest of product improvement,
specifications are subject to change without notice.

CSM_1_6_0619
Cat. No. D116-E1-02

Printed in Japan
0314(0413)

Mouser Electronics

Authorized Distributor

Click to View Pricing, Inventory, Delivery & Lifecycle Information:

Omron:

[E2B-S08KS02-WP-C2 5M](#) [E2B-M18LN16-WP-C2 5M](#) [E2B-M12KN08-WP-C2 5M](#) [E2B-M12LN08-WP-B2 5M](#) [E2B-M18KN16-WP-B2 5M](#) [E2B-S08KN04-WP-C2 5M](#) [E2B-M12LS04-WP-C2 5M](#) [E2B-M30LS15-WP-C2 5M](#) [E2B-S08LS02-WP-B2 5M](#) [E2B-M30LN30-WP-B2 5M](#) [E2B-M18KN16-WP-C2 5M](#) [E2B-M18LN16-WP-B2 2M](#) [E2B-M12KN08-WP-B2 2M](#) [E2B-M12LS04-WP-C2 2M](#) [E2B-M30LN30-WP-B2 2M](#) [E2B-M12LS04-WP-B2 5M](#) [E2B-M30KS15-WP-C2 5M](#) [E2B-S08KS02-WP-B2 5M](#) [E2B-M12KS04-WP-C2 5M](#) [E2B-M30LS15-WP-B2 5M](#) [E2B-S08LS02-WP-C2 5M](#) [E2B-M18LS08-WP-C2 5M](#) [E2B-M30LN30-WP-C2 5M](#) [E2B-M18KS08-WP-B2 5M](#) [E2B-M12KN08-WP-B2 5M](#) [E2B-M12KS04-WP-B2 5M](#) [E2B-M18LS08-WP-B2 5M](#) [E2B-M30KS15-WP-B2 5M](#) [E2B-M18KS08-WP-C2 5M](#) [E2B-S08LN04-WP-B2 5M](#) [E2B-M18LN16-WP-B2 5M](#) [E2B-S08LN04-WP-C2 5M](#) [E2B-M12LN08-WP-C2 5M](#) [E2B-S08KN04-WP-B2 5M](#) [E2B-M12LN08-WP-B1 2M](#) [E2B-M18KN16-WP-B1 2M](#) [E2B-M18KS08-WP-C1 2M](#) [E2B-M30LS15-WP-B1 2M](#) [E2B-M12KS04-WP-C1 2M](#) [E2B-S08LN04-WP-C1 2M](#) [E2B-M18KN16-WP-C1 5M](#) [E2B-M12KN08-WP-B1 5M](#) [E2B-M12KS04-WP-C1 5M](#) [E2B-M30LS15-WP-B1 5M](#) [E2B-S08LS02-WP-C1 5M](#) [E2B-M12LS04-WP-B1 5M](#) [E2B-M18KN16-WP-B2 2M](#) [E2B-M12LN08-WP-C2 2M](#) [E2B-S08KN04-WP-B2 2M](#) [E2B-S08KS02-WP-B2 2M](#) [E2B-M30KS15-WP-C2 2M](#) [E2B-S08LS02-WP-C1 2M](#) [E2B-M12LN08-WP-C1 2M](#) [E2B-S08KN04-WP-B1 2M](#) [E2B-S08KS02-WP-B1 2M](#) [E2B-M30KS15-WP-C1 2M](#) [E2B-M18KN16-WP-C1 2M](#) [E2B-M18KS08-WP-B1 2M](#) [E2B-M30KS15-WP-C1 5M](#) [E2B-S08KS02-WP-B1 5M](#) [E2B-M18LN16-WP-B1 5M](#) [E2B-S08LN04-WP-C1 5M](#) [E2B-M12KS04-WP-B1 2M](#) [E2B-M30LN30-WP-C1 2M](#) [E2B-M30LS15-WP-C1 5M](#) [E2B-S08LS02-WP-B1 5M](#) [E2B-M12LS04-WP-C1 5M](#) [E2B-S08LN04-WP-B1 5M](#) [E2B-M18KS08-WP-C1 5M](#) [E2B-S08LN04-WP-B2 2M](#) [E2B-S08LS02-WP-B2 2M](#) [E2B-M18LS08-WP-B2 2M](#) [E2B-M30LN30-WP-C2 2M](#) [E2B-M12KN08-WP-C2 2M](#) [E2B-M18LN16-WP-C2 2M](#) [E2B-S08KN04-WP-C1 2M](#) [E2B-S08KS02-WP-C1 2M](#) [E2B-M30KS15-WP-B1 2M](#) [E2B-M18LS08-WP-B1 2M](#) [E2B-M30LN30-WP-B1 5M](#) [E2B-M12LN08-WP-B1 5M](#) [E2B-M18KN16-WP-B1 5M](#) [E2B-S08KN04-WP-C1 5M](#) [E2B-M18LN16-WP-C1 5M](#) [E2B-M12KN08-WP-C1 5M](#) [E2B-M30KS15-WP-B2 2M](#) [E2B-M12LN08-WP-B2 2M](#) [E2B-S08KN04-WP-C2 2M](#) [E2B-S08KS02-WP-C2 2M](#) [E2B-M12LS04-WP-B2 2M](#) [E2B-M12KN08-WP-C1 2M](#) [E2B-M18LN16-WP-C1 2M](#) [E2B-M12LS04-WP-B1 2M](#) [E2B-S08LN04-WP-B1 2M](#) [E2B-S08LS02-WP-B1 2M](#) [E2B-M12KS04-WP-B1 5M](#) [E2B-M18LS08-WP-B1 5M](#) [E2B-M12LN08-WP-C1 5M](#) [E2B-M30KS15-WP-B1 5M](#) [E2B-S08KN04-WP-B1 5M](#)