

# Peripheral Devices







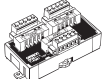
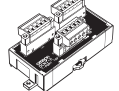
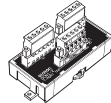
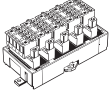
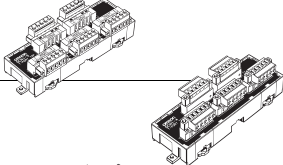
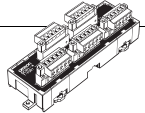
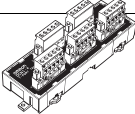

## General-purpose Peripheral Devices

### Peripheral Devices for DeviceNet Communications

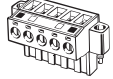





#### Ordering Information

##### ● General-purpose Models

| Product                         | Appearance  | Model           | Specifications   |  |
|---------------------------------|---|-----------------|--|--|
| T-branch Tap for 1 branch line  |    | <b>DCN1-1NC</b> | Cable wiring direction: Toward top<br>Cable lock direction: From top<br>Connector screw direction: From top    | Provided with 3 parallel connectors with clamps (XW4G-05C1-H1-D), standard terminating resistor          |
|                                 |    | <b>DCN1-1C</b>  | Cable wiring direction: Toward side<br>Cable screw direction: From top<br>Connector screw direction: From side | Provided with 3 parallel connectors with screws (XW4B-05C1-H1-D), standard terminating resistor          |
|                                 |    | <b>DCN1-2C</b>  | Cable wiring direction: Toward top<br>Cable screw direction: From side<br>Connector screw direction: From top  |  |
|                                 |   | <b>DCN1-2R</b>  | Cable wiring direction: Toward side<br>Cable screw direction: From top<br>Connector screw direction: From top  | Provided with 3 orthogonal connectors with screws (XW4B-05C1-VIR-D), standard terminating resistor       |
| T-branch Tap for 3 branch lines |  | <b>DCN1-3NC</b> | Cable wiring direction: Toward top<br>Cable lock direction: From top<br>Connector screw direction: From top    | Provided with 5 parallel clamp connectors with screws (XW4G-05C1-H1-D), standard terminating resistor    |
|                                 |  | <b>DCN1-3C</b>  | Cable wiring direction: Toward side<br>Cable screw direction: From top<br>Connector screw direction: From side | Provided with 5 parallel connectors with screws (XW4B-05C1-H1-D), standard terminating resistor          |
|                                 |   | <b>DCN1-4C</b>  | Cable wiring direction: Toward top<br>Cable screw direction: From side<br>Connector screw direction: From top  |  |
|                                 |  | <b>DCN1-4R</b>  | Cable wiring direction: Toward side<br>Cable screw direction: From top<br>Connector screw direction: From top  | Provided with 5 orthogonal clamp connectors with screws (XW4B-05C1-VIR-D), standard terminating resistor |
| Power Supply Tap                |  | <b>DCN1-1P</b>  | Tap provided with 2 connectors, standard terminating resistor, and fuse  |  |

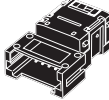
| Product                   |              | Appearance  | Model           | Specifications  |
|---------------------------|--------------|---|-----------------|---|
| Connectors                |              |    | XW4G-05C1-H1-D  | Parallel clamp connector with screws<br>Connector insertion and wiring both performed horizontally.                 |
|                           |              |    | XW4G-05C4-TF-D  | Parallel multi-branching clamp connector with screws<br>Connector insertion and wiring performed in same direction. |
|                           |              |    | XW4B-05C1-H1-D  | Parallel connector with screws<br>Connector insertion and wiring performed in same direction.                       |
|                           |              |    | XW4B-05C4-T-D   | Parallel, screw-less, multi-branching connector<br>Connector insertion and wiring performed in same direction.      |
|                           |              |    | XW4B-05C4-TF-D  | Parallel, multi-branching connector with screws<br>Connector insertion and wiring performed in same direction.      |
|                           |              |    | XW4B-05C1-VIR-D | Orthogonal connector with screws<br>Connector insertion and wiring performed at a right angle.                      |
| DeviceNet Standard Cables | Thin Cables  |    | DCA1-5C10(-B)   | Outer diameter: 7.00 mm<br>Length: 100 m<br>DCA1-5C10-B: Cable color: Blue<br>DCA1-5C10: Cable color: Gray          |
|                           | Thick Cables |   | DCA2-5C10(-B)   | Outer diameter: 11.6 mm<br>Length: 100 m<br>DCA2-5C10-B: Cable color: Blue<br>DCA2-5C10: Cable color: Gray          |
| Terminal-block Terminator |              |  | DRS1-T          | Resistance of 121 Ω   |

● Peripheral Devices for Flat Cables

| Product  | Appearance  | Model     | Specifications  |
|--|---|-----------|---|
| Connector for Flat Cable   |    | DCN4-SF4D | Connector with lock screws for crimping flat cable  |
| Conversion Connector for Standard Thin Cable and Flat Cable            |    | DCN4-BR4D | Used as a set with a DCN4-TR4 when Thin Cable is branched on a branch line.   |
| Power Supply Terminal Block with Terminating Resistance for Flat Cable |    | DCN4-TP4D | Can be used to supply communications power from terminals when Flat Cable is used.  |
| Flat Connector Socket  |    | DCN4-TR4  | Used as a set with a DCN4-BR4 Flat Connector Plug in the following applications. <ul style="list-style-type: none"> <li>• Extending the trunk line</li> <li>• T-branching the trunk line into branch lines</li> </ul>   |
|  |   |           | Used alone in the following applications. <ul style="list-style-type: none"> <li>• Connecting a DCN4-TM4 Terminating Resistor to the trunk line</li> </ul>  |
| Flat Connector Plug  |    | DCN4-BR4  | Used as a set with a DCN4-TR4 Flat Connector Socket in the following applications. <ul style="list-style-type: none"> <li>• Extending the trunk line</li> <li>• T-branching the trunk line into branch lines</li> </ul> |
| Terminating Resistor   |    | DCN4-TM4  | Connector terminating resistor for flat cable. Attached to the DCN4-TR4 Flat Connector Socket at the end of the trunk line.   |
| Flat Cable   |   | DCA4-4F10 | Four-core flat cable (UL 2555)<br>Length: 100 m<br>Conductor diameters: 0.75 mm <sup>2</sup> x 2, 0.5 mm <sup>2</sup> x 2   |
| Simple Manual Crimp Tool   |  | DWT-A01   | Crimping tool for DCN4-TR4 Flat Connector Socket or DCN4-BR4 Flat Connector Plug.   |

Specifications

● General-purpose Models (T-branch Taps)

|                                      |  |
|--------------------------------------|--|
| <b>Rated current</b>                 | Between main lines: 8 A (power supply line) and 2 A (signal line)            |
|                                      | Between main and branch lines: 3 A (power supply line) and 1 A (signal line) |
| <b>Insulation resistance</b>         | 100 MΩ min. (at 500 VDC)   |
| <b>Dielectric strength</b>           | 500 VAC for 1 min, leakage current: 1 mA max.                                |
| <b>Ambient operating temperature</b> | 0°C to 55°C  |

## Dimensions

### ● General-purpose Models

#### T-branch Tap for 1 branch line DCN1-1NC (With Three Branching Connectors)

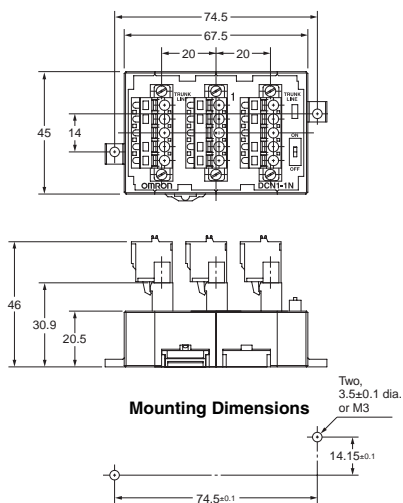
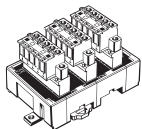

#### Internal Circuit

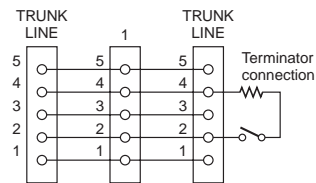

| Terminal No. | Name  |
|--------------|-------|
| 1            | V-    |
| 2            | CAN L |
| 3            | DRAIN |
| 4            | CAN H |
| 5            | V+    |

#### T-branch Tap for 1 branch line DCN1-1C (With Three Branching Connectors)

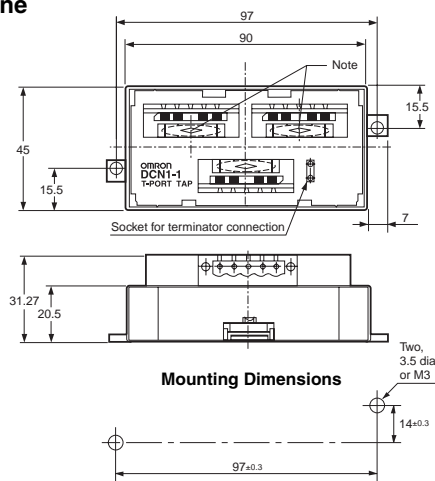
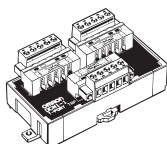

#### Internal Circuit

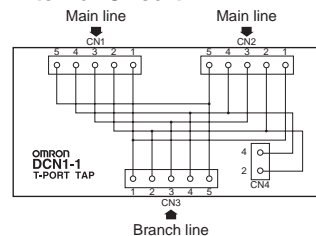

| Terminal No. | Name  |
|--------------|-------|
| 1            | V-    |
| 2            | CAN L |
| 3            | DRAIN |
| 4            | CAN H |
| 5            | V+    |

**Note:** When connecting a branch line to the main line, connect the main line to the connector marked with an asterisk because the resistance between the asterisks is minimal.

#### T-branch Tap for 3 branch lines DCN1-3NC (With Five Branching Connectors)

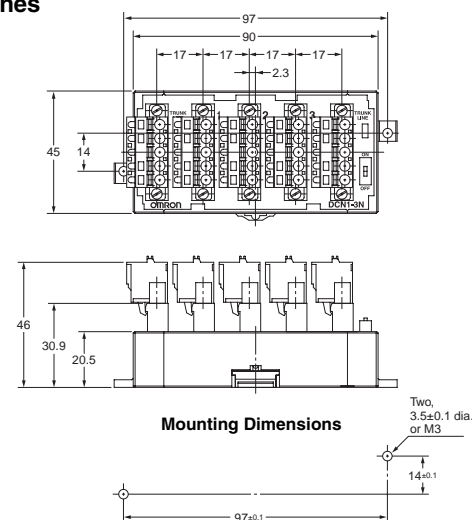
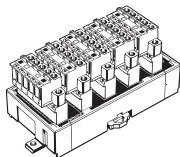

#### Internal Circuit

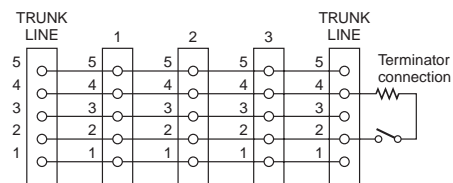

| Terminal No. | Name  |
|--------------|-------|
| 1            | V-    |
| 2            | CAN L |
| 3            | DRAIN |
| 4            | CAN H |
| 5            | V+    |

**T-branch Tap for 3 branch lines  
DCN1-3C  
(With Five Branching  
Connectors)**

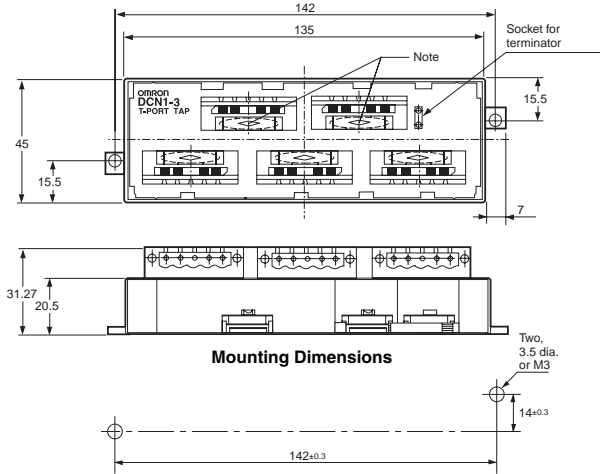
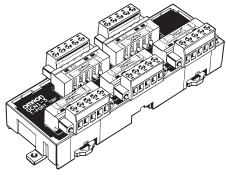

**Mounting Dimensions**

**Internal Circuit**

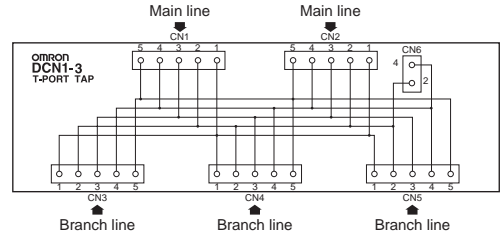

| Terminal No. | Name  |
|--------------|-------|
| 1            | V-    |
| 2            | CAN L |
| 3            | DRAIN |
| 4            | CAN H |
| 5            | V+    |

**Note:** When connecting a branch line to the main line, connect the main line to the connector marked with an asterisk because the resistance between the asterisked portion is minimal.

**Power Supply Tap  
DCN1-1P  
(With Two Branching  
Connectors)**

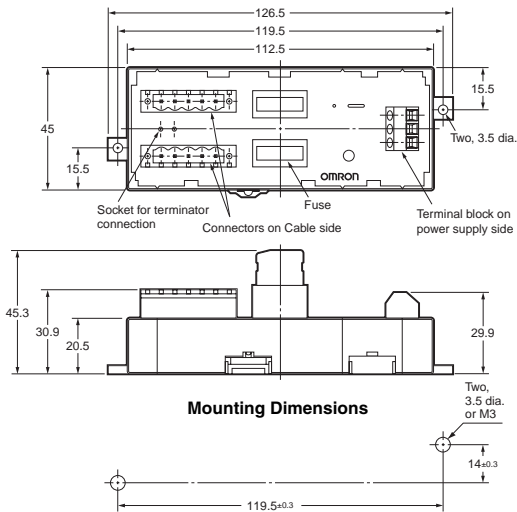
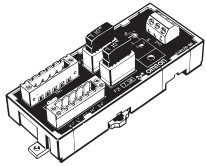

**Mounting Dimensions**

**Internal Circuit**

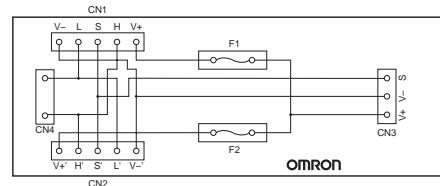

| Terminal No. | Name  |
|--------------|-------|
| V-           | V-    |
| L            | CAN L |
| S            | DRAIN |
| H            | CAN H |
| V+           | V+    |

**DRS1-T  
(Terminal-block Terminator)**

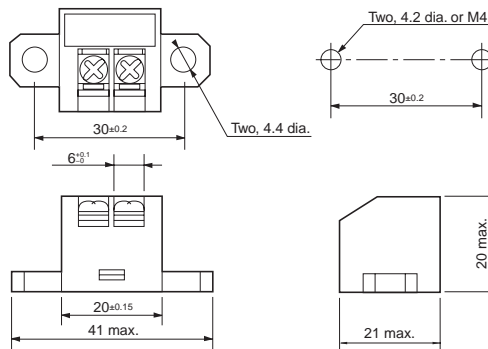
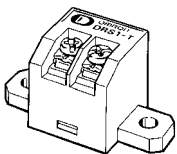

**Mounting Dimensions**

● Flat Cable

Connector for Flat Cable  
DCN4-SF4D

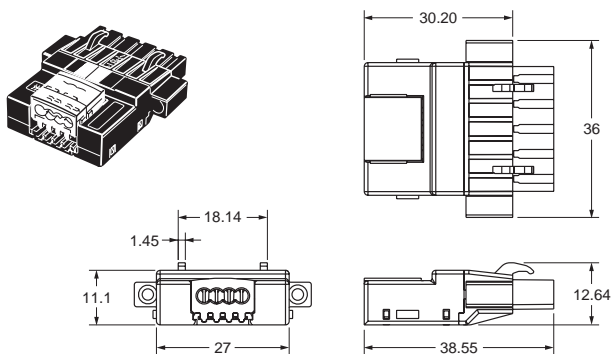

Conversion Connector for Standard Thin Cable and Flat Cable  
DCN4-BR4D

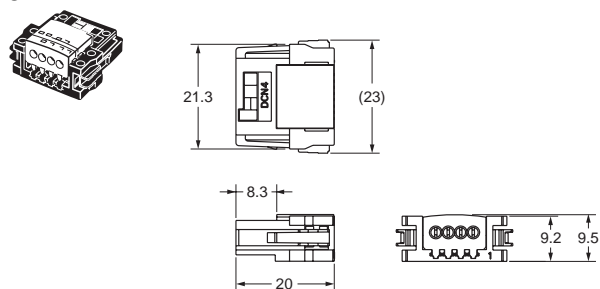

Power Supply Terminal Block with Terminating Resistance for Flat Cable  
DCN4-TP4D

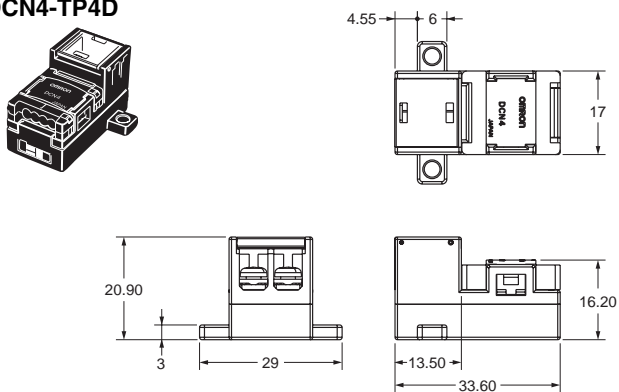

Flat Connector Socket  
DCN4-TR4

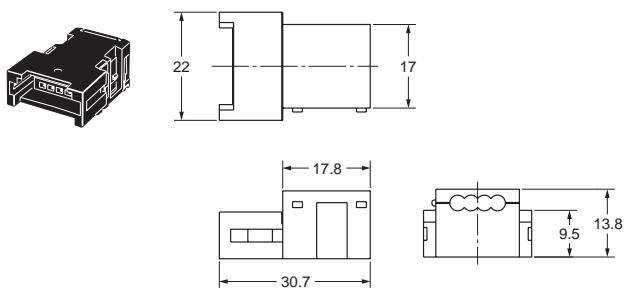

Flat Connector Plug  
DCN4-BR4

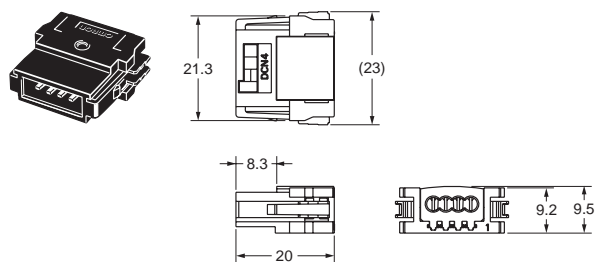

**I/O Peripheral Devices**

**■ I/O Connectors for Connector Terminals**

**● MIL Connectors**

**Applicable Connectors**

| Type  | Model              | Remarks            |
|---|--------------------|--------------------|
| Flat Cable Pressure-welded Connectors       | <b>XG4M-4030-T</b> |                    |
| Pressure-welded Connectors with Loose Wires | Socket             | <b>XG5M-4032-N</b> |
|   |                    | <b>XG5M-4035-N</b> |
|   | Semicover          | <b>XG5S-2001</b>   |
|   | Hood Cover *       | <b>XG5S-4022</b>   |

\* DeviceNet connectors for multi-drop wiring cannot be used with the Hood Cover.

**Cable Models**

| Type  | Model                | Connected device | Applicable models         |
|---|----------------------|------------------|---------------------------|
| Cable with Connectors (1:2)                 | <b>G79-I□□-□□-D1</b> | G7TC/G70D/G70A   | DRT2-ID32ML               |
|   | <b>G79-M□□-□□-D1</b> |                  | DRT2-MD32ML               |
|   | <b>G79-O□□-□□-D1</b> |                  | DRT2-OD32ML/DRT1-OD32ML-1 |
|   | <b>G79-I□□-□□-D2</b> |                  | DRT2-ID32ML-1             |
|   | <b>G79-M□□-□□-D2</b> |                  | DRT2-MD32ML-1             |
| Cable with Connector (1:1)                  | <b>XW2Z-C□□K</b>     |                  |                           |
| Cable with Loose Wires with Crimp Terminals | <b>G79-Y□00C-D1</b>  | --               | All models                |
| Cable with Loose Wires                      | <b>G79-A□00C-D1</b>  |                  |                           |

**Applicable Cables with Connectors**

**● Cables with Connectors (1-to-2 Connection)/G79-□□-□-D□**

| Appearance | Cable length (mm)                 | Cable length (mm) |     | Model                |
|------------|-----------------------------------|-------------------|-----|----------------------|
|            |                                   | (A)               | (B) |                      |
|            | <p>Length without any bending</p> | 500               | 250 | <b>G79-I50-25-D1</b> |
|            |                                   | 750               | 500 | <b>G79-I75-50-D1</b> |
|            |                                   | 500               | 250 | <b>G79-O50-25-D1</b> |
|            |                                   | 750               | 500 | <b>G79-O75-50-D1</b> |
|            |                                   | 500               | 250 | <b>G79-M50-25-D1</b> |
|            |                                   | 750               | 500 | <b>G79-M75-50-D1</b> |
|            |                                   | 500               | 250 | <b>G79-I50-25-D2</b> |
|            |                                   | 750               | 500 | <b>G79-I75-50-D2</b> |
|            |                                   | 500               | 250 | <b>G79-M50-25-D2</b> |
|            |                                   | 750               | 500 | <b>G79-M75-50-D2</b> |

**● Cables with Connectors (1-to-1 Connection)/XW2Z-C□□K**

| Appearance | Cable length (mm) | Model            |
|------------|-------------------|------------------|
|            | 250               | <b>XW2Z-C25K</b> |
|            | 500               | <b>XW2Z-C50K</b> |

**● Cables with Crimp Terminals (at the End of Loose Wires)/G79-Y□C-D1**

| Appearance | Cable length (mm)                        | Model |                     |
|------------|--|-------|---------------------|
|            | Terminal A<br>Connected to device<br>300 | 1,000 | <b>G79-Y100C-D1</b> |
|            |  | 2,000 | <b>G79-Y200C-D1</b> |
|            |  | 5,000 | <b>G79-Y500C-D1</b> |

● Cables with Loose Wires/G79-A□C

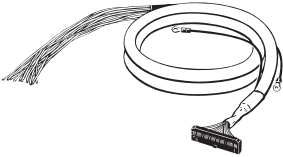
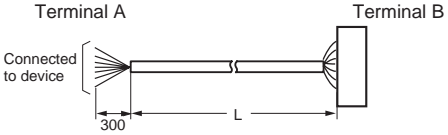
| Appearance  | Cable length (mm)   | Model                        |
|---|---|------------------------------|
|  |  | 2,000<br><b>G79-A200C-D1</b> |
|   |   | 5,000<br><b>G79-A500C-D1</b> |



## I/O Connectors for MULTIPLE I/O TERMINALS



### Applicable Connectors

| Type                          |                           | Model           | Remark                        | Connectable model   |                               |
|-------------------------------|---------------------------|-----------------|-------------------------------|---|-------------------------------|
| Molex connector               | Crimped terminals         | Housing         | 50-57-9403                    | Digital I/O Units<br>GT1-ID16MX(-1)/GT1-OD16MX(-1)<br><br>Analog I/O Units<br>GT1-AD08MX/GT1-DA04MX |                               |
|                               |                           | Chain terminal  | 16-02-0069                    |   | Corresponding to 24 to 30 AWG |
|                               |                           |                 | 16-02-0086                    |   | Corresponding to 22 to 24 AWG |
|                               |                           | Loose terminal  | 16-02-0096                    |   | Corresponding to 24 to 30 AWG |
|                               |                           |                 | 16-02-0102                    |   | Corresponding to 22 to 24 AWG |
|                               | Press-fit tool            | 57036-5000      | Corresponding to 22 to 26 AWG |   |                               |
|                               |                           | 57037-5000      | Corresponding to 24to 30 AWG  |   |                               |
| Fujitsu connector (16 points) | Soldered terminals        | FCN361J024-AU   |                               |   |                               |
|                               | Pressure-welded terminals | FCN367J024-AU/F |                               |   |                               |
|                               | Crimped terminals         | FCN363J024-AU   |                               |   |                               |
| Fujitsu connector (32 points) | Soldered terminals        | FCN361J040-AU   |                               | Digital I/O Units<br>GT1-ID32ML(-1)/GT1-OD32ML(-1)  |                               |
|                               | Pressure-welded terminals | FCN367J040-AU/F |                               |   |                               |
|                               | Crimped terminals         | FCN363J040-AU   |                               |   |                               |
| OMRON D-sub connector         | Pulg                      | XM2A-2501       |                               | Digital I/O Units<br>GT1-ID16DS(-1)/GT1-OD16DS(-1)  |                               |
|                               | Hood                      | XM2S-2513       | #4-40UNC inch screws          |   |                               |

### Applicable Cables with Connectors (Fujitsu Connectors)

| I/O classification        | Model     | Connectable model                   |
|---------------------------|-----------|-------------------------------------|
| Digital input, 16 points  | XW2Z-□□□A | Digital I/O Units<br>GT1-ID16ML(-1) |
|                           | G79-□C    |                                     |
| Digital output, 16 points | XW2Z-□□□A | Digital I/O Units<br>GT1-OD16ML(-1) |
|                           | G79-□C    |                                     |
| Digital input, 32 points  | XW2Z-□□□B | Digital I/O Units<br>GT1-ID32ML(-1) |
|                           | G79-□C□   |                                     |
| Digital output, 32 points | XW2Z-□□□B | Digital I/O Units<br>GT1-OD32ML(-1) |
|                           | G79-□C□   |                                     |

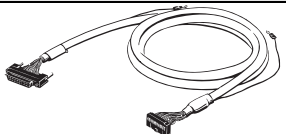
#### ● Cables with Connectors (1-to1 Connection)/G79-□C For Digital Input/Output (16 Points)

| Appearance  | Cable length (mm)   | Model             |
|---|---|-------------------|
|  |  | 1,000<br>G79-100C |
|   | 1,500<br>G79-150C   |                   |
|   | 2,000<br>G79-200C   |                   |
|   | 3,000<br>G79-300C   |                   |
|   | 5,000<br>G79-500C   |                   |

#### ● Cables with Connectors (1-to-2 Connection)/G79-□□C-□, G79-□□C-□ For Digital Input/Output (32 Points)

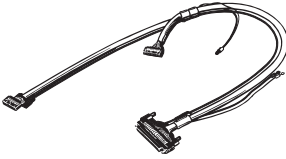
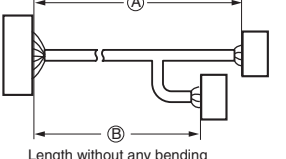
| Appearance  | Cable length (mm)   |       | Model |               |               |
|---|---|-------|-------|---------------|---------------|
|   | ①   | ②     | Input | Output        |               |
|  |  | 1,000 | 750   | G79-I100C-75  | G79-O100C-75  |
|   |   | 1,500 | 1,250 | G79-I150C-125 | G79-O150C-125 |
|   |   | 2,000 | 1,750 | G79-I200C-175 | G79-O200C-175 |
|   |   | 3,000 | 2,750 | G79-I300C-275 | G79-O300C-275 |
|   |   | 5,000 | 4,750 | G79-I500C-475 | G79-O500C-475 |

#### For Digital Input/Output (16 Points)

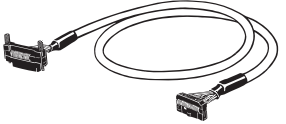
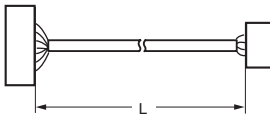
| Appearance  | Cable length (mm)   | Model              |
|---|---|--------------------|
|  |  | 500<br>XW2Z-050A   |
|   |   | 1,000<br>XW2Z-100A |
|   |   | 1,500<br>XW2Z-150A |
|   |   | 2,000<br>XW2Z-200A |
|   |   | 3,000<br>XW2Z-300A |
|   |   | 5,000<br>XW2Z-500A |

#### For Digital Input/Output (32 Points)

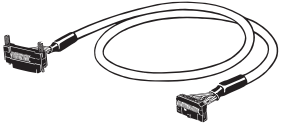
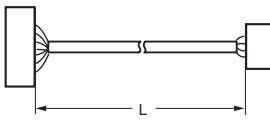
| Appearance  | Cable length (mm)   | Model              |
|---|---|--------------------|
|  |  | 500<br>XW2Z-050B   |
|   |   | 1,000<br>XW2Z-100B |
|   |   | 1,500<br>XW2Z-150B |
|   |   | 2,000<br>XW2Z-200B |
|   |   | 3,000<br>XW2Z-300B |
|   |   | 5,000<br>XW2Z-500B |

## I/O Connector for Programmable Slaves

### Applicable Connector Terminal Conversion Units

| Applicable cable | Connected product | Remarks   |
|------------------|-------------------|---|
| XW2Z-□□□A        | XW2D-20G6         | Slim type<br>(with M3 screw terminals)  |
|                  | XW2B-20G4         | Flat cable connectors<br>(with M3 terminal screws for flat-blade screwdriver) |

### Applicable Cables with Connectors

● Cables with Connectors/XW2Z  
For Digital Input/Output (16 Points)

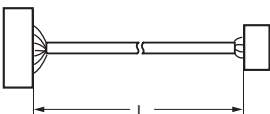
| Appearance  | Cable length (mm)   | Model     |
|---|---|-----------|
|  |  | 500       |
|   |   | XW2Z-050A |
|   |   | 1,000     |
|   |   | XW2Z-100A |
|   |   | 1,500     |
|   |   | XW2Z-150A |
| 2,000   |   |           |
| XW2Z-200A   |   |           |
| 3,000   |   |           |
| XW2Z-300A   |   |           |
| 5,000   |   |           |
| XW2Z-500A   |   |           |

# Peripheral Devices for Environment-resistive Slaves



## Peripheral Devices for DeviceNet Communications

### Ordering Information





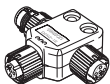
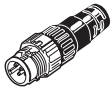
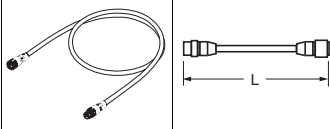
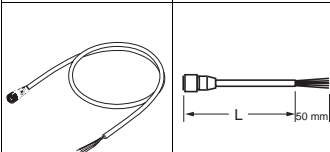
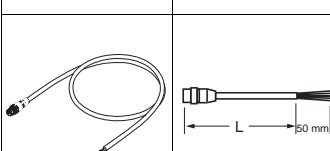





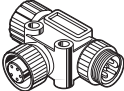
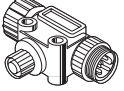

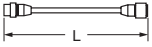
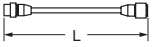
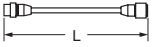
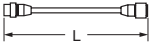
● Environment-resistive Connection Products (for Thin Cable, M12 Micro Connectors)

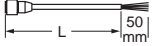
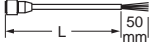
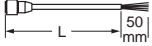
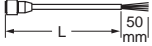
| Product                                     | Appearance  | Model                                     | Specifications                                     |
|---|---|---|--|
| Sealed Assembling-type Connector (male)     |   | XS2G-D5S7                                 | For communications (plug)                          |
| Sealed Assembling-type Connector (female)   |   | XS2C-D5S7                                 | For communications (socket)                        |
| Sealed T-branch Connector                   |   | DCN2-1                                    | For 1 branch line                                  |
| Sealed Connector with Terminating Resistor  |   | DRS2-1                                    | Plug   |
|   |   | DRS2-2                                    | Socket   |
| Cables with Sealed Connectors               |   | DCA1-5CNC5W1                              | Length (L): 0.5 m                                  |
|   |   | DCA1-5CN01W1                              | Length (L): 1 m                                    |
|   |   | DCA1-5CN02W1                              | Length (L): 2 m                                    |
|   |   | DCA1-5CN03W1                              | Length (L): 3 m                                    |
|   |   | DCA1-5CN05W1                              | Length (L): 5 m                                    |
|   |   | DCA1-5CN10W1                              | Length (L): 10 m                                   |
|   |   | DCA1-5CNC5F1                              | Length (L): 0.5 m                                  |
|   |   | DCA1-5CN01F1                              | Length (L): 1 m                                    |
|   |   | DCA1-5CN02F1                              | Length (L): 2 m                                    |
|   |   | DCA1-5CN03F1                              | Length (L): 3 m                                    |
|   |   | DCA1-5CN05F1                              | Length (L): 5 m                                    |
|   |   | DCA1-5CN10F1                              | Length (L): 10 m                                   |
|   |   | DCA1-5CNC5H1                              | Length (L): 0.5 m                                  |
|   |   | DCA1-5CN01H1                              | Length (L): 1 m                                    |
|   |   | DCA1-5CN02H1                              | Length (L): 2 m                                    |
| Shielded Panel-mounting Connectors (female) |   | DCA1-5CNC5P1                              | Panel-mounting connector (socket) with 0.5-m cable |
|   |   | XS2P-D522-2                               | Panel-mounting connector socket                    |
|   |   | Shielded Panel-mounting Connectors (male) |  |
| XS2M-D524-4                                 | Panel-mounting connector (plug) with solder-cup terminals |   |  |
| Waterproof cover (for socket)               |   | XS2Z-22                                   | Used to cover an unused connector section          |
| Dust cover (for socket)                     |   | XS2Z-15                                   |  |

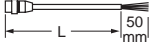
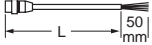
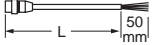
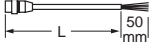
● Environment-resistive Models (for Thin Wires and M12 Micro Connectors) 

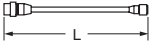
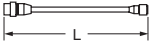
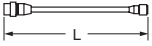
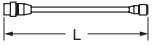
| Product                                   | Appearance  | Model        | Specifications       |
|---|---|--------------|----------------------|
| Sealed T-branch Connector                 |    | DCN2-1S      | For 1 branch line    |
| Sealed Assembling type Connector (female) |    | DRS2-1S      | Plug                 |
|   |   | DRS2-2S      | Socket               |
| Connectors with Shielded Cables           |    | DCA1-5CSC5W1 | Length (L): 0.5 m    |
|   |   | DCA1-5CS01W1 | Length (L): 1 m      |
|   |   | DCA1-5CS02W1 | Length (L): 2 m      |
|   |   | DCA1-5CS03W1 | Length (L): 3 m      |
|   |   | DCA1-5CS05W1 | Length (L): 5 m      |
|   |   | DCA1-5CS10W1 | Length (L): 10 m     |
|   |    | DCA1-5CSC5F1 | Length (L): 0.5 m    |
|   |   | DCA1-5CS01F1 | Length (L): 1 m      |
|   |   | DCA1-5CS02F1 | Length (L): 2 m      |
|   |   | DCA1-5CS03F1 | Length (L): 3 m      |
|   |   | DCA1-5CS05F1 | Length (L): 5 m      |
|   |   | DCA1-5CS10F1 | Length (L): 10 m     |
|   |    | DCA1-5CSC5H1 | Length (L): 0.5 m    |
|   |   | DCA1-5CS01H1 | Length (L): 1 m      |
|   |   | DCA1-5CS02H1 | Length (L): 2 m      |
|   |   | DCA1-5CS03H1 | Length (L): 3 m      |
|   |   | DCA1-5CS05H1 | Length (L): 5 m      |
|   |   | DCA1-5CS10H1 | Length (L): 10 m     |
| Shielded Branch Relay Box                 |  | DCN2-S4C5H1  | 4 ports, 0.5-m cable |
|   |  | DCN2-S8C5H1  | 8 ports, 0.5-m cable |

● Environment-resistive Models for Thick Wires with 7/8-16UN Mini Connectors

| Product                                    | Appearance  | Model   | Specifications  |                  |  |  |
|--|---|---|---|------------------|--|--|
| Sealed T-branch Connector                  |    | DCN3-11   | T-branch Connector  |                  |  |  |
|  |    | DCN3-12   | T-branch Connector (Branch connector is M12.)                                       |                  |  |  |
| Sealed Connector with Terminating Resistor |    | DRS3-1  | Plug  |                  |  |  |
| Cables with Sealed Connectors              |    |    | DCA2-5CN01W1  | Length (L): 1 m  | Cable with connectors on both ends       |  |
|  |   |    | DCA2-5CN02W1  | Length (L): 2 m  |  |  |
|  |   |    | DCA2-5CN05W1  | Length (L): 5 m  |  |  |
|  |   |    | DCA2-5CN10W1  | Length (L): 10 m |  |  |
|  |    |    | DCA2-5CN01F1  | Length (L): 1 m  | Cable with connector on one end (socket) |  |
|  |   |    | DCA2-5CN02F1  | Length (L): 2 m  |  |  |
|  |   |    | DCA2-5CN05F1  | Length (L): 5 m  |  |  |
|  |   |    | DCA2-5CN10F1  | Length (L): 10 m |  |  |
|  |    |    | DCA2-5CN01H1  | Length (L): 1 m  | Cable with connector on one end (plug)   |  |
|  |   |    | DCA2-5CN02H1  | Length (L): 2 m  |  |  |
|  |   |    | DCA2-5CN05H1  | Length (L): 5 m  |  |  |
|  |   |    | DCA2-5CN10H1  | Length (L): 10 m |  |  |
|  |   |  |  | DCA1-5CN01W5     | Length (L): 1 m                          | Cable with connectors on both ends<br>Thin cable<br>M12 socket |
|  |   |   |  | DCA1-5CN02W5     | Length (L): 2 m                          |  |
|  |   |   |  | DCA1-5CN05W5     | Length (L): 5 m                          |  |
|  |   |   |  | DCA1-5CN10W5     | Length (L): 10 m                         |  |
| Panel-mounting Connector (female)          |  | DCA2-5CNC5P1  | Panel-mounting connector (socket) with 0.5-m cable                                  |                  |  |  |
| Panel-mounting Connector (male)            |  | DCA2-5CNC5M1  | Panel-mounting connector (plug) with 0.5-m cable                                    |                  |  |  |
| Panel-mounting Connector (male)            |  | XS4M-D521-1   | Panel-mounting connector (plug)<br>DIP terminals                                    |                  |  |  |
| Waterproof Cap (for Plug)                  | -   | XS4Z-11   | Used to cover an unused connector section.  |                  |  |  |
| Waterproof Cap (for Socket)                | -   | XS4Z-12   |   |                  |  |  |

## Specifications

### ● Environment-resistive Connection Products (for Thin Cable, M12 Micro Connectors)

| Type                            | Connectors with Cables<br>DCA1-5CN□□□1  | T-branch Connector<br>DCN2-1 | Assembling-type Connector<br>XS2□-D5S7 | Connectors with Terminating Resistor<br>DRS2-□ |
|---------------------------------|---|------------------------------|--|--|
| Rated current                   | 3 A   |                              |  |  |
| Rated voltage                   | 125 VDC   |                              |  |  |
| Contact resistance (connector)  | 40 mΩ max. (at 20 mVDC max. and 100 mA max.)  |                              |  |  |
| Insulation resistance           | 1,000 MΩ min. (at 500 VDC)  |                              |  |  |
| Dielectric strength (connector) | 1,500 VAC for 60 seconds (leakage current: 1 mA max.)   |                              |  |  |
| Ambient operating temperature   | -20°C to 65°C   |                              |  |  |
| Storage temperature range       | -25°C to 70°C   |                              |  |  |
| Degree of protection            | IEC IP67  |                              |  |  |
| Insertion durability            | 200 times   |                              |  |  |
| Cable strength                  | 98 N for 15 s   | --                           |  |  |
| Vibration resistance            | No current interruptions of more than 1 μs while performing simple vibrations at either 10 to 500 Hz with 1.52-mm full amplitude or at acceleration 100 m/s <sup>2</sup> , whichever is smaller |                              |  |  |

### ● Environment-resistive Models (for Thin Wires and M12 Micro Connectors)

| Type                            | Connectors with Cables<br>DCA1-5CS□□□1  | T-branch Connector<br>DCN2-1S | Connectors with Terminating Resistor<br>DRS2-□S | Branch Relay Box<br>DCN2-S□C5H |
|---------------------------------|---|-------------------------------|---|--------------------------------|
| Rated current                   | 3 A   |                               |   |                                |
| Rated voltage                   | 125 VDC   |                               |   |                                |
| Contact resistance (connector)  | 40 mΩ max. (at 20 mVDC max. and 100 mA max.)  |                               |   |                                |
| Insulation resistance           | 1,000 MΩ min. (at 500 VDC)  |                               |   |                                |
| Dielectric strength (connector) | 1,500 VAC for 60 seconds (leakage current: 1 mA max.)   |                               |   | 1,000 VAC for 60 seconds       |
| Ambient operating temperature   | -20°C to 65°C   |                               |   |                                |
| Storage temperature range       | -25°C to 70°C   |                               |   |                                |
| Degree of protection            | IEC IP67  |                               |   |                                |
| Insertion durability            | 200 times   |                               |   |                                |
| Cable strength                  | 98 N for 15 s   | --                            |   |                                |
| Vibration resistance            | No current interruptions of more than 1 μs while performing simple vibrations at either 10 to 500 Hz with 1.52-mm full amplitude or at acceleration 100 m/s <sup>2</sup> , whichever is smaller |                               |   |                                |
| Lock strength                   | Pulling: 100 N/15 s, Rotating: 1 N·m/15 s   |                               |   |                                |
| Lock force                      | 0.1 to 0.25 N·m   |                               |   |                                |

### ● Environment-resistive Models for Thick Wires with 7/8-16UN Mini Connectors

| Type                            | Connectors with Thick Cables<br>DCA2-5CN□□□1  | Connectors with Thin Cables<br>DCA1-5CN□□□W5 | T-branch Connector<br>DCN3-11 | T-branch Connector<br>DCN3-12 | Connectors with Terminating Resistor<br>DRS3-1 | Panel Mounting Connector<br>DCA2-5CNC5P1 | Panel Mounting Connector<br>XS4M-D521-1 |
|---------------------------------|---|--|-------------------------------|-------------------------------|--|--|---|
| Rated current                   | 8 A   | 3 A  | 8 A                           | 3 A *                         | 8 A  |  |   |
| Rated voltage                   | 125 VDC   |  |                               |                               |  |  |   |
| Contact resistance (connector)  | 30 mΩ max. (at 20 mVDC max. and 100 mA max.)  |  |                               |                               |  |  |   |
| Insulation resistance           | 1,000 MΩ min. (at 500 VDC)  |  |                               |                               |  |  |   |
| Dielectric strength (connector) | 1,500 VAC for 60 seconds (leakage current: 1 mA max.)   |  |                               |                               |  |  |   |
| Ambient operating temperature   | -20°C to 65°C   |  |                               |                               |  |  |   |
| Storage temperature range       | -25°C to 70°C   |  |                               |                               |  |  |   |
| Degree of protection            | IEC IP67  |  |                               |                               |  |  |   |
| Insertion durability            | 200 times   |  |                               |                               |  |  |   |
| Cable strength                  | 98 N for 15 s   |  |                               | --                            |  | 98 N for 15 s                            | --                                      |
| Vibration resistance            | No current interruptions of more than 1 μs while performing simple vibrations at either 10 to 500 Hz with 1.52-mm full amplitude or at acceleration 100 m/s <sup>2</sup> , whichever is smaller |  |                               |                               |  |  |   |

\* The rated current between thick wires is 8 A.

## Dimensions

### ● Environment-resistive Connection Products (for Thin Cable, M12 Micro Connectors)

#### Cables with Connectors on Both Ends DCA1-5CN□□W1

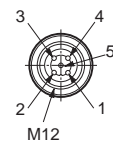
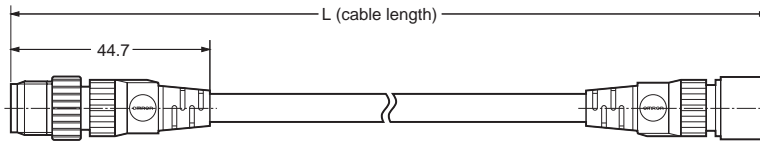
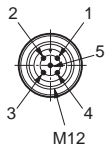
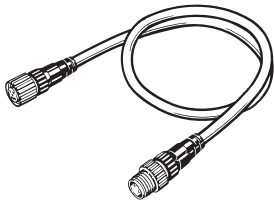

#### Wiring

| Terminal No. | Color | Name  |
|--------------|-------|-------|
| 1            | -     | DRAIN |
| 2            | Red   | V+    |
| 3            | Black | V-    |
| 4            | White | CAN H |
| 5            | Blue  | CAN L |

#### Cables with Connector on Single End (Socket) DCA1-5CN□□F1

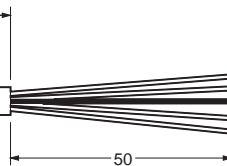
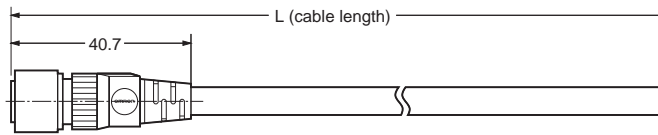
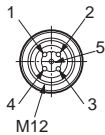
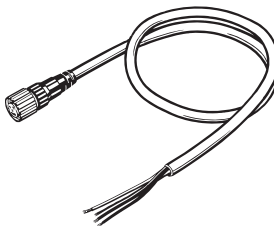

#### Wiring

| Terminal No. | Color | Name  |
|--------------|-------|-------|
| 1            | -     | DRAIN |
| 2            | Red   | V+    |
| 3            | Black | V-    |
| 4            | White | CAN H |
| 5            | Blue  | CAN L |

#### Cables with Connector on Single End (Plug) DCA1-5CN□□H1

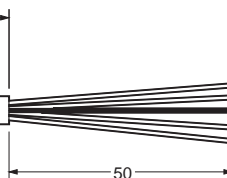
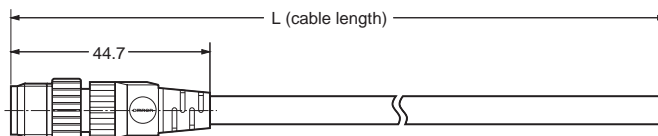
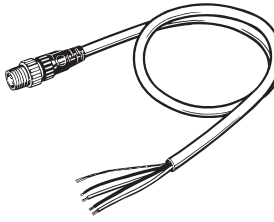

#### Wiring

| Terminal No. | Color | Name  |
|--------------|-------|-------|
| 1            | -     | DRAIN |
| 2            | Red   | V+    |
| 3            | Black | V-    |
| 4            | White | CAN H |
| 5            | Blue  | CAN L |

#### T-branch Connector DCN2-1

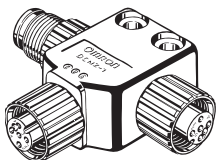

#### Connections Diagram

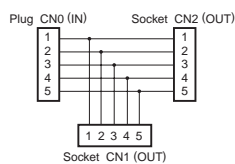

#### Wiring

| Terminal No. | Name   |
|--------------|--------|
| 1            | SHIELD |
| 2            | V+     |
| 3            | V-     |
| 4            | CAN H  |
| 5            | CAN L  |

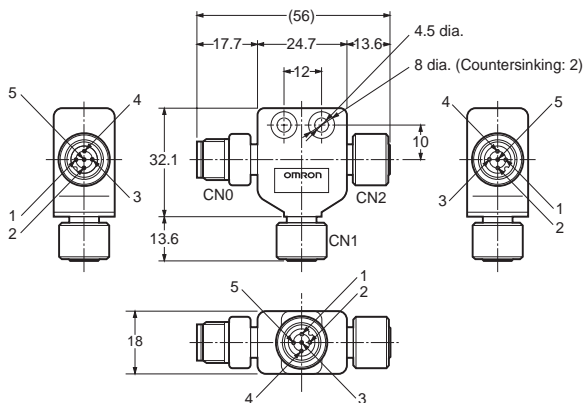

#### Connectors with Terminating Resistance

##### DRS2-1 (Plug) DRS2-2 (Socket)



#### Wiring

| Terminal No. | Name                      |
|--------------|---------------------------|
| 1            | DRAIN : NC                |
| 2            | V+ : NC                   |
| 3            | V- : NC                   |
| 4            | CAN H : $\sim 121 \Omega$ |
| 5            | CAN L : $\sim 121 \Omega$ |

**Note:** Terminating resistance (121  $\Omega$ ) is connected between terminals 4 and 5.

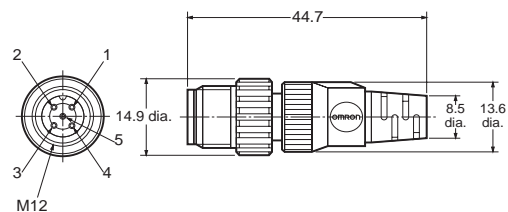

**Note:** The diagram shows the DRS2-1 (plug).

**Panel-mounting Connector (Socket) with 0.5 m Cable**  
**DCA1-5CNC5P1**

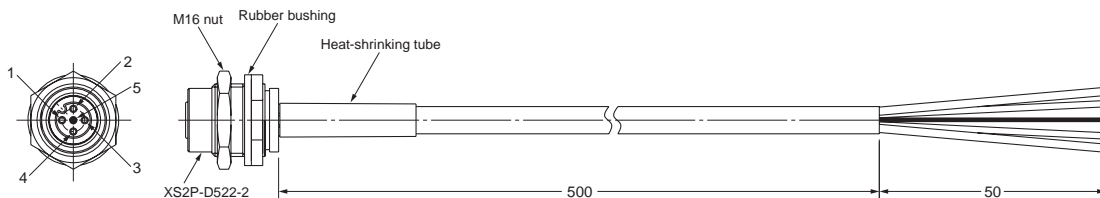
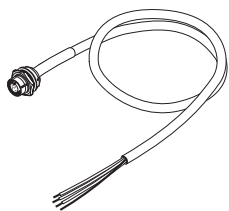

**Wiring**

| Terminal No. | Color | Name  |
|--------------|-------|-------|
| 1            | -     | DRAIN |
| 2            | Red   | V+    |
| 3            | Black | V-    |
| 4            | White | CAN H |
| 5            | Blue  | CAN L |

**Panel-mounting Connector (Socket), Solder-cup Terminals**  
**XS2P-D522-2**

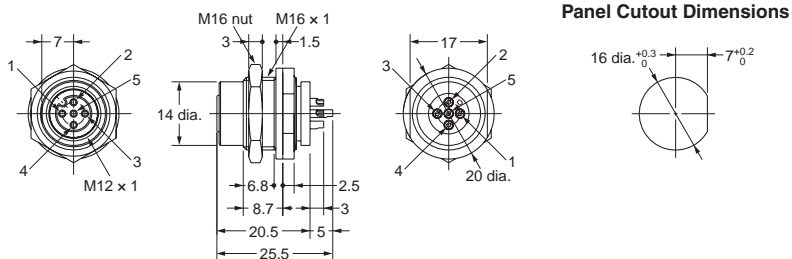

**Panel Cutout Dimensions**

**Panel-mounting Connector (Plug) with 0.5 m Cable**  
**DCA1-5CNC5M1**

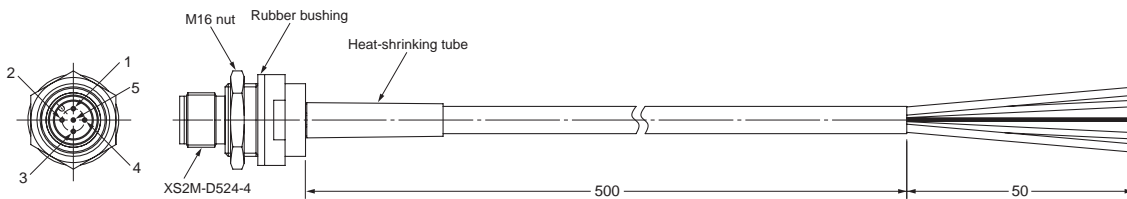
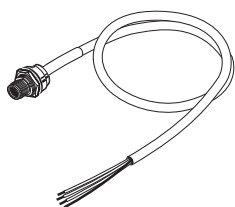

**Wiring**

| Terminal No. | Color | Name  |
|--------------|-------|-------|
| 1            | -     | DRAIN |
| 2            | Red   | V+    |
| 3            | Black | V-    |
| 4            | White | CAN H |
| 5            | Blue  | CAN L |

**Panel-mounting Connector (Socket), Solder-cup Terminals**  
**XS2M-D524-4**

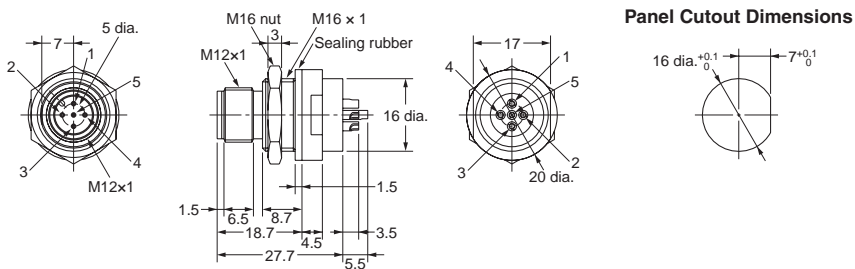
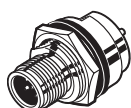

**Panel Cutout Dimensions**

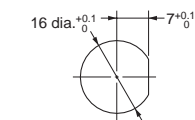



● Environment-resistive Models (for Thin Wires and M12 Micro Connectors)

Cables with Connectors on Both Ends  
DCA1-5CS□□W1

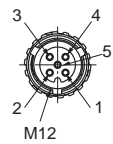
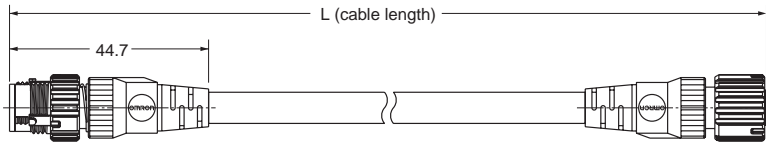
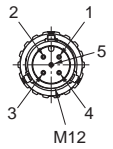
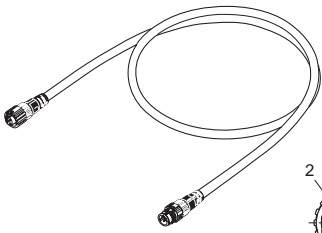

Wiring

| Terminal No. | Color | Name  |
|--------------|-------|-------|
| 1            | -     | DRAIN |
| 2            | Red   | V+    |
| 3            | Black | V-    |
| 4            | White | CAN H |
| 5            | Blue  | CAN L |

Cables with Connector on Single End (Socket)  
DCA1-5CS□□F1

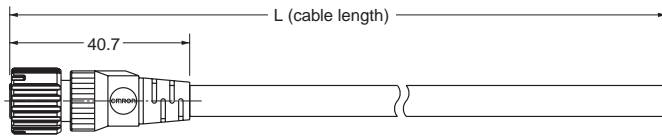
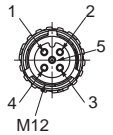
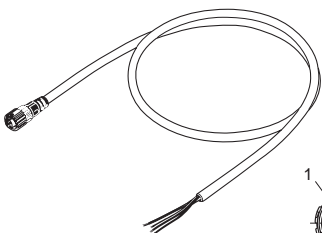

Wiring

| Terminal No. | Color | Name  |
|--------------|-------|-------|
| 1            | -     | DRAIN |
| 2            | Red   | V+    |
| 3            | Black | V-    |
| 4            | White | CAN H |
| 5            | Blue  | CAN L |

Cables with Connector on Single End (Plug)  
DCA1-5CS□□H1

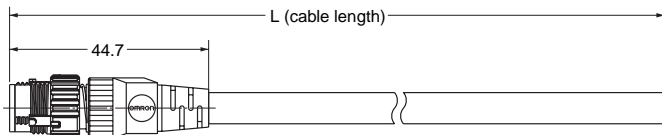
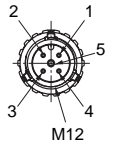
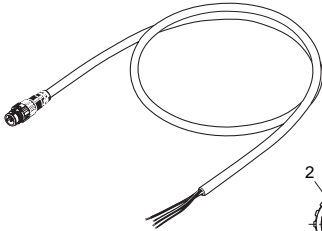

Wiring

| Terminal No. | Color | Name  |
|--------------|-------|-------|
| 1            | -     | DRAIN |
| 2            | Red   | V+    |
| 3            | Black | V-    |
| 4            | White | CAN H |
| 5            | Blue  | CAN L |

T-branch Connector  
DCN2-1S

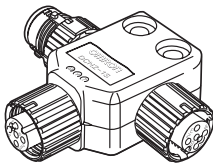

Connections Diagram

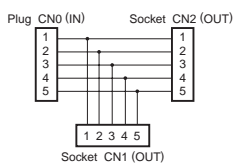

Wiring

| Terminal No. | Name   |
|--------------|--------|
| 1            | SHIELD |
| 2            | V+     |
| 3            | V-     |
| 4            | CAN H  |
| 5            | CAN L  |

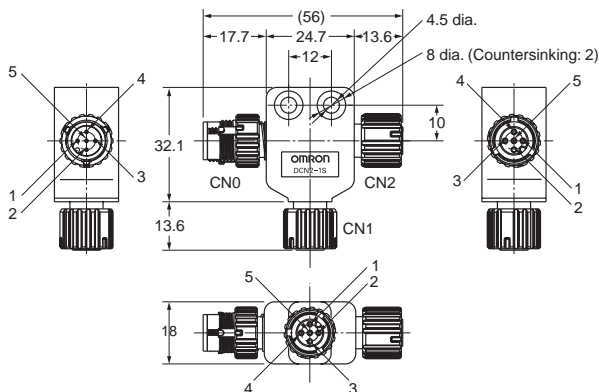

Connectors with Terminating Resistance

DRS2-1S (Plug)  
DRS2-2S (Socket)

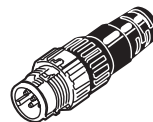

Wiring

| Terminal No. | Name                               |
|--------------|------------------------------------|
| 1            | DRAIN : NC                         |
| 2            | V+ : NC                            |
| 3            | V- : NC                            |
| 4            | CAN H : $\rightarrow$ 121 $\Omega$ |
| 5            | CAN L : $\rightarrow$ 121 $\Omega$ |

Note: Terminating resistance (121  $\Omega$ ) is connected between terminals 4 and 5.

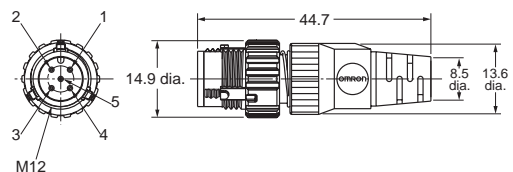

Note: The diagram shows the DRS2-1 (plug).

**Shielded Branch Relay Box with Four Ports**  
DCN2-S4C5H1

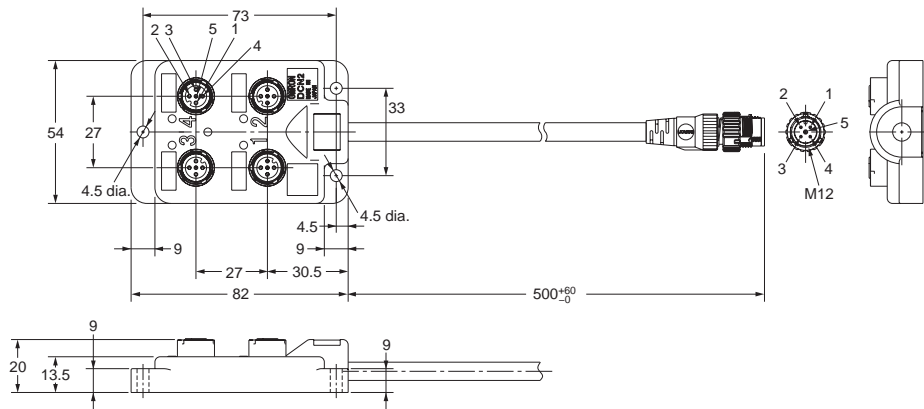
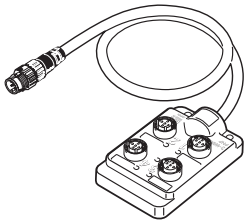

**Connections Diagram**

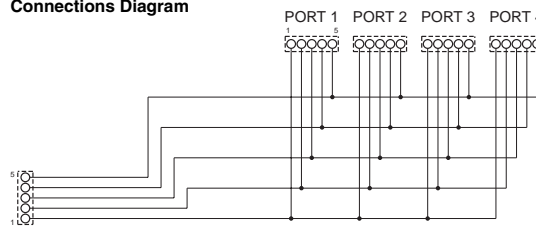

**Wiring**

| Terminal No. | Color | Name  |
|--------------|-------|-------|
| 1            | -     | DRAIN |
| 2            | Red   | V+    |
| 3            | Black | V-    |
| 4            | White | CAN H |
| 5            | Blue  | CAN L |

**Shielded Branch Relay Box with Eight Ports**  
DCN2-S8C5H1

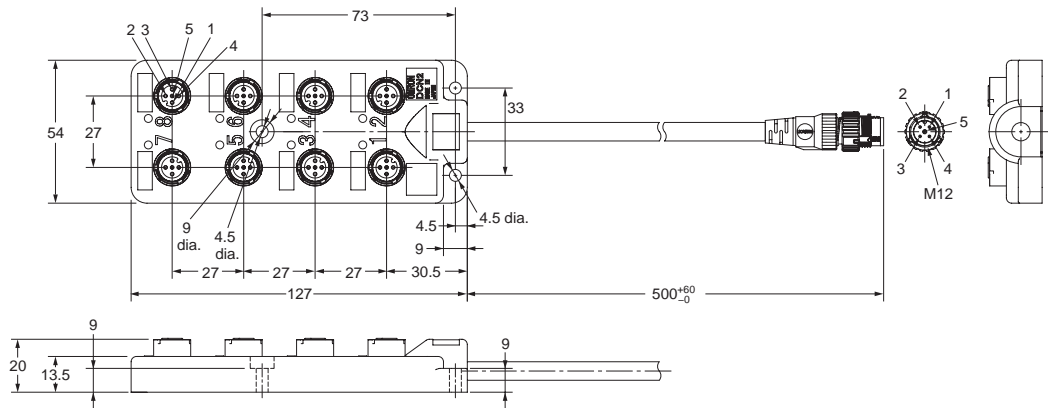
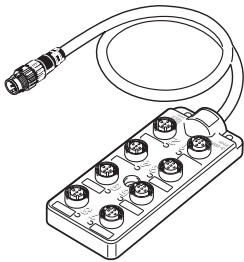

**Connections Diagram**

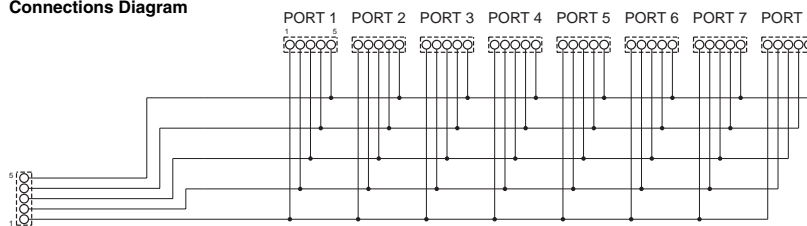

**Wiring**

| Terminal No. | Color | Name  |
|--------------|-------|-------|
| 1            | -     | DRAIN |
| 2            | Red   | V+    |
| 3            | Black | V-    |
| 4            | White | CAN H |
| 5            | Blue  | CAN L |

● Environment-resistive Models for Thick Wires with 7/8-16UN Mini Connectors

Thick Cable with Connectors on Both Ends (5 Conductors for Communications)  
DCA2-5CN□□W1

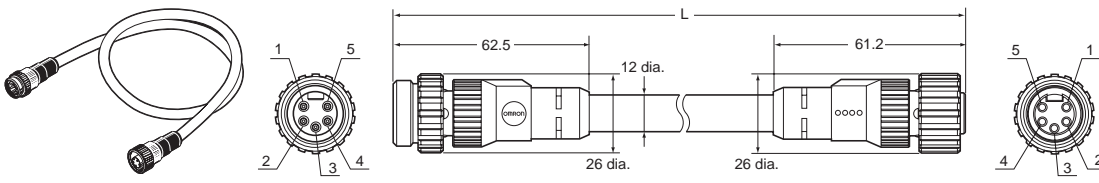

Wiring

| Terminal No. | Color | Name  |
|--------------|-------|-------|
| 1            | -     | DRAIN |
| 2            | Red   | V+    |
| 3            | Black | V-    |
| 4            | White | CAN H |
| 5            | Blue  | CAN L |

Thick Cable with Connector Socket on One End (5 Conductors for Communications)  
DCA2-5CN□□F1

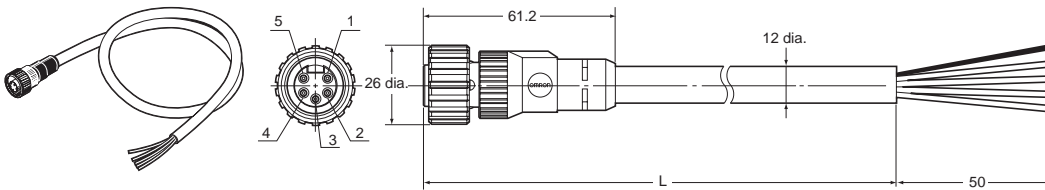

Wiring

| Terminal No. | Color | Name  |
|--------------|-------|-------|
| 1            | -     | DRAIN |
| 2            | Red   | V+    |
| 3            | Black | V-    |
| 4            | White | CAN H |
| 5            | Blue  | CAN L |

Thick Cable with Connector Plug on One End (5 Conductors for Communications)  
DCA2-5CN□□H1

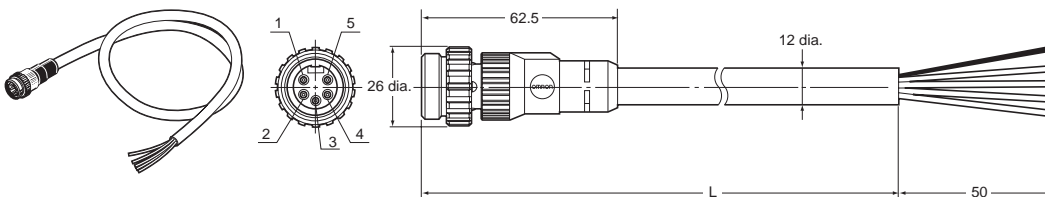

Wiring

| Terminal No. | Color | Name  |
|--------------|-------|-------|
| 1            | -     | DRAIN |
| 2            | Red   | V+    |
| 3            | Black | V-    |
| 4            | White | CAN H |
| 5            | Blue  | CAN L |

Thin Cable with Connectors on Both Ends (5 Conductors for Communications)  
DCA1-5CN□□W5

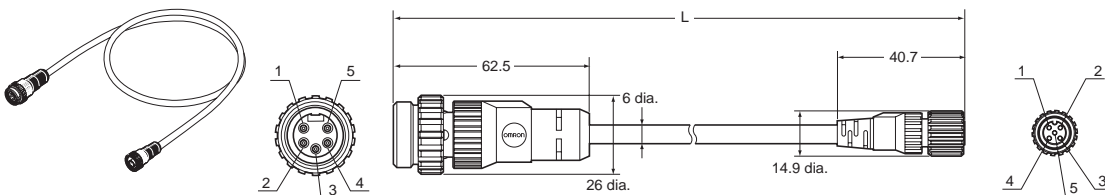

Wiring

| Terminal No. | Color | Name  |
|--------------|-------|-------|
| 1            | -     | DRAIN |
| 2            | Red   | V+    |
| 3            | Black | V-    |
| 4            | White | CAN H |
| 5            | Blue  | CAN L |

Thin Cable with Panel-mounting Connector Socket on One End (5 Conductors for Communications)  
DCA2-5CNC5P1

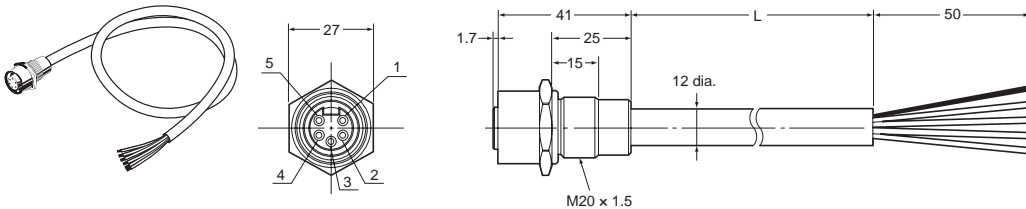

Note: A rubber seal and nut for panel mounting are included.

Panel Cutout Dimensions

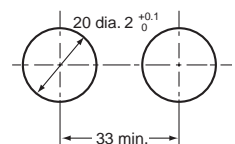

Wiring

| Terminal No. | Color | Name  |
|--------------|-------|-------|
| 1            | -     | DRAIN |
| 2            | Red   | V+    |
| 3            | Black | V-    |
| 4            | White | CAN H |
| 5            | Blue  | CAN L |

**Panel-mounting Connector (Plug) with 0.5 m Cable  
DCA2-5CNC5M1**

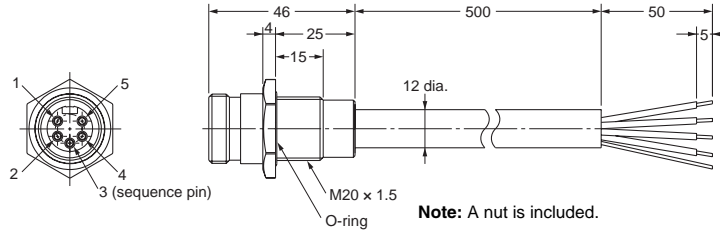
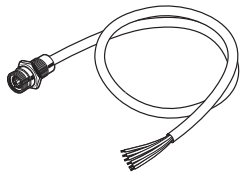

**Wiring**

| Terminal No. | Color | Name  |
|--------------|-------|-------|
| 1            | -     | DRAIN |
| 2            | Red   | V+    |
| 3            | Black | V-    |
| 4            | White | CAN H |
| 5            | Blue  | CAN L |

**T-branch Connector (5 Conductors for Communications,  
Thick Wire Branch Line)  
DCN3-11**

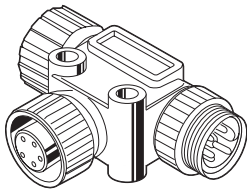

**Connections Diagram**

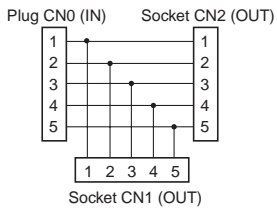

**Wiring**

| Terminal No. | Name  |
|--------------|-------|
| 1            | DRAIN |
| 2            | V+    |
| 3            | V-    |
| 4            | CAN H |
| 5            | CAN L |

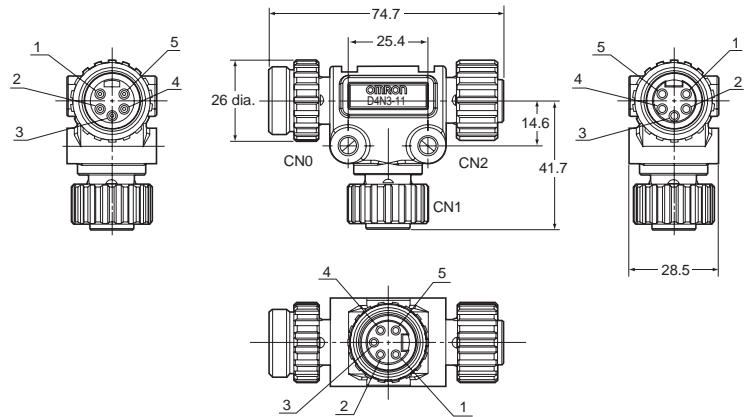

**T-branch Connector (5 Conductors for Communications,  
Thin Wire Branch Line)  
DCN3-12**

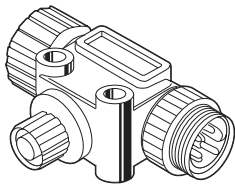

**Connections Diagram**

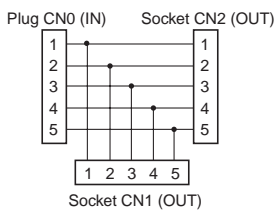

**Wiring**

| Terminal No. | Name  |
|--------------|-------|
| 1            | DRAIN |
| 2            | V+    |
| 3            | V-    |
| 4            | CAN H |
| 5            | CAN L |

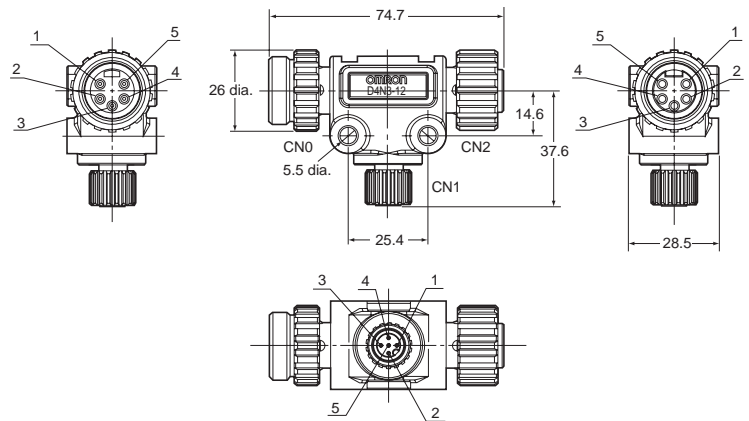

**Connector (Plug) with Terminating Resistance  
DRS3-1**

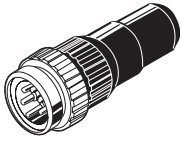

**Wiring**

| Terminal No. | Name           |
|--------------|----------------|
| 1            | DRAIN : NC     |
| 2            | V+ : NC        |
| 3            | V- : NC        |
| 4            | CAN H :  121 Ω |
| 5            | CAN L :  121 Ω |

**Note:** Terminating resistance (121 Ω) is connected between terminals 4 and 5.

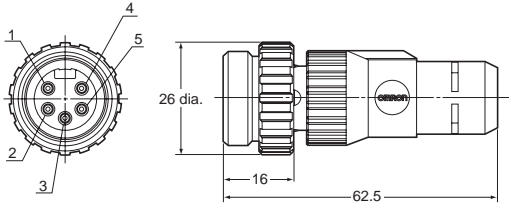

**Panel-mounting Connector (5 Pins for Communications)  
XS4M-D521-1**

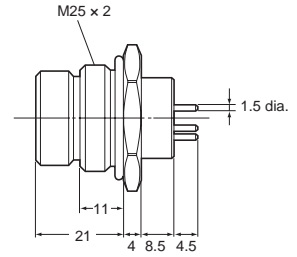
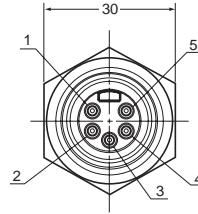

**Panel Cutout Dimensions**

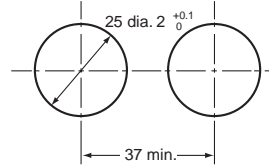

**PCB Processing Dimensions**

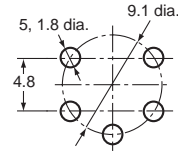

**Note:** A rubber seal and nut for panel mounting are included.

# I/O Peripheral Devices

## Applicable Connectors

### ● Assembly Connector Plugs for M12 Microconnectors

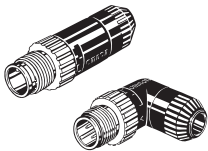
| Appearance  | Applicable cable diameter (mm) | Cable direction | Number of poles | Connection method |           |           |
|---|--------------------------------|-----------------|-----------------|-------------------|-----------|-----------|
|   |                                |                 |                 | Crimping          | Soldering | Screws    |
|  | For 6 dia. (5 to 6 dia.)       | Straight        | 4               | XS2G-D4C1         | XS2G-D421 | XS2G-D4S1 |
|   |                                | L-shaped        |                 | --                | XS2G-D422 | XS2G-D4S2 |
|   | For 5 dia. (4 to 5 dia.)       | Straight        |                 | XS2G-D4C3         | XS2G-D423 | XS2G-D4S3 |
|   |                                | L-shaped        |                 | --                | XS2G-D424 | XS2G-D4S4 |
|   | For 3 dia. (3 to 4 dia.)       | Straight        |                 | XS2G-D4C5         | XS2G-D425 | XS2G-D4S5 |
|   |                                | L-shaped        |                 | --                | XS2G-D426 | XS2G-D4S6 |
|   | For 7 dia. (6 to 7 dia.)       | Straight        |                 | --                | --        | XS2G-D4S9 |
|   | For 8 dia. (7 to 8 dia.)       |                 |                 | --                | --        | XS2G-D4S7 |

## Applicable Cables with Connectors



### ● Cables with Connector (Socket/Plug) on Both Ends (M12 Microconnectors for Power Supply and I/O)

| Appearance   | Cable direction   | Number of core wires | Cable length (m) | Standard cable  | Robot (earthquake-resistant) cable |
|--|-------------------|----------------------|------------------|-----------------|------------------------------------|
|  | Straight/Straight | 4                    | 1                | XS2W-D421-C81-A | XS2W-D421-C81-R                    |
|  |                   |                      | 2                | XS2W-D421-D81-A | XS2W-D421-D81-R                    |
|  |                   |                      | 5                | XS2W-D421-G81-A | XS2W-D421-G81-R                    |
|  | L-shaped/L-shaped |                      | 2                | XS2W-D422-D81-A | --                                 |
|  |                   |                      | 5                | XS2W-D422-G81-A |                                    |
|  |                   |                      | 2                | XS2W-D423-D81-A |                                    |
|  | Straight/L-shaped |                      | 5                | XS2W-D423-G81-A |                                    |
|  |                   |                      | 2                | XS2W-D424-D81-A |                                    |
|  | L-shaped/Straight |                      | 5                | XS2W-D424-G81-A |                                    |

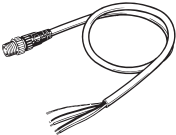
### ● Cables with connector plug on One End (M12 Microconnectors for I/O)

| Appearance  | Cable direction | Number of core wires | Cable length (m) | Standard cable  |
|---|-----------------|----------------------|------------------|-----------------|
|  | Straight        | 3                    | 0.3              | XS2H-D421-AC0-A |
|   |                 | 4                    |                  | XS2H-D421-A80-A |
|   |                 | 3                    | 1                | XS2H-D421-CC0-A |
|   |                 | 4                    |                  | XS2H-D421-C80-A |

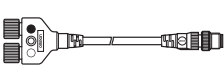
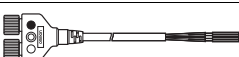
### ● Plugs and Sockets on Y-shaped Joints (M12 Microconnectors for I/O)

| Appearance  | Cable         | Connector               | DC models        |                 |
|---|---------------|-------------------------|------------------|-----------------|
|   |               |                         | Cable length (m) | Model           |
|  | With cable    | Connectors on both ends | 0.5              | XS2R-D426-B11-F |
|   |               |                         | 1                | XS2R-D426-C11-F |
|   |               |                         | 2                | XS2R-D426-D11-F |
|   |               |                         | 3                | XS2R-D426-E11-F |
|  |               | Connector on one end    | 2                | XS2R-D426-D10-F |
|   |               |                         | 5                | XS2R-D426-G10-F |
|  | Without cable | Connectors on both ends | --               | XS2R-D426-1     |

Note: Use is supported only for Environment-resistive Terminals (DRT2-□D16C(L)(-1)).







### ● Connector Cover for M12 Microconnectors

| Appearance  | Product                   | Model   | Application                        |
|---|---------------------------|---------|------------------------------------|
|  | Waterproof cover (socket) | XS2Z-22 | For covering unused I/O connectors |

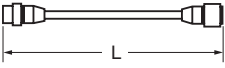
**Power Supply Peripheral Devices**

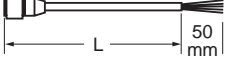
**Applicable Cables with Connectors**

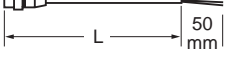
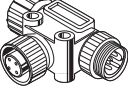
● Power Supply Connectors (7/8-16UN Miniconnectors)

| Appearance   | Product   | Cable length L (mm) | Model           |
|--|---|---------------------|-----------------|
|   |  | 1                   | XS4W-D421-101-A |
|  |   | 2                   | XS4W-D421-102-A |
|  |   | 5                   | XS4W-D421-105-A |
|  |   | 10                  | XS4W-D421-110-A |
|   |  | 1                   | XS4F-D421-101-A |
|  |   | 2                   | XS4F-D421-102-A |
|  |   | 5                   | XS4F-D421-105-A |
|  |   | 10                  | XS4F-D421-110-A |
|   |  | 1                   | XS4H-D421-101-A |
|  |   | 2                   | XS4H-D421-102-A |
|  |   | 5                   | XS4H-D421-105-A |
|  |   | 10                  | XS4H-D421-110-A |
|   | T-branch Connector  | --                  | XS4R-D424-5     |
|   | Panel mounting connector socket<br>Cable: 50 cm                                   | --                  | XS4P-D421-1C5-A |
|  | Panel mounting connector plug<br>DIP terminals                                    | --                  | XS4M-D421-1     |
| -  | Waterproofing Cap for Plug  | --                  | XS4Z-11         |
| -  | Waterproofing Cap for Socket  | --                  | XS4Z-12         |

## Read and Understand This Catalog

Please read and understand this catalog before purchasing the products. Please consult your OMRON representative if you have any questions or comments.

## Warranty and Limitations of Liability

### WARRANTY

OMRON's exclusive warranty is that the products are free from defects in materials and workmanship for a period of one year (or other period if specified) from date of sale by OMRON.

OMRON MAKES NO WARRANTY OR REPRESENTATION, EXPRESS OR IMPLIED, REGARDING NON-INFRINGEMENT, MERCHANTABILITY, OR FITNESS FOR PARTICULAR PURPOSE OF THE PRODUCTS. ANY BUYER OR USER ACKNOWLEDGES THAT THE BUYER OR USER ALONE HAS DETERMINED THAT THE PRODUCTS WILL SUITABLY MEET THE REQUIREMENTS OF THEIR INTENDED USE. OMRON DISCLAIMS ALL OTHER WARRANTIES, EXPRESS OR IMPLIED.

### LIMITATIONS OF LIABILITY

OMRON SHALL NOT BE RESPONSIBLE FOR SPECIAL, INDIRECT, OR CONSEQUENTIAL DAMAGES, LOSS OF PROFITS OR COMMERCIAL LOSS IN ANY WAY CONNECTED WITH THE PRODUCTS, WHETHER SUCH CLAIM IS BASED ON CONTRACT, WARRANTY, NEGLIGENCE, OR STRICT LIABILITY.

In no event shall the responsibility of OMRON for any act exceed the individual price of the product on which liability is asserted.

IN NO EVENT SHALL OMRON BE RESPONSIBLE FOR WARRANTY, REPAIR, OR OTHER CLAIMS REGARDING THE PRODUCTS UNLESS OMRON'S ANALYSIS CONFIRMS THAT THE PRODUCTS WERE PROPERLY HANDLED, STORED, INSTALLED, AND MAINTAINED AND NOT SUBJECT TO CONTAMINATION, ABUSE, MISUSE, OR INAPPROPRIATE MODIFICATION OR REPAIR.

## Application Considerations

### SUITABILITY FOR USE

OMRON shall not be responsible for conformity with any standards, codes, or regulations that apply to the combination of products in the customer's application or use of the products.

At the customer's request, OMRON will provide applicable third party certification documents identifying ratings and limitations of use that apply to the products. This information by itself is not sufficient for a complete determination of the suitability of the products in combination with the end product, machine, system, or other application or use.

The following are some examples of applications for which particular attention must be given. This is not intended to be an exhaustive list of all possible uses of the products, nor is it intended to imply that the uses listed may be suitable for the products:

- Outdoor use, uses involving potential chemical contamination or electrical interference, or conditions or uses not described in this catalog.
- Nuclear energy control systems, combustion systems, railroad systems, aviation systems, medical equipment, amusement machines, vehicles, safety equipment, and installations subject to separate industry or government regulations.
- Systems, machines, and equipment that could present a risk to life or property.

Please know and observe all prohibitions of use applicable to the products.

NEVER USE THE PRODUCTS FOR AN APPLICATION INVOLVING SERIOUS RISK TO LIFE OR PROPERTY WITHOUT ENSURING THAT THE SYSTEM AS A WHOLE HAS BEEN DESIGNED TO ADDRESS THE RISKS, AND THAT THE OMRON PRODUCTS ARE PROPERLY RATED AND INSTALLED FOR THE INTENDED USE WITHIN THE OVERALL EQUIPMENT OR SYSTEM.

### PROGRAMMABLE PRODUCTS

OMRON shall not be responsible for the user's programming of a programmable product, or any consequence thereof.

## Disclaimers

### CHANGE IN SPECIFICATIONS

Product specifications and accessories may be changed at any time based on improvements and other reasons.

It is our practice to change model numbers when published ratings or features are changed, or when significant construction changes are made. However, some specifications of the products may be changed without any notice. When in doubt, special model numbers may be assigned to fix or establish key specifications for your application on your request. Please consult with your OMRON representative at any time to confirm actual specifications of purchased products.

### DIMENSIONS AND WEIGHTS

Dimensions and weights are nominal and are not to be used for manufacturing purposes, even when tolerances are shown.

### PERFORMANCE DATA

Performance data given in this catalog is provided as a guide for the user in determining suitability and does not constitute a warranty. It may represent the result of OMRON's test conditions, and the users must correlate it to actual application requirements. Actual performance is subject to the OMRON Warranty and Limitations of Liability.

### ERRORS AND OMISSIONS

The information in this document has been carefully checked and is believed to be accurate; however, no responsibility is assumed for clerical, typographical, or proofreading errors, or omissions.

2011.8

In the interest of product improvement, specifications are subject to change without notice.

**OMRON Corporation**  
Industrial Automation Company

<http://www.ia.omron.com/>

(c)Copyright OMRON Corporation 2011 All Right Reserved.