

Guard Lock Safety-door Switch D4JL

CSM_D4JL_DS_E_4_1

World's Top* Holding Force of 3,000 N

*For plastic models, as of May 2008

- Two safety circuits and two monitor contacts provide an array of monitoring patterns.
- Standard gold-clad contacts enable use with ordinary loads and microloads.
- Models with trapped keys prevent workers from being locked in hazardous work areas.
- Models with rear release buttons allow people to unlock the Switch and escape if they are locked into hazardous areas.
- IP67 degree of protection



Be sure to read the "Safety Precautions" on page 21 and the "Precautions for All Safety Door Switches".

Features

Plastic Guard Lock Safety-door Switches Rank Among the Strongest in the World

A holding force of 3,000 N makes these Switches suitable for large, heavy doors.



Models with Trapped Keys

(See page 5 for a list of models.)

OMRON also offers Trapped Key Switches (on mechanical lock models only).

As long as a person has the trapped key when he enters a hazardous area, he does not have to worry about somebody locking the door and trapping him inside.

The door can be opened only by supplying power to the solenoid and then turning the trapped key to unlock the D4JL.

There are thirty different types of trapped keys available for use in applications with adjacent hazardous areas.

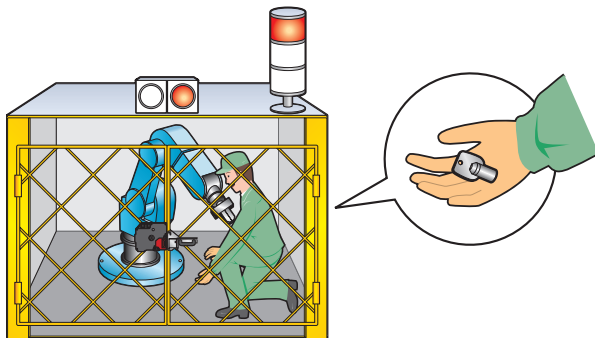

Two Safety Circuits and Two Monitor Contacts

The D4JL has two safety circuits. It also has two contacts to separately monitor the open/closed status of the door and the status of the lock.

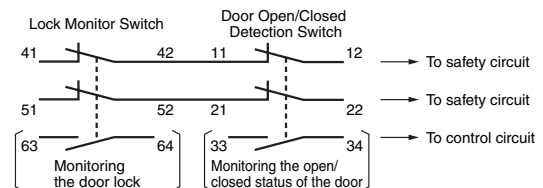

Models with Rear Release Buttons

(See page 4 for a list of models.)

A Switch with a rear release button allows the door to be unlocked from inside a hazardous area in an emergency. OMRON also offers Switches with Special Slide Keys. Refer to the "D4NS-SK/D4JL-SK" for details.

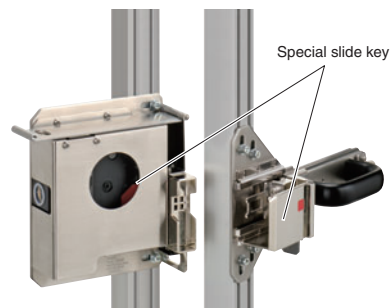
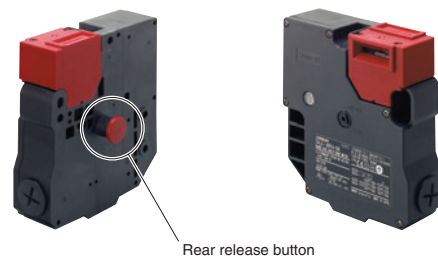

Model Number Structure

Model Number Legend

Switches

D4JL-□□□□-□□-□□
 1 2 3 4 5 6 7

1. Conduit Size

- 1: Pg13.5
- 2: G1/2
- 3: 1/2-14NPT *1
- 4: M20

2. Built-in Switch

- N: 2NC/1NO + 2NC/1NO (slow-action contacts)
- P: 2NC/1NO + 3NC (slow-action contacts)
- Q: 3NC + 2NC/1NO (slow-action contacts)
- R: 3NC + 3NC (slow-action contacts)

3. Head Material

- F: Plastic

4. Door Lock and Release

- A: Mechanical lock/24 VDC solenoid release
- G: 24 VDC Solenoid lock/Mechanical release

5. Indicator

- C: 24 VDC (green LED indicator)
- D: 24 VDC (orange LED indicator)

6. Release Key Type

- 5: Special release key *2
- 6: Special release key + rear release button *2
- 7: Trapped key

7. Trapped Key Type

- 01 to 30: 30 types *3

Note: A 24 VDC solenoid lock cannot be combined with a trapped key.

A 24 VDC solenoid lock cannot be combined with a special release key and rear release button.

*1. Models with M20 conduits come with an M20 to 1/2-14NPT Adaptor.

*2. Release keys are provided.

*3. Thirty types of trapped keys can be manufactured. Specify the trapped key type in numerical order starting from 01 when ordering.

Switches (Connector type)

D4JL-2RFA-D5N-X
 1 2 3 4 5 6 7 8

1. Conduit Size

- 2: G1/2

2. Built-in Switch

- R: 3NC + 3NC (slow-action contacts)

3. Head Material

- F: Plastic

4. Door Lock and Release

- A: Mechanical lock/24 VDC solenoid release

Operation Keys

D4JL-K□
 1

1. Operation Key Type

- 1: Horizontal mounting
- 2: Vertical mounting
- 3: Adjustable mounting (horizontal)

5. Indicator

- C: 24 VDC (green LED indicator)
- D: 24 VDC (orange LED indicator)

6. Release Key Type

- 5: Standard release key

7. Connection Method

- N: Connector type

8. Cover Mounting Screws

- T: Standard screws
- X: Special screws

Note: For more information about connector types, contact your OMRON sales representative.

Ordering Information

Switches (Operation Keys are sold separately.)

Consult with your OMRON representative when ordering any models that are not listed in this table.

Standard Models

■ : Models with certified direct opening contacts.

Release key type	Indicator	Lock and release types	Contact configuration (door open/closed detection switch and lock monitor switch contacts)	Conduit opening	Model
Special release key	Green	Mechanical lock Solenoid release	2NC/1NO+2NC/1NO	PG13.5	D4JL-1NFA-C5
				G1/2	D4JL-2NFA-C5
				1/2-14NPT	D4JL-3NFA-C5
				M20	D4JL-4NFA-C5
			2NC/1NO+3NC	PG13.5	D4JL-1PFA-C5
				G1/2	D4JL-2PFA-C5
				1/2-14NPT	D4JL-3PFA-C5
				M20	D4JL-4PFA-C5
			3NC+2NC/1NO	PG13.5	D4JL-1QFA-C5
				G1/2	D4JL-2QFA-C5
				1/2-14NPT	D4JL-3QFA-C5
				M20	D4JL-4QFA-C5
		3NC+3NC	PG13.5	D4JL-1RFA-C5	
			G1/2	D4JL-2RFA-C5	
			1/2-14NPT	D4JL-3RFA-C5	
			M20	D4JL-4RFA-C5	
		Solenoid lock Mechanical release	2NC/1NO+2NC/1NO	PG13.5	D4JL-1NFG-C5
				G1/2	D4JL-2NFG-C5
				1/2-14NPT	D4JL-3NFG-C5
				M20	D4JL-4NFG-C5
			2NC/1NO+3NC	PG13.5	D4JL-1PFG-C5
				G1/2	D4JL-2PFG-C5
				1/2-14NPT	D4JL-3PFG-C5
				M20	D4JL-4PFG-C5
	3NC+2NC/1NO		PG13.5	D4JL-1QFG-C5	
			G1/2	D4JL-2QFG-C5	
			1/2-14NPT	D4JL-3QFG-C5	
			M20	D4JL-4QFG-C5	
	3NC+3NC	PG13.5	D4JL-1RFG-C5		
		G1/2	D4JL-2RFG-C5		
		1/2-14NPT	D4JL-3RFG-C5		
		M20	D4JL-4RFG-C5		
	Orange	Mechanical lock Solenoid release	2NC/1NO+2NC/1NO	PG13.5	D4JL-1NFA-D5
				G1/2	D4JL-2NFA-D5
				1/2-14NPT	D4JL-3NFA-D5
				M20	D4JL-4NFA-D5
			2NC/1NO+3NC	PG13.5	D4JL-1PFA-D5
				G1/2	D4JL-2PFA-D5
				1/2-14NPT	D4JL-3PFA-D5
				M20	D4JL-4PFA-D5
			3NC+2NC/1NO	PG13.5	D4JL-1QFA-D5
				G1/2	D4JL-2QFA-D5
				1/2-14NPT	D4JL-3QFA-D5
				M20	D4JL-4QFA-D5
		3NC+3NC	PG13.5	D4JL-1RFA-D5	
			G1/2	D4JL-2RFA-D5	
			1/2-14NPT	D4JL-3RFA-D5	
			M20	D4JL-4RFA-D5	
Solenoid lock Mechanical release		2NC/1NO+2NC/1NO	PG13.5	D4JL-1NFG-D5	
			G1/2	D4JL-2NFG-D5	
			1/2-14NPT	D4JL-3NFG-D5	
			M20	D4JL-4NFG-D5	
		2NC/1NO+3NC	PG13.5	D4JL-1PFG-D5	
			G1/2	D4JL-2PFG-D5	
			1/2-14NPT	D4JL-3PFG-D5	
			M20	D4JL-4PFG-D5	
	3NC+2NC/1NO	PG13.5	D4JL-1QFG-D5		
		G1/2	D4JL-2QFG-D5		
		1/2-14NPT	D4JL-3QFG-D5		
		M20	D4JL-4QFG-D5		
3NC+3NC	PG13.5	D4JL-1RFG-D5			
	G1/2	D4JL-2RFG-D5			
	1/2-14NPT	D4JL-3RFG-D5			
	M20	D4JL-4RFG-D5			

Models with Rear Release Buttons

 : Models with certified direct opening contacts.

Release key type	Indicator	Lock and release types	Contact configuration (door open/closed detection switch and lock monitor switch contacts)	Conduit opening	Model
Special release key	Green	Mechanical lock Solenoid release	2NC/1NO+2NC/1NO	PG13.5	D4JL-1NFA-C6
				G1/2	D4JL-2NFA-C6
				1/2-14NPT	D4JL-3NFA-C6
				M20	D4JL-4NFA-C6
			2NC/1NO+3NC	PG13.5	D4JL-1PFA-C6
				G1/2	D4JL-2PFA-C6
				1/2-14NPT	D4JL-3PFA-C6
				M20	D4JL-4PFA-C6
			3NC+2NC/1NO	PG13.5	D4JL-1QFA-C6
				G1/2	D4JL-2QFA-C6
				1/2-14NPT	D4JL-3QFA-C6
				M20	D4JL-4QFA-C6
	3NC+3NC		PG13.5	D4JL-1RFA-C6	
			G1/2	D4JL-2RFA-C6	
			1/2-14NPT	D4JL-3RFA-C6	
			M20	D4JL-4RFA-C6	
	Orange		2NC/1NO+2NC/1NO	PG13.5	D4JL-1NFA-D6
				G1/2	D4JL-2NFA-D6
				1/2-14NPT	D4JL-3NFA-D6
				M20	D4JL-4NFA-D6
			2NC/1NO+3NC	PG13.5	D4JL-1PFA-D6
				G1/2	D4JL-2PFA-D6
				1/2-14NPT	D4JL-3PFA-D6
				M20	D4JL-4PFA-D6
3NC+2NC/1NO		PG13.5	D4JL-1QFA-D6		
		G1/2	D4JL-2QFA-D6		
		1/2-14NPT	D4JL-3QFA-D6		
		M20	D4JL-4QFA-D6		
3NC+3NC	PG13.5	D4JL-1RFA-D6			
	G1/2	D4JL-2RFA-D6			
	1/2-14NPT	D4JL-3RFA-D6			
	M20	D4JL-4RFA-D6			

Models with Trapped Keys

■ : Models with certified direct opening contacts.



Release key type	Indicator	Lock and release types	Contact configuration (door open/closed detection switch and lock monitor switch contacts)	Conduit opening	Model	
Trapped key #1	Green	Mechanical lock Solenoid release	2NC/1NO+2NC/1NO	PG13.5	D4JL-1NFA-C7-01	
				G1/2	D4JL-2NFA-C7-01	
				1/2-14NPT	D4JL-3NFA-C7-01	
				M20	D4JL-4NFA-C7-01	
			2NC/1NO+3NC	PG13.5	D4JL-1PFFA-C7-01	
				G1/2	D4JL-2PFFA-C7-01	
				1/2-14NPT	D4JL-3PFFA-C7-01	
				M20	D4JL-4PFFA-C7-01	
			3NC+2NC/1NO	PG13.5	D4JL-1QFA-C7-01	
				G1/2	D4JL-2QFA-C7-01	
				1/2-14NPT	D4JL-3QFA-C7-01	
				M20	D4JL-4QFA-C7-01	
	3NC+3NC	PG13.5	D4JL-1RFA-C7-01			
		G1/2	D4JL-2RFA-C7-01			
		1/2-14NPT	D4JL-3RFA-C7-01			
		M20	D4JL-4RFA-C7-01			
	Orange			2NC/1NO+2NC/1NO	PG13.5	D4JL-1NFA-D7-01
					G1/2	D4JL-2NFA-D7-01 #2
					1/2-14NPT	D4JL-3NFA-D7-01
					M20	D4JL-4NFA-D7-01
				2NC/1NO+3NC	PG13.5	D4JL-1PFFA-D7-01
					G1/2	D4JL-2PFFA-D7-01 #2
					1/2-14NPT	D4JL-3PFFA-D7-01
					M20	D4JL-4PFFA-D7-01
3NC+2NC/1NO				PG13.5	D4JL-1QFA-D7-01	
				G1/2	D4JL-2QFA-D7-01 #2	
				1/2-14NPT	D4JL-3QFA-D7-01	
				M20	D4JL-4QFA-D7-01	
3NC+3NC	PG13.5	D4JL-1RFA-D7-01				
	G1/2	D4JL-2RFA-D7-01 #2				
	1/2-14NPT	D4JL-3RFA-D7-01				
	M20	D4JL-4RFA-D7-01				

*1. Thirty types of trapped keys can be manufactured. Specify the trapped key type in numerical order starting from 01 when ordering.

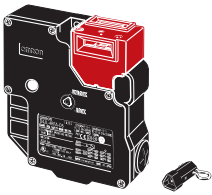
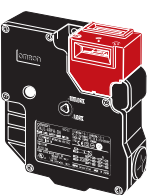
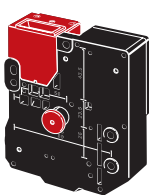
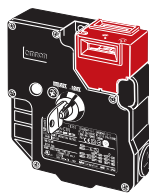
*2. Models with Korean S-mark certification.

Release key position	Front	Front and rear release button	Front
Release key type	Special release key	Special release key	Trapped key
Switch appearance		<div style="display: flex; justify-content: space-around;"> <div style="text-align: center;"> <p>Front</p>  </div> <div style="text-align: center;"> <p>Rear</p>  </div> </div>	

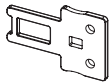
Operation Keys

Type	Model
Horizontal mounting 	D4JL-K1
Vertical mounting 	D4JL-K2

Type	Model
Adjustable mounting (horizontal) 	D4JL-K3

Specifications

Standards and EC Directives

Conforms to the following EC Directives:

- Machinery Directive
- Low Voltage Directive
- EN 1088
- EN 60204-1
- GS-ET-19
- CCC

Certified Standards

Certification body	Standard	File No.
TÜV SÜD	EN 60947-5-1 (certified direct opening)	Consult your OMRON representative for details.
UL *1	UL 508, CSA C22.2 No. 14	
CQC (CCC)	GB14048.5	2005010305167533
KOSHA *2	EN60947-5-1	2005-196

*1. CSA C22.2 No. 14 was certified by UL.

*2. Only certain models have been certified.

Certified Standard Ratings

TÜV (EN 60947-5-1)

Item	Utilization category	AC-15	DC-13
Rated operating current (Ie)		3 A	0.27 A
Rated operating voltage (Ue)		240 V	250 V

Note: Use a 10 A fuse type gI or gG that conforms to IEC60269 as a short-circuit protection device. This fuse is not built into the Switch.

UL/CSA (UL 508, CSA C22.2 No. 14)

A300

Rated voltage	Carry current	Current (A)		Volt-amperes (VA)	
		Make	Break	Make	Break
120 VAC	10 A	60	6	7,200	720
240 VAC		30	3		

Q300

Rated voltage	Carry current	Current (A)		Volt-amperes (VA)	
		Make	Break	Make	Break
125 VDC	2.5 A	0.55	0.55	69	69
250 VDC		0.27	0.27		

Solenoid Coil Characteristics

Item	Type	24 VDC
Rated operating voltage (100% ED)		24 VDC ^{+10%} _{-15%}
Current consumption		Approx. 200 mA
Insulation Class		Class F (130°C max.)

Indicator Characteristics

Item	Type	LED	
Rated voltage		24 VDC	24 VDC
Current consumption		Approx. 1 mA	Approx. 8 mA
Color (LED)		Orange	Green

Characteristics

Degree of protection *1		IP67 (EN60947-5-1)
Durability *2	Mechanical	1,000,000 operations min. (trapped key: 10,000 operations min., rear release button: 3,000 operations min.)
	Electrical	500,000 operations min. (3 A resistive load at 250 VAC) *3
Operating speed		0.05 to 0.5 m/s
Operating frequency		30 operations/minute max.
Direct opening force *4		60 N min. (EN60947-5-1)
Direct opening travel *4		15 mm min. (EN60947-5-1)
Holding force *5		3,000 N min.
Contact resistance		25 mΩ max. (per contact)
Minimum applicable load *6		1 mA resistive load at 5 VDC (N-level reference value)
Rated insulation voltage (U_i)		300 V (EN60947-5-1)
Rated frequency		50/60 Hz
Protection against electric shock		Class II (double insulation)
Pollution degree (operating environment)		3 (EN60947-5-1)
Impulse withstand voltage (EN60947-5-1)	Between terminals of same polarity	2.5 kV
	Between terminals of different polarity	4 kV
	Between other terminals and non-current carrying metallic parts	6 kV
Insulation resistance		100 MΩ min. (at 500 VDC)
Contact gap		2 × 2 mm min.
Vibration resistance	Malfunction	10 to 55 Hz, 0.75 mm single amplitude
	Destruction	1,000 m/s ² min.
Shock resistance	Malfunction	80 m/s ² min.
	Malfunction	80 m/s ² min.
Conditional short-circuit current		100 A (EN60947-5-1) *7
Conventional free air thermal current (I_{th})		10 A (between terminals 12 and 41), 3 A (between all other terminals) (EN60947-5-1)
Ambient operating temperature		-10 to +55°C (with no icing)
Ambient operating humidity		95% max.
Weight		Approx. 650 g (D4JL-4NFA-C7-01)

Note: The above values are initial values.

*1. The degree of protection is tested using the method specified by the standard (EN60947-5-1). Confirm that sealing properties are sufficient for the operating conditions and environment beforehand. Although the switch box is protected from dust or water penetration, do not use the D4JL in places where foreign material may enter through the key hole on the head, otherwise Switch damage or malfunctioning may occur.

*2. The durability is for an ambient temperature of 5 to 35°C and an ambient humidity of 40% to 70%. For further conditions, consult your OMRON sales representative.

*3. Do not pass a 3 A, 250 VAC load through more than two circuits.

*4. These figures are minimum requirements for safe operation.

*5. This figure is based on the GS-ET-19 evaluation method.

*6. This value will vary with the switching frequency, environment, and reliability level. Confirm that correct operation is possible with the actual load beforehand.

*7. Use a 10 A fuse type gI or gG that conforms to IEC 60269 as a short-circuit protection device.

Connections

Internal Circuit Diagram Indicator

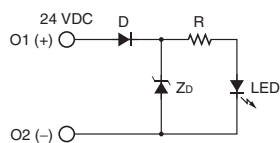

Solenoid

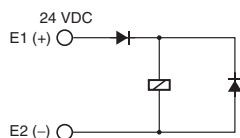

Circuit Connection Example

(Examples for the D4JL-□NF□-□)

- Terminals 11-42 and terminals 21-52 are connected internally and so connect terminals 12-41 and 22-51 for safety-circuit input (GS-ET-19).

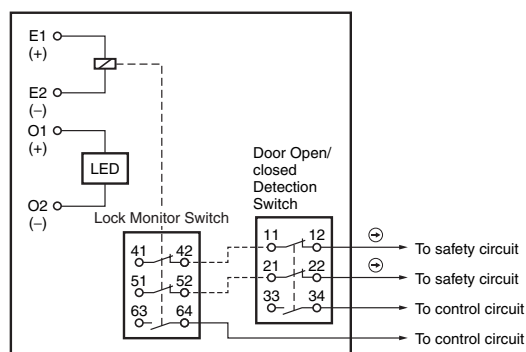

- Direct opening contacts used as safety-circuit input are indicated with the \ominus mark.
Terminals 11-12 and terminals 21-22 are direct opening contacts.
- Do not connect the indicator directly to direct opening contacts. If indicator is connected in parallel with direct opening contacts, a short-circuit current may flow in the event that the indicator is damaged, causing equipment to malfunction.
- Do not switch standard loads for more than 2 circuits. Otherwise, the level of insulation may decrease.
- The solenoid terminals have polarity (E1: + and E2: -). Confirm the polarity before wiring.

Operation Method

Operation Principles Mechanical Lock Models

Operation Key removed.

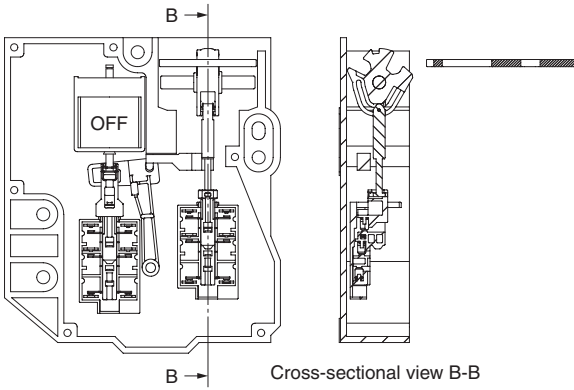

Operation Key inserted: Door locked.

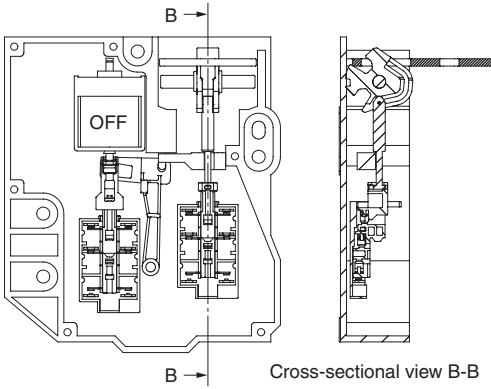

Solenoid ON: Door unlocked.

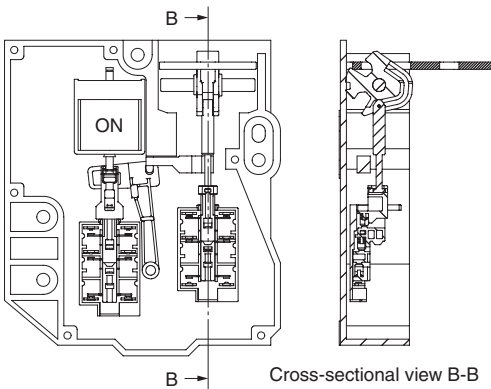

Solenoid Lock Models

Operation Key removed.

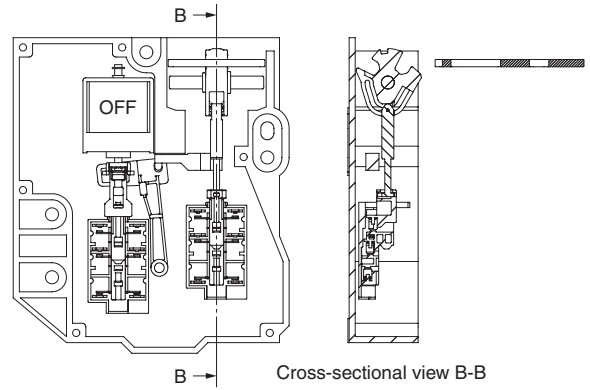

Operation Key inserted: Door unlocked.

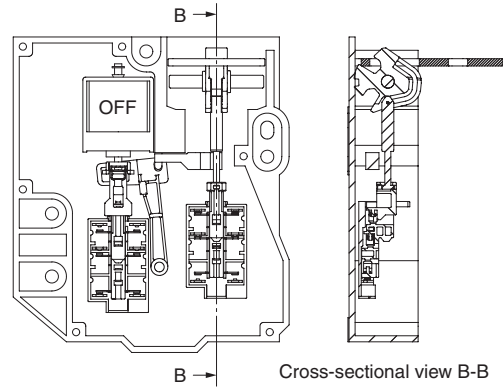

Solenoid ON: Door locked.

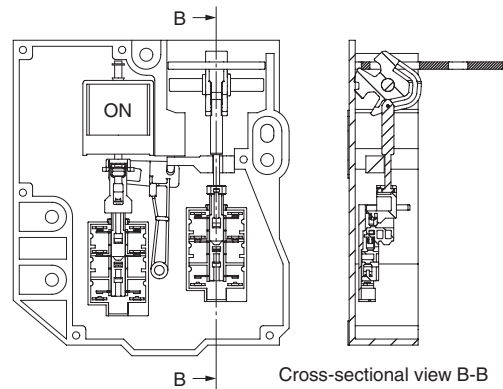

Trapped Key Models

(1) Operation Key removed, solenoid OFF, and trapped key removed.

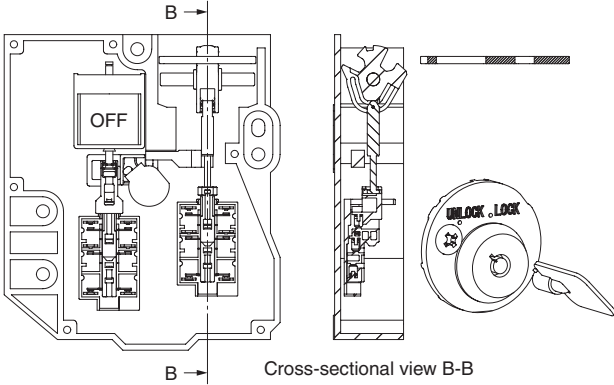

(4) Operation Key inserted, solenoid ON, and trapped key inserted.
Status: Door locked and trapped key can be removed.

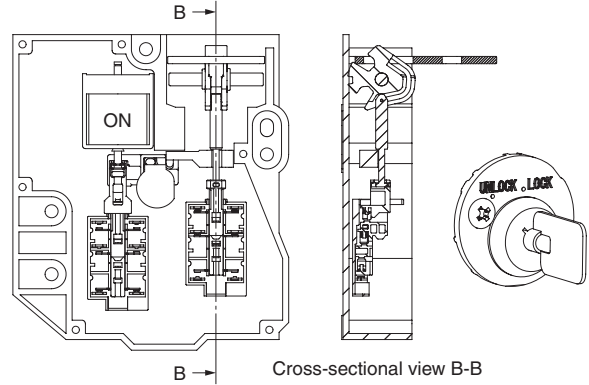

(2) Operation Key inserted, solenoid OFF, and trapped key removed. Status: Door unlocked.

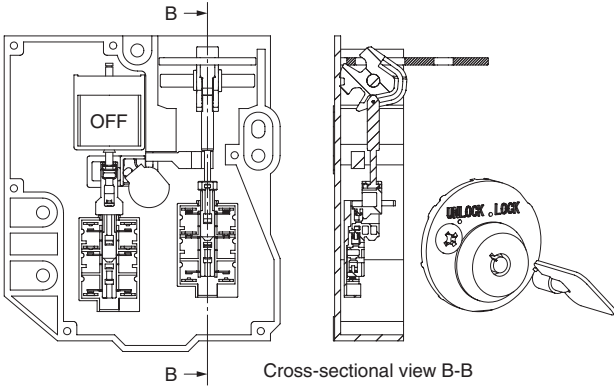

(5) Operation Key inserted, solenoid ON, and trapped key removed. Status: Door unlocked.

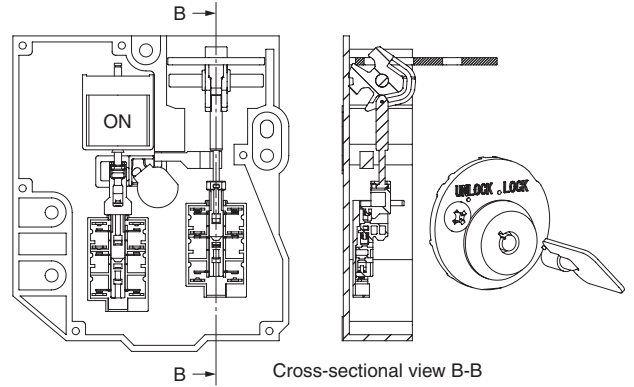

(3) Operation Key inserted, solenoid OFF, and trapped key inserted. Status: Door locked and trapped key cannot be removed.

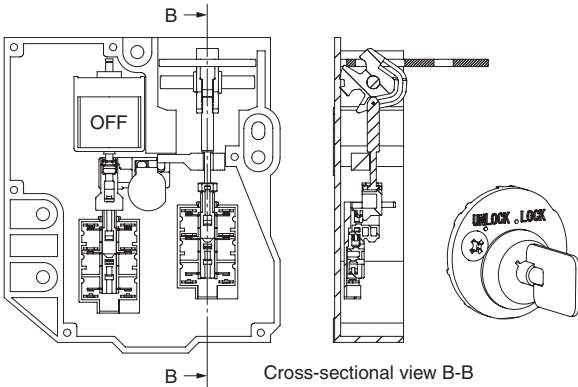

(6) Operation Key removed, solenoid ON, and trapped key removed.

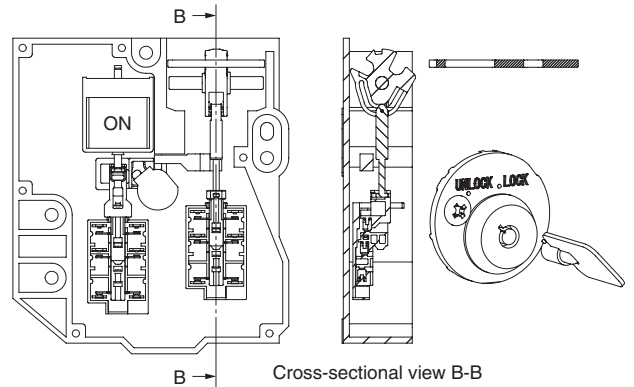

Structure and Nomenclature

Structure (D4JL-□□□A-□5 and D4JL-□□□G-□5)

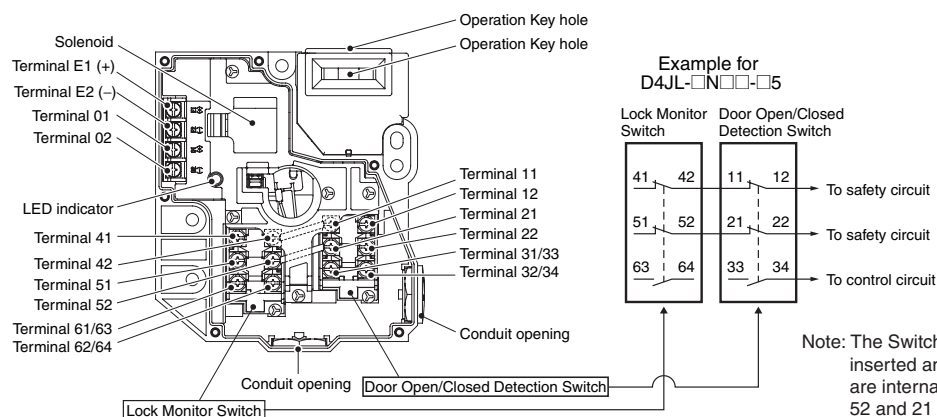

Contact Forms

Indicates conditions where the Key is inserted and the lock is applied. Terminals 42-11 and terminals 52-21 are connected internally (as per BIA GS-ET-19).

Model	Contact (door open/closed detection and lock monitor)	Contact form		Operating pattern	Remarks
		Lock monitor	Door open/closed detection		
D4JL-□NF□-□	2NC/1NO+2NC/1NO				NC contacts 11-12 and 21-22 have a certified direct opening mechanism (⊖). The terminals 41-12, 51-22, 33-34, and 63-64 can be used as unlike poles.
D4JL-□PF□-□	2NC/1NO+3NC				NC contacts 11-12 and 21-22 have a certified direct opening mechanism (⊖). The terminals 41-12, 51-22, 33-34, and 61-62 can be used as unlike poles.
D4JL-□QF□-□	3NC+2NC/1NO				NC contacts 11-12, 21-22 and 31-32 have a certified direct opening mechanism (⊖). The terminals 41-12, 51-22, 31-32, and 63-64 can be used as unlike poles.
D4JL-□RF□-□	3NC+3NC				NC contacts 11-12, 21-22, and 31-32 have a certified direct opening mechanism (⊖). The terminals 41-12, 51-22, 31-32, and 61-62 can be used as unlike poles.

Operating Cycle

Structure (D4JL-□□□A-□5 and D4JL-□□□G-□5)

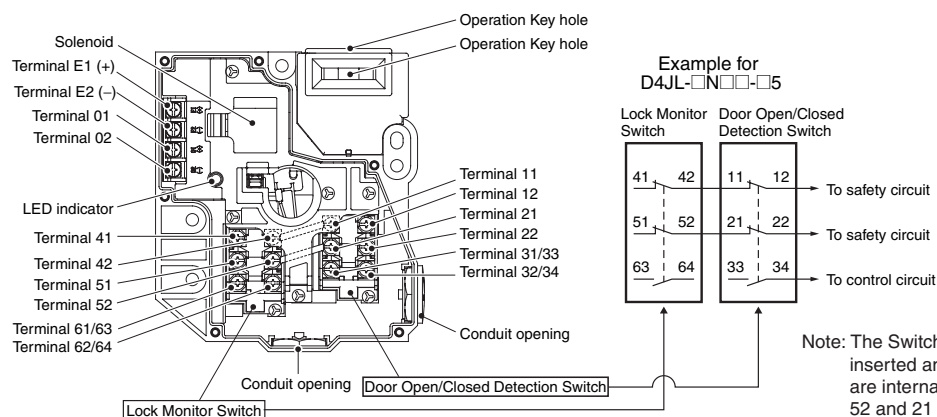

Operating Cycle Examples (for Standard Models)

D4JL-□□□A-□5 (Mechanical Lock Models with Special Release Keys)

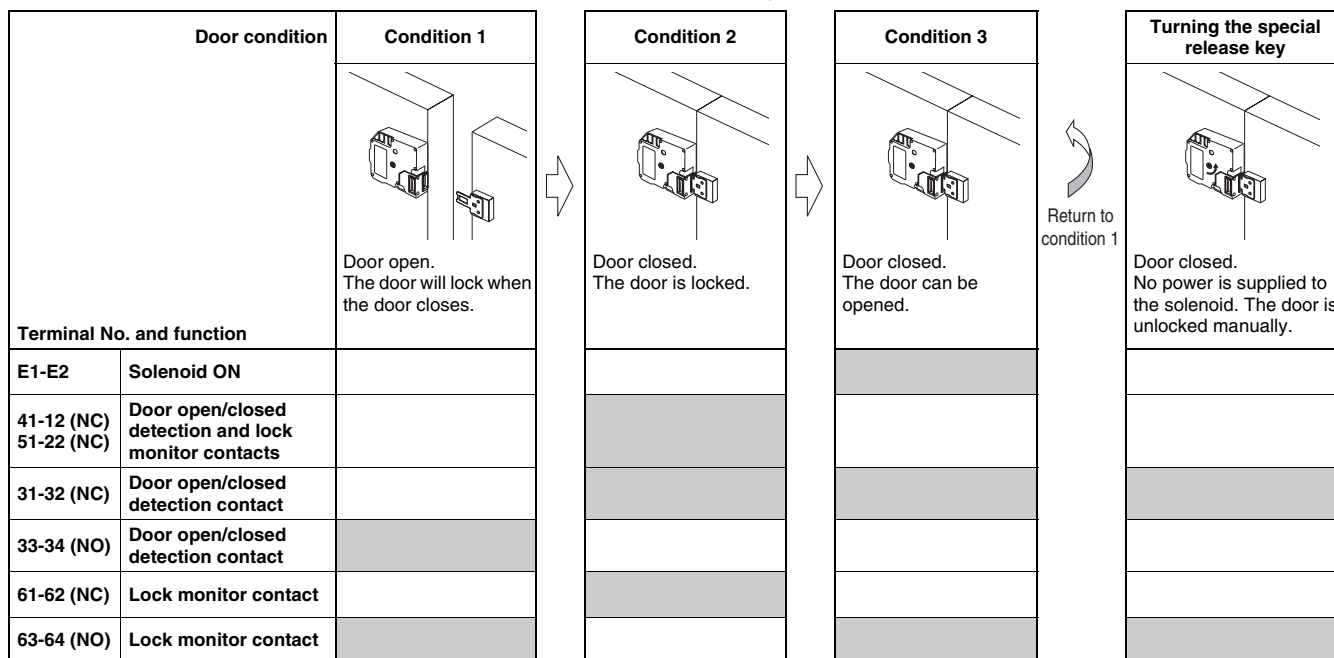

D4JL-□□□G-□5 (Solenoid Lock Models with Special Release Keys)

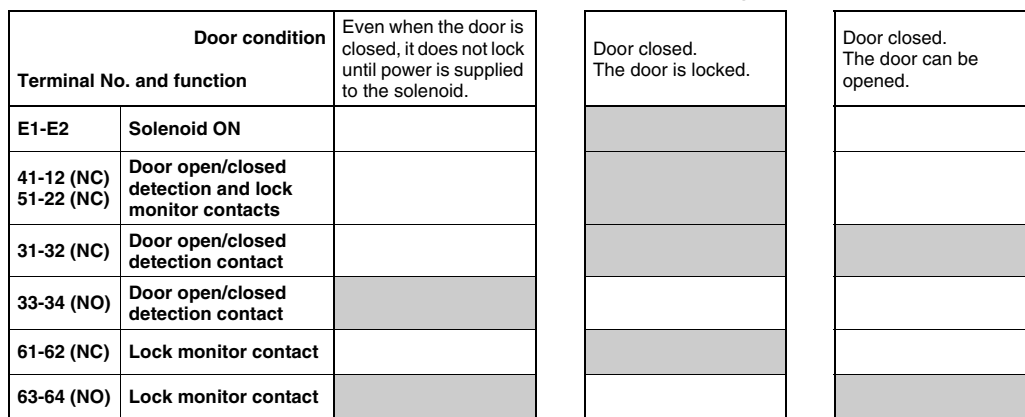

The shaded areas indicate the contact is closed and power is supplied to the solenoid.

- Door open/closed detection and lock monitor contacts: Can be used in safety circuits because of the direct opening mechanisms.
- Door open/closed detection contact: Can be used to confirm whether the key is inserted and to monitor the open/closed status of a door.
- Lock monitor contact: Can be used to confirm whether power is supplied to the solenoid and to monitor whether or not a door can be opened or closed.

Note: The door open/closed detection and lock monitor contact configuration depends on the model.

Structure (D4JL-□□□A-□6)

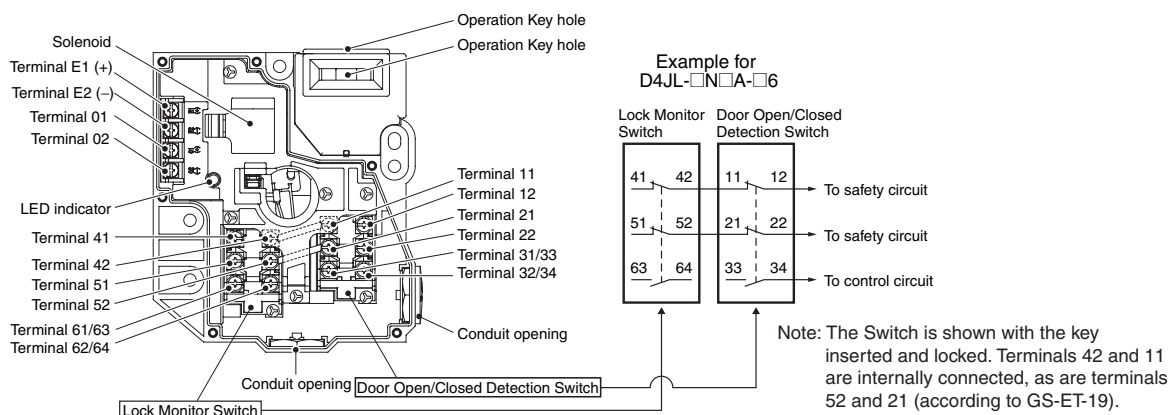

Operating Cycle Examples (for Models with Rear Release Buttons)

D4JL-□□□A-□6 (Mechanical Lock Models with Special Release Keys and Rear Release Buttons)

Door condition	Condition 1	Condition 2	Condition 3	Turning the special release key	Pressing the rear release button
	<p>Door open. The door will lock when the door closes.</p>	<p>Door closed. The door is locked.</p>	<p>Door closed. The door can be opened.</p>	<p>Door closed. No power is supplied to the solenoid. The door is unlocked manually.</p>	<p>Door closed. No power is supplied to the solenoid. The door is unlocked manually.</p>
Terminal No. and function					
E1-E2	Solenoid ON				
41-12 (NC) 51-22 (NC)	Door open/closed detection and lock monitor contacts				
31-32 (NC)	Door open/closed detection contact				
33-34 (NO)	Door open/closed detection contact				
61-62 (NC)	Lock monitor contact				
63-64 (NO)	Lock monitor contact				

The shaded areas indicate the contact is closed and power is supplied to the solenoid.

Door open/closed detection and lock monitor contacts: Can be used in safety circuits because of the direct opening mechanisms.

Door open/closed detection contact:

Can be used to confirm whether the key is inserted and to monitor the open/closed status of a door.

Lock monitor contact:

Can be used to confirm whether power is supplied to the solenoid and to monitor whether or not a door can be opened or closed.

Note: The door open/closed detection and lock monitor contact configuration depends on the model.

Structure (D4JL-□□□A-□7-□□)

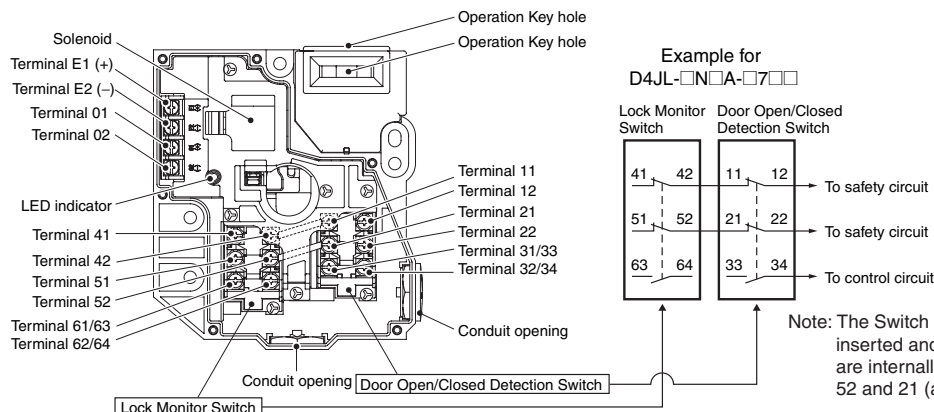

Operating Cycle Examples (for Models with Trapped Keys)

D4JL-□□□A-□7□□ (Models with Trapped Keys)

Door condition	Condition 1	Condition 2	Condition 3	Condition 4	Condition 5	Condition 6
	Door open. The Key is not inserted. The door will not lock when the door closes.	Door closed. The Key is not inserted. The door is not locked.	Door closed. The Key is inserted. The door is locked.	Door closed. The Key is inserted. The door remains locked.	Door closed. The Key is not inserted. The door can be opened.	Door open. The Key is not inserted. The door will not lock when the door closes.
Terminal No. and function						
E1-E2	Solenoid ON					
41-12 (NC) 51-22 (NC)	Door open/closed detection and lock monitor contacts					
31-32 (NC)	Door open/closed detection contact					
33-34 (NO)	Door open/closed detection contact					
61-62 (NC)	Lock monitor contact					
63-64 (NO)	Lock monitor contact					

Return to condition 1

The shaded areas indicate the contact is closed and power is supplied to the solenoid.

Door open/closed detection and lock monitor contacts: Can be used in safety circuits because of the direct opening mechanisms.

Door open/closed detection contact:

Can be used to confirm whether the key is inserted and to monitor the open/closed status of a door.

Lock monitor contact:

Can be used to confirm whether power is supplied to the solenoid and to monitor whether or not a key can be removed.

Note: 1. Door open/closed detection and lock monitor contact configuration depends on the model.

2. If power is supplied to the solenoid, the door cannot be unlocked until the Key is turned to the left and removed. The Key cannot be removed unless it is in the UNLOCK position.

Dimensions

Dimensions and Operating Characteristics

Switches

D4JL-□□F□-C5

D4JL-□□F□-D5

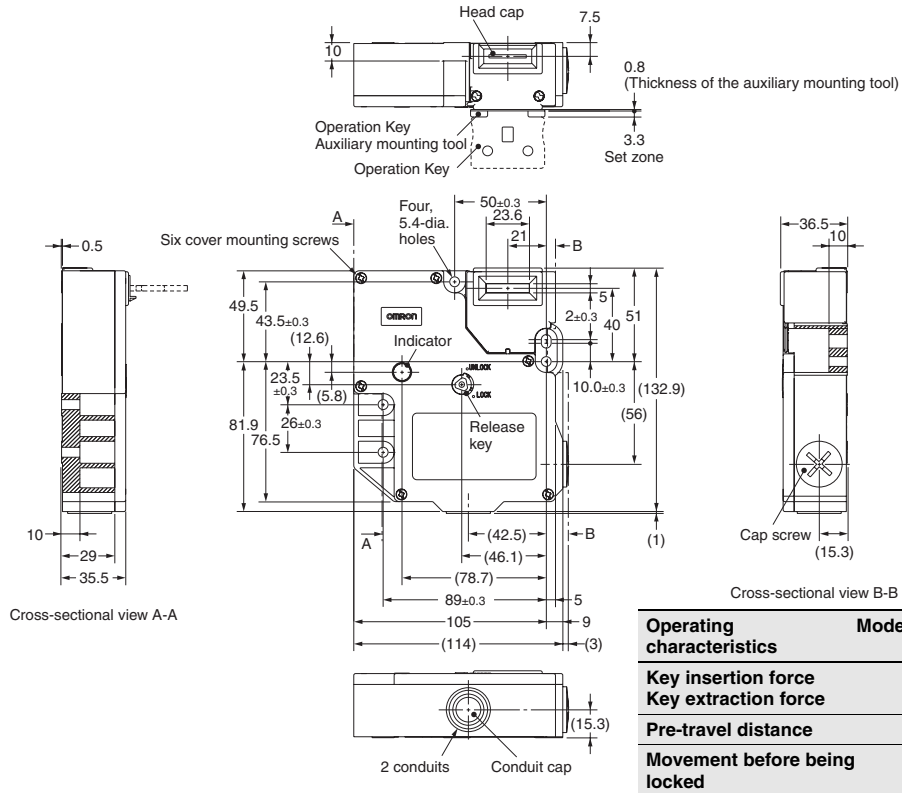
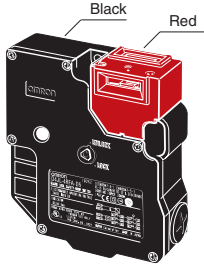

Operating characteristics	Model	D4JL-□□F□-C5 D4JL-□□F□-D5
Key insertion force		20 N max.
Key extraction force		Approx. 6 N
Pre-travel distance		14 mm max.
Movement before being locked		3.3 mm min.

D4JL-□□FA-C6

D4JL-□□FA-D6

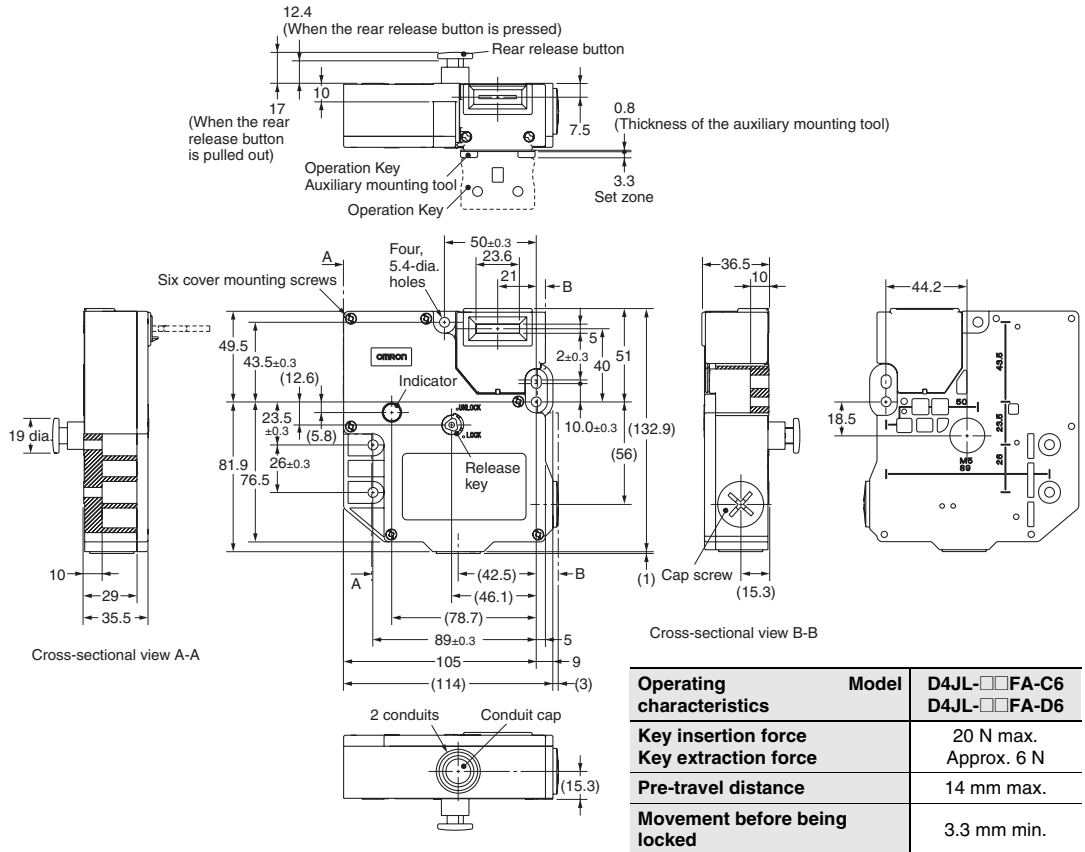
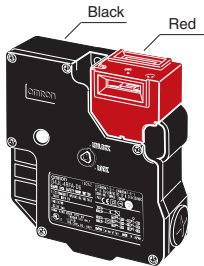

Operating characteristics	Model	D4JL-□□FA-C6 D4JL-□□FA-D6
Key insertion force		20 N max.
Key extraction force		Approx. 6 N
Pre-travel distance		14 mm max.
Movement before being locked		3.3 mm min.

D4JL-□□FA-C7
D4JL-□□FA-D7

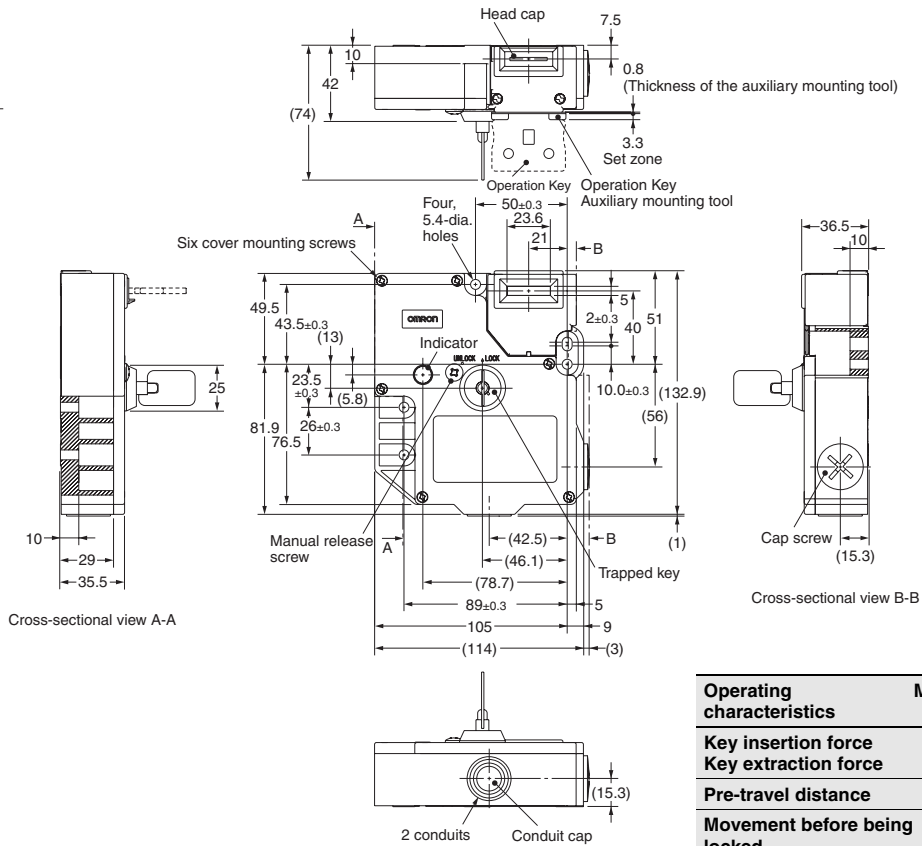
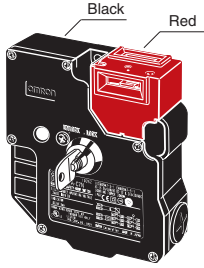

Operation Keys

D4JL-K1

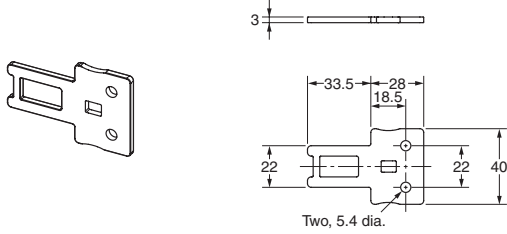

D4JL-K2

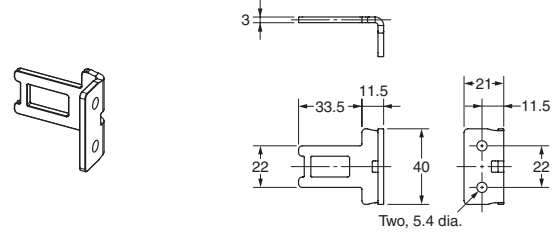

D4JL-K3

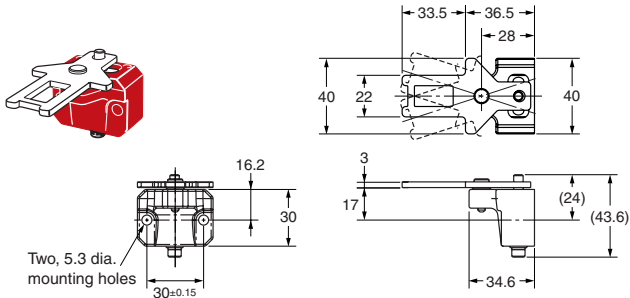

Note: Unless otherwise specified, a tolerance of ± 0.8 mm applies to all Switch dimensions and a tolerance of ± 0.4 mm applies to Operation Key dimensions.

With Operation Key Inserted

D4JL+D4JL-K1
(with Front-inserted Operation Key)

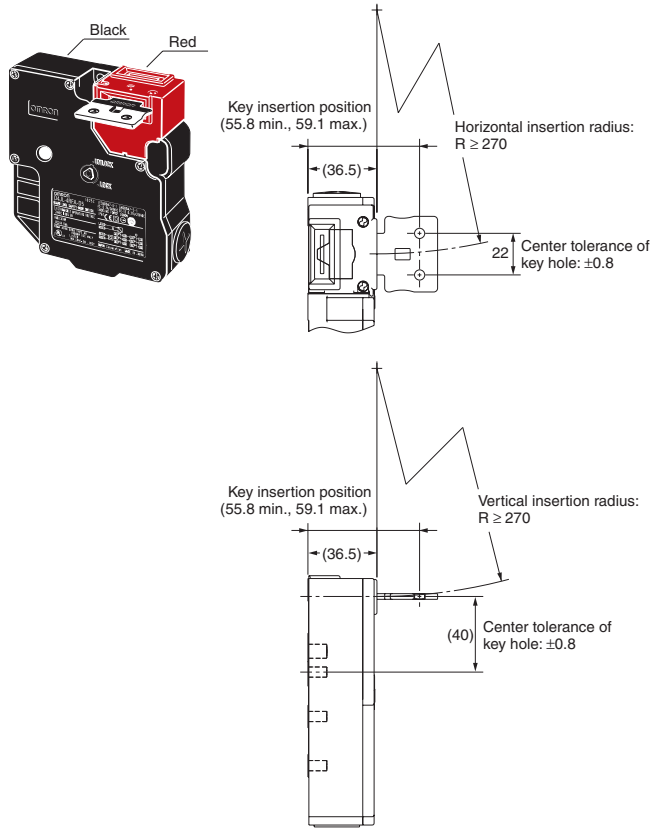

D4JL+D4JL-K1
(with Top-inserted Operation Key)

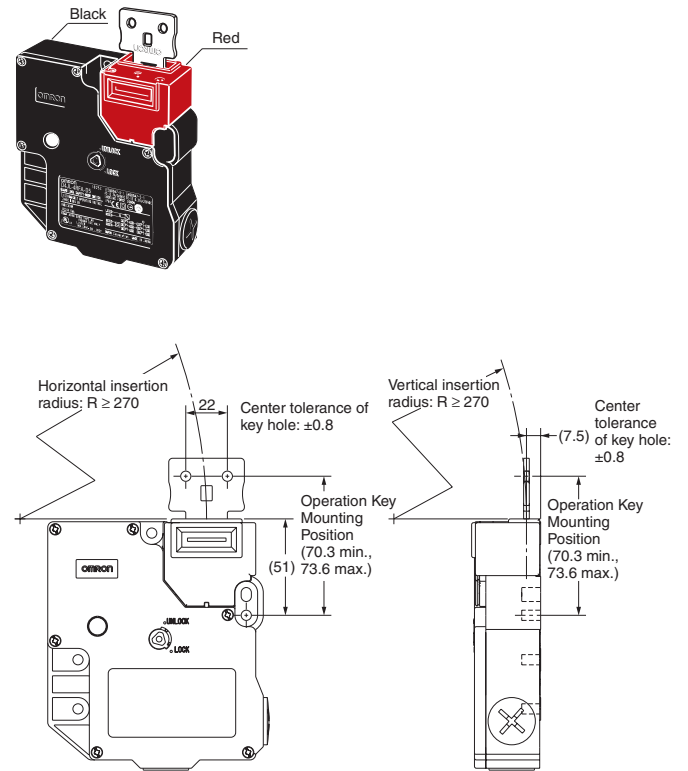

D4JL+D4JL-K2
(with Front-inserted Operation Key)

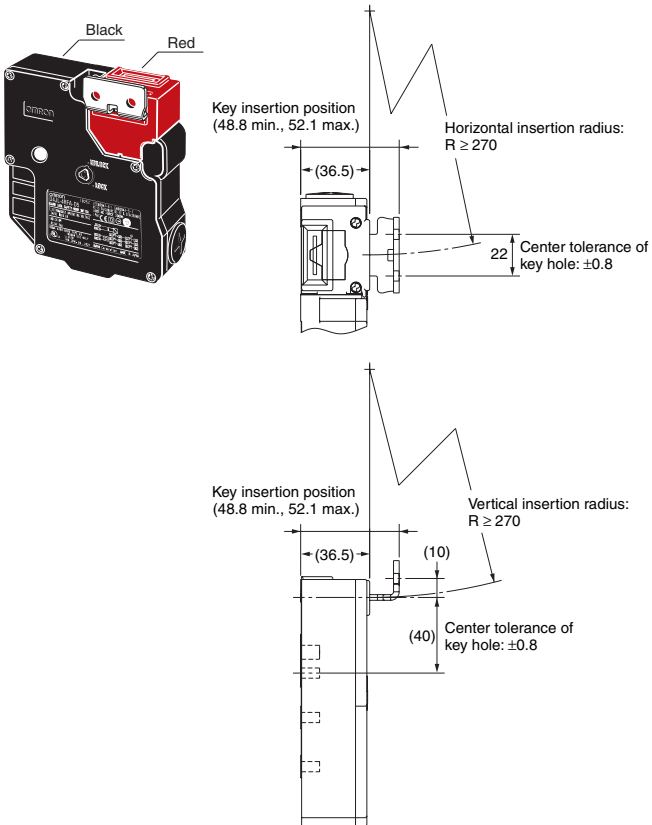

D4JL+D4JL-K2
(with Top-inserted Operation Key)

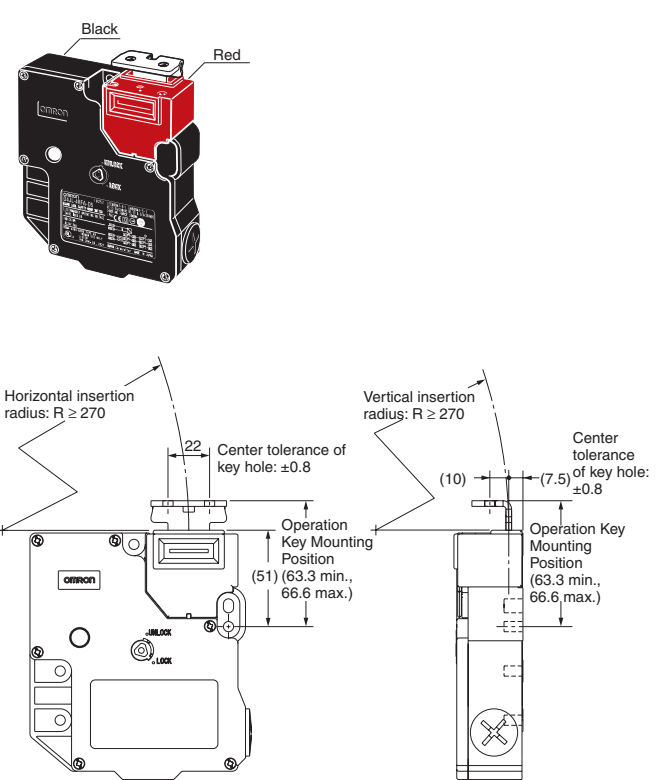

**D4JL + D4JL-K3
(with Front-inserted Operation key)**

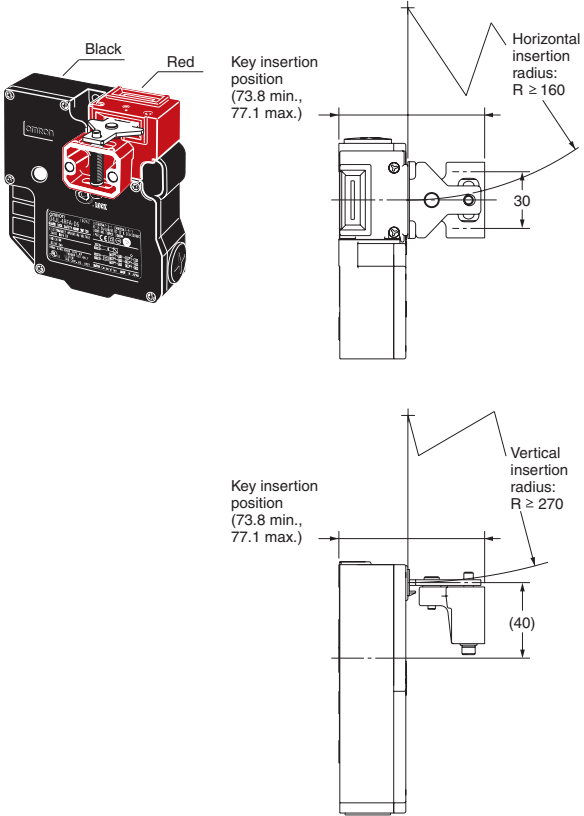

**D4JL + D4JL-K3
(with Top-inserted Operation key)**

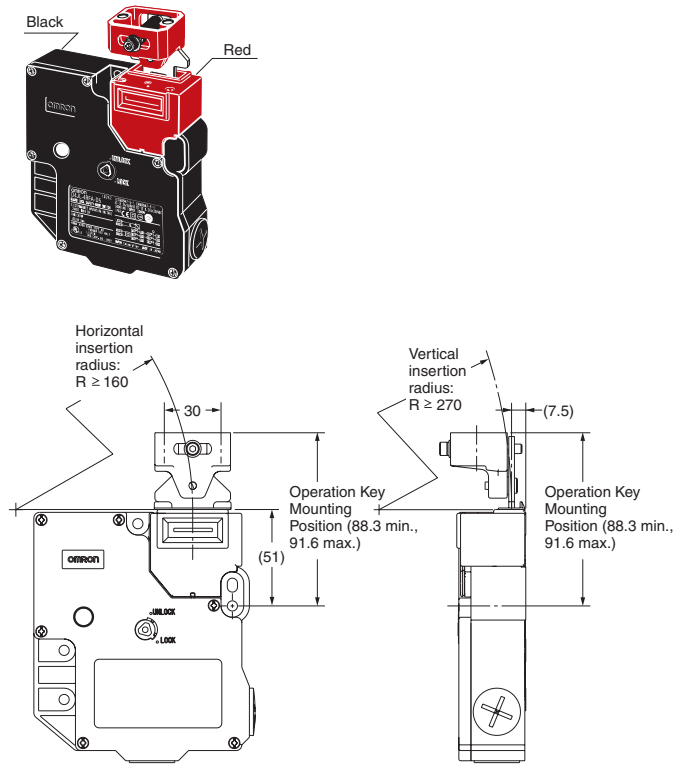

Application Examples

G9SA-321-T□ (24 VAC/VDC) + D4JL-□□□A-□□ (Mechanical Lock Models)/Manual Reset

Application Example Stopping a Robot on a Conveyor Line

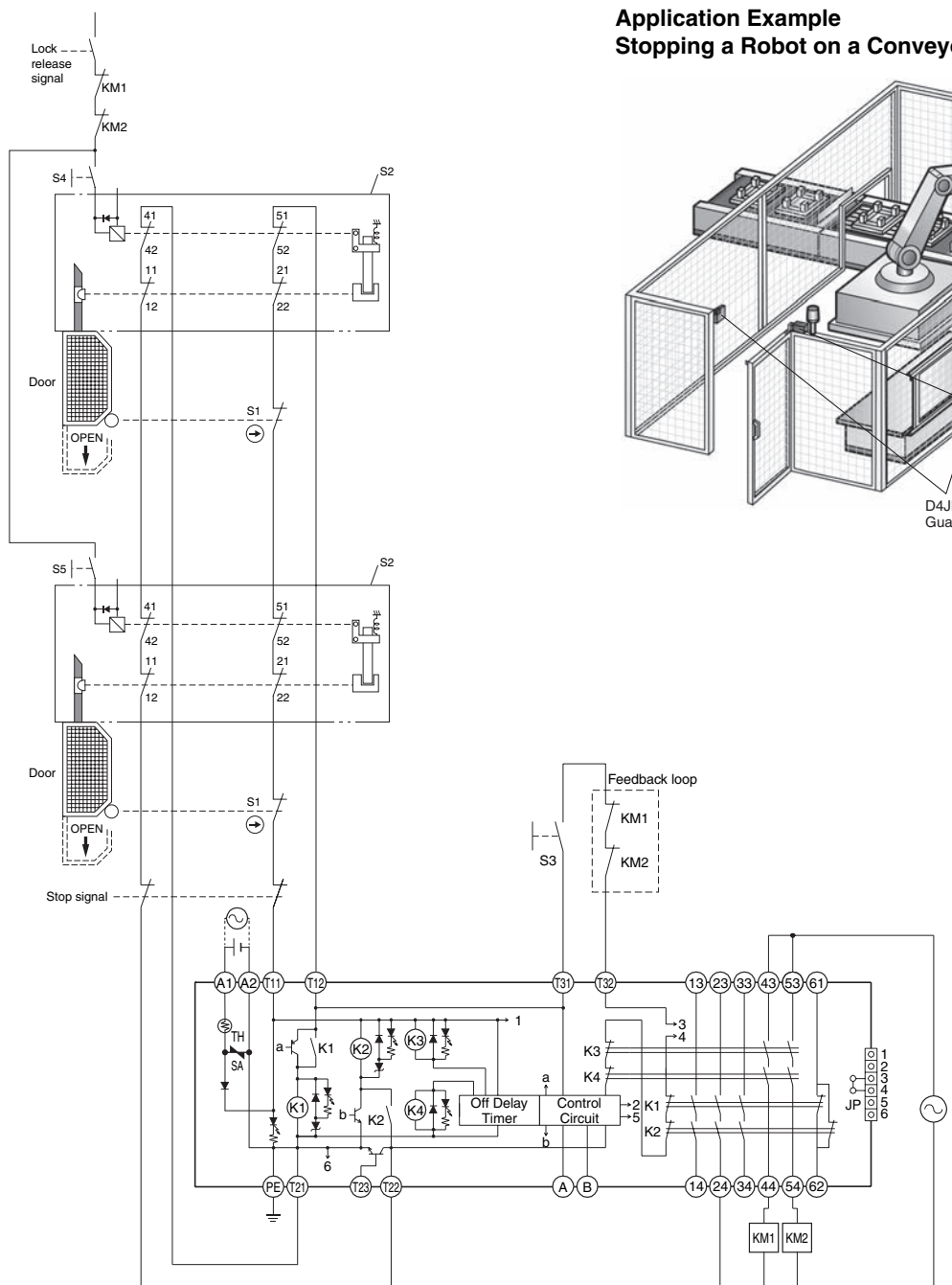
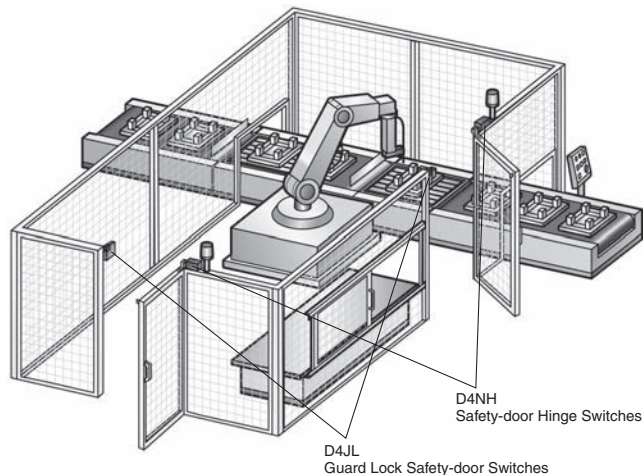

- S1: Safety-door Switch with direct opening contact
- S2: Guard Lock Safety-door Switch
- S3: Reset switch
- S4 and S5: Lock release switches
- KM1 and KM2: Magnetic contactors
- M: 3-phase motor

- Note:**
1. The above example circuit is for Category 3.
 2. When the release button is pressed on rear release models, the solenoid contacts are turned OFF.
 3. With Trapped Key Models, the door will not lock when it is closed with the trapped key removed.

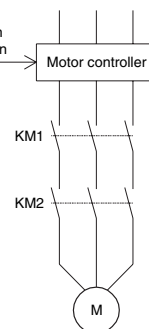

G9SX-AD322-T15 (24 VDC) + D4JL-□□□A-□□ (Mechanical Lock Models)/Manual Reset

**Application Example
Machining Center**

- The entire machining center will stop when the emergency stop button is pressed.
- Power will not be supplied to the corresponding motor when a door is open.

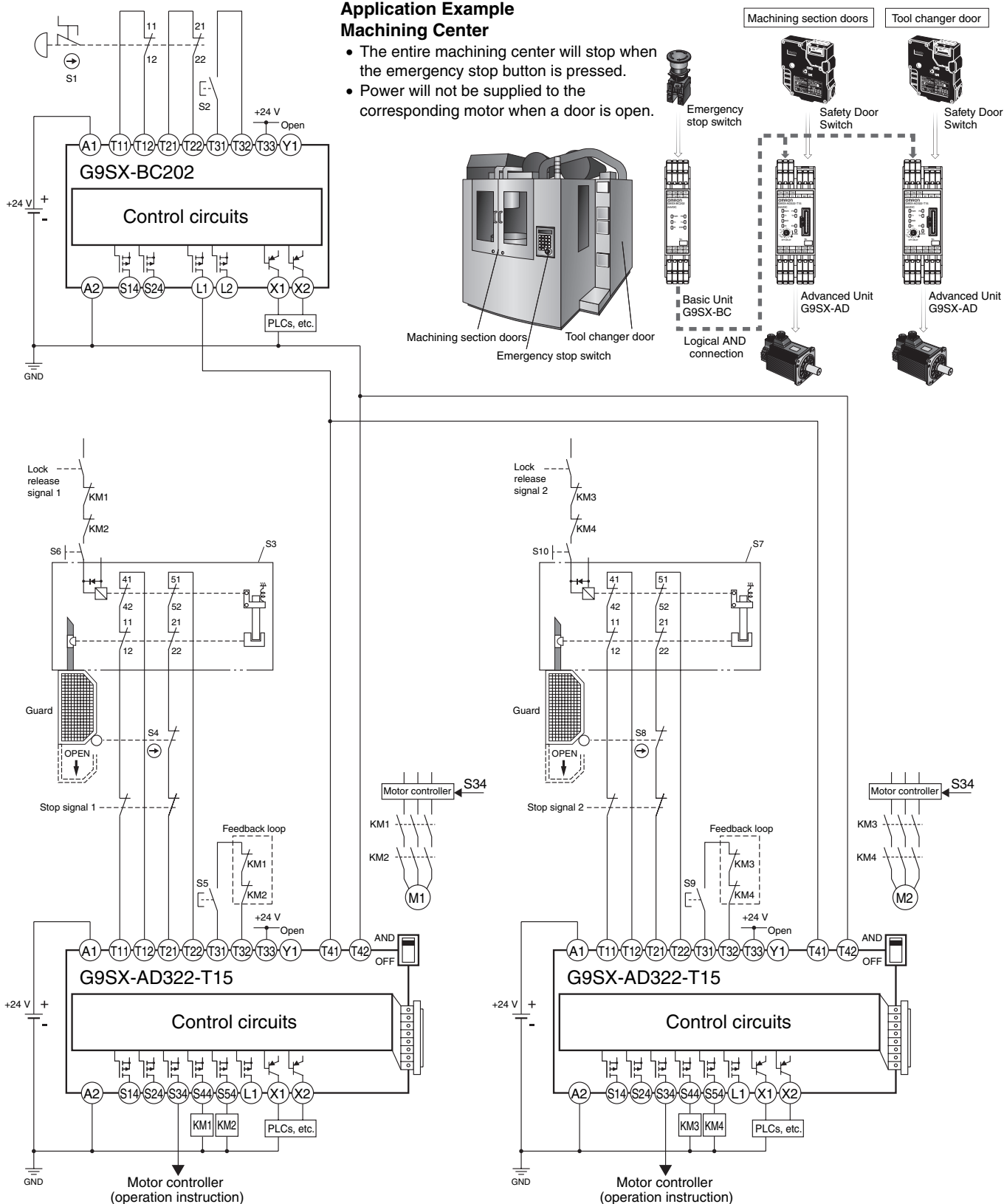

- S1: Emergency stop switch
 S3 and S7: Guard Lock Safety-door Switches
 S2, S5, and S9: Reset switches
 S6 and S10: Lock release switches
 S4 and S8: Safety Limit Switches with direct opening contacts
 KM 1, KM 2, KM3, and KM4: Magnetic contactors
 M1 and M2: 3-phase motors

Note: The above example circuit is for Category 4.

Safety Precautions

Refer to the “*Precautions for All Switches*” and “*Precautions for All Safety Door Switches*”.

DANGER

Injury may occasionally occur. Always check to make sure that the safety functions operate correctly before using the machine. The safety functions may not operate correctly because of wiring mistakes, setting mistakes, or Switch malfunction, causing some machines to continue operating in situations where they should be stopped. 

Injury may occasionally occur. If the machine is used with the release key in the UNLOCK position, the electromagnetic lock may not operate, causing some machines to continue operating in situations where they should be stopped. Be sure to put the release key in the LOCK position before using the machine. Also, check the condition of the lock and safety circuits. 

Injury may occasionally occur. When the electromagnetic lock function or Switch function is damaged, some machines may continue operating in situations where they should be stopped. Do not use the electromagnetic lock function of the Switch in place of a door lock. Always provide a lock separate from the Switch, attach a warning seal to prevent people from using excessive force to open the door when it is locked, or provide an indicator lamp to show the locked/unlocked status of the door. 

CAUTION

Electric shock may occasionally occur.
Do not use metal connectors or metal conduits. 

Precautions for Safe Use

Installation Environment

- Do not use the Switch submersed in oil or water or in locations continuously subject to splashes of oil or water. Doing so may result in oil or water entering the Switch. (The IP67 degree of protection of the Switch specifies the amount of water penetration after the Switch is submersed in water for a certain period of time.)

Wiring

- Do not switch circuits for two or more standard loads (250 VAC, 3 A) at the same time. Doing so may adversely affect insulation performance.
- Do not use screws longer than 9 mm when using metal connectors. Otherwise it may result in electric shock.
- Do not use metal conduits. Damage to the conduit opening may result in an improper seal or electric shock.
- Do not use metal connectors or metal conduits when using 1/2-14NPT connectors. Damage to the conversion adapter may result in an improper seal or electric shock.
- Always attach the cover after completing wiring and before using the Switch. Do not supply power when the cover is not attached. Electric shock may occur if the Switch is used without the cover attached.

Installation

- Make sure the Switch is mounted securely to prevent it from falling off. Otherwise injury may result.
- Do not use the Switch as a stopper. Be sure to install a stopper as shown in the following illustration when mounting the Switch and adjust the stopper so that the Operation Key is within the setting zone. Do not subject the Switch to a shock that exceeds the Switch's shock resistance of 1,000 m/s².

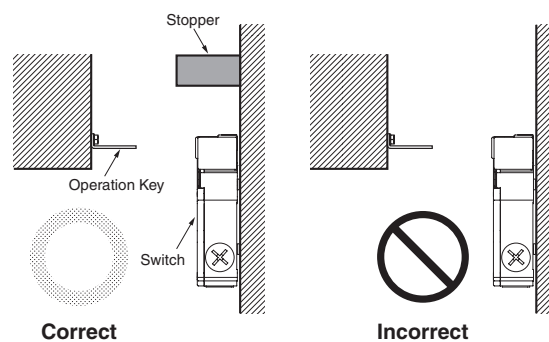

Precautions for Correct Use

Operation Key

- Use only the designated Operation Key. The Head has been designed so that operation is not possible with a screwdriver or other tools. Using anything other than the designated Operation Key may damage the Switch or affect machine safety.
- Do not operate the Switch with anything other than the special OMRON Operation Key, otherwise the Switch may break or the safety of the system may not be maintained.
- Do not impose excessive force on the Operation Key while the Key is inserted into the Switch or drop the Switch with the Operation Key inserted. Doing either of these may deform the Key or break the Switch.

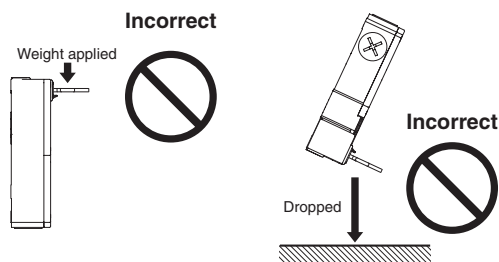

Switch Contacts

The Switch contacts can be used with either standard loads or microloads. Once the contacts have been used to switch a load, however, they cannot be used to switch smaller loads. The contact surfaces will become rough once they have been used and contact reliability for smaller loads may be reduced.

Release Key

- The release key is used to unlock the Switch in case of emergency or if the power supply to the Switch stops.
- If the release key setting is changed from LOCK to UNLOCK using the enclosed release key, the lock will be released and the safety door can be opened (mechanical lock models only).
- After setting the release key to UNLOCK to, for example, change the head direction or perform maintenance, be sure to return it to the LOCK setting before resuming operation.
- The release key is set in the unlock position at the factory for the D4JL-□□□A-□5 and D4JL-□□□A-□6 and in the lock position for the D4JL-□□□G-□5 and D4JL-□□□A-□7-□□.
- If the release key is set to UNLOCK when the Switch is used for the door of a machine room to ensure the safety of people performing adjustment work inside, the door will not be locked when the door is closed and no power will be supplied to the equipment.
- Do not use the release key to start or stop machines.
- The auxiliary lock must be released using the release key only by authorized personnel.
- Do not impose a force exceeding 1 N·m on the release key screws. The release key may be damaged and may not operate properly.
- To prevent the release key from being used by unauthorized personnel, set it to LOCK and seal it with sealing wax.

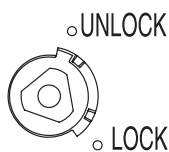

Rear Release Button

- The rear release button is used for emergency escapes when someone locks a worker in the work area (hazardous area).
- The door can be unlocked by pressing the rear release button.
- After the rear release button is used to unlock the door, pull the button out to restore it to its original state. If the button is left pressed in, the door will not lock when the door is closed and power will not be supplied to the equipment.
- Mount the Switch so that the rear release button can be operated by a worker inside the work area (hazardous area).

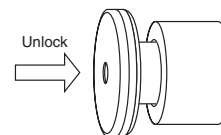

Trapped Key

- The trapped key is released when power is supplied to the solenoid. Turn the trapped key to the UNLOCK position and remove the key to unlock the door. The door cannot be unlocked solely by supplying power to the solenoid. As long as a worker has the trapped key with him when he enters the work area (hazardous area), he cannot be locked inside by another worker.
- Do not impose a force exceeding 1 N·m when operating the key. Otherwise, the Switch may be damaged and may not operate properly.

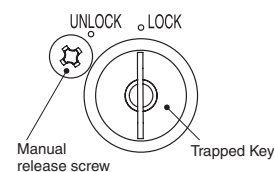

Attaching a Cover

- Make sure the release key is set to the LOCK position before covering the D4JL.
- When attaching a cover, be sure that the seal rubber is in place and that there is no foreign material present. If the cover is attached with the seal rubber out of place or if foreign material is stuck to the rubber, a proper seal will not be obtained.
- Do not use any screws to connect the cover other than the specified ones. The seal characteristics may be reduced.
- Use one of the following methods when covering a Trapped Key Switch.
 - When the Operation Key is removed (door open):
Cover with the trapped key removed (UNLOCK).
 - When the Operation Key is inserted (door closed):
Cover with the trapped key inserted (LOCK).

Manual Release

- Manual release is used to unlock the Switch when power cannot be supplied to the solenoid, such as when power is interrupted or the equipment is being repaired.
 - Use a Phillips screwdriver to remove the manual release screw. Use a precision screwdriver to press down the lever inside the Switch far enough to release the trapped key.
 - The door is unlocked when the trapped key is turned to the UNLOCK position and removed.
- Do not use manual release to stop machines.
- After the Switch has been manually released, re-install the manual release screw in its proper position on the Switch using the specified torque.

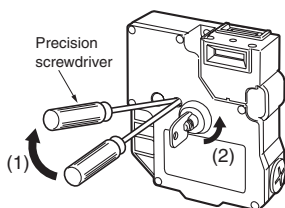

Hinged Doors

If the Switch is mounted too close to the hinge, the force imposed on the lock will be much larger than for locations far from the hinge and the lock may be damaged. Mount the Switch close to the handle.

Solenoid Lock Models

The solenoid lock locks the door only when power is supplied to the solenoid. The door will be unlocked if the power supply to the solenoid stops. Therefore, do not use the solenoid lock models for machines that may be operating and dangerous even after the machine stops operating.

Mounting Methods

Appropriate Tightening Torque

Be sure to tighten each screw of the Switch properly. Loose screws may result in malfunction.

Type	Appropriate tightening torque
Terminal screw	0.6 to 0.8 N·m
Cover mounting screw	0.7 to 0.9 N·m
Manual release screw	0.6 to 0.8 N·m
Operation Key mounting screw	2.4 to 2.8 N·m
Switch mounting screw	3.2 to 3.8 N·m
Connector	1.8 to 2.2 N·m (except 1/2-14NPT)
	1.4 to 1.8 N·m (for 1/2-14NPT)
Cap screw	1.3 to 1.7 N·m

Switch and Operation Key Mounting

- Mount the Switch and Operation Key securely to the applicable tightening torque with M5 screws and flat or spring washers. To ensure safety, use screws that cannot be easily removed or another means to prevent the Switch and Operation Key from easily being removed.

Mounting Holes for Switches

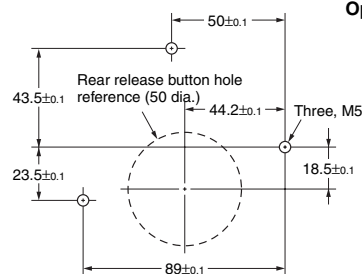

Mounting Holes for Operation Keys

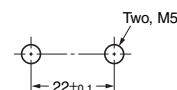

- Do not operate the Switch with anything other than the special OMRON Operation Key. Otherwise, the Switch may be damaged and the safety of the system may not be maintained.
- Ensure that the alignment offset between the Operation Key and the key hole does not exceed ± 0.8 mm. If the Operation Key is offset or at an angle, accelerated wear or damage to the Switch may result.
- When inserting the Operation Key, install the provided mounting auxiliary tool in the key hole and use the tool to position the key in the key hole center and set zone.
- Remove the mounting auxiliary tool from the Switch after the Operation Key is properly inserted.
- Observe the specified insertion radius for the Operation Key and insert it in a direction perpendicular to the key hole.

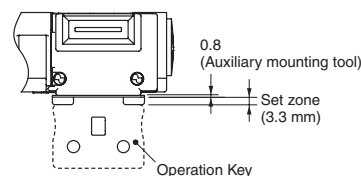
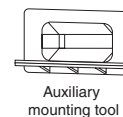

- Do not impose excessive force on the Operation Key while the Key is inserted into the Switch or drop the Switch with the Operation Key inserted. Doing either of these may deform the Key or break the Switch.
- Attach the enclosed cap head to any Operation Key hole that is not used.

Securing Doors

When the door is closed (with the Operation Key inserted), the Operation Key may exceed the set zone because of, for example, the door's own weight, machine vibration, or the door cushion rubber. Then, when an attempt is made to open the door, it may result in damage or malfunction. Also, it may not be possible to unlock the Switch if there is weight placed on the Operation Key. Do not rely on the Switch to substitute for a door locking device. Secure the door with a stopper so that the Operation Key remains within the set zone.

Wiring

Circuit Connection Example

- Direct opening contacts used for safety circuit inputs are indicated with the ⊖ mark. Terminals 12-41 and terminals 22-51 have direct opening contacts.
- Connect the indicators in parallel to the auxiliary circuits or terminals E1 and E2. Do not connect the indicators in parallel with the direct opening contact. If the indicators are broken, a short-circuit current may flow, causing equipment to malfunction.
- The 24 VDC solenoid terminals have polarity (E1: +, E2: -). Confirm the polarity before wiring.
- The contact ON/OFF timing for Switches is not synchronized. Confirm performance before application.

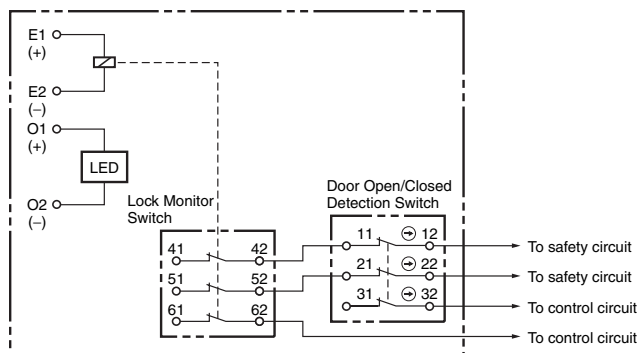

Wiring

- Do not wire the Switch while power is being supplied. Doing so may result in electric shock.
- Do not let particles, such as small pieces of lead wire, enter the switch body when wiring.
- Make sure that the wiring does not hide the LED indicator when wiring E1/E2 or O1/O2.
- When connecting to the terminals via insulating tube and M3.5 crimp terminals, arrange the crimp terminals so that they do not rise up onto the case or the cover.
- Applicable lead wire size: AWG22 to AWG18 (0.3 to 0.75 mm²). Use lead wires of an appropriate length. Not doing so may result in excess length causing the cover to rise and not fit properly.
- Do not pull on the lead wires with excessive force. Doing so may disconnect them.
- Do not push crimp terminals into gaps in the case interior. Doing so may cause damage or deformation of the case.

[Reference] Crimp Terminals

Manufacturer	Model
J.S.T. Mfg Co.	FN1.25-M4 (F Type) N1.25-M4 (Straight Type)

t: 0.8 mm
dz dia: 4.3 mm
D dia: 4.0 mm
B: 6.6 mm
L: 18.6 mm
F: 6.3 mm
l: 9.0 mm

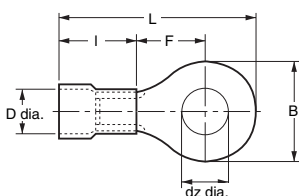

Correct

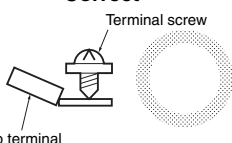

Incorrect



Crimp terminal

Processing the Conduit Opening

- Connect a recommended connector to the opening of the conduit and tighten the connector to the proper torque. The case may be damaged if excessive tightening torque is applied.
- When using a 1/2-14NPT conduit, wind sealing tape around the conduit end of the connector so that the enclosure will conform to IP67.
- Make sure that the outer diameter of the cable connected to the connector is correct.
- Attach a conduit cap to the unused conduit opening when wiring and tighten it to a suitable torque. The conduit cap is provided with the Switch.

Recommended Connectors

Use a connector with a screw section not exceeding 9 mm. Otherwise, the screws will protrude into the case interior. The connectors given in the following table have connectors with screw sections not exceeding 9 mm. Use the following connectors to ensure conformance to IP67.

Size	Manufacturer	Model	Applicable cable diameter
G1/2	LAPP	ST-PF1/2 5380-1002	6.0 to 12.0 mm
PG13.5	LAPP	ST-13.5 5301-5030	6.0 to 12.0 mm
M20	LAPP	ST-M20 × 1.5 5311-1020	7.0 to 13.0 mm
1/2-14NPT	LAPP	ST-NPT1/2 5301-6030	6.0 to 12.0 mm

Use LAPP connectors together with Seal Packing (JPK-16, GP-13.5, or GPM20), and tighten to the applicable torque. Seal Packing is sold separately.

- LAPP is a German manufacturer.
- For a 1/2-14NPT conduit, use the above connector after attaching the provided Adaptor to the Switch and wrapping it with sealing tape.

Other Precautions

- The solenoid will heat when it carries current. Do not touch it.

Read and Understand This Catalog

Please read and understand this catalog before purchasing the products. Please consult your OMRON representative if you have any questions or comments.

Warranty and Limitations of Liability

WARRANTY

OMRON's exclusive warranty is that the products are free from defects in materials and workmanship for a period of one year (or other period if specified) from date of sale by OMRON.

OMRON MAKES NO WARRANTY OR REPRESENTATION, EXPRESS OR IMPLIED, REGARDING NON-INFRINGEMENT, MERCHANTABILITY, OR FITNESS FOR PARTICULAR PURPOSE OF THE PRODUCTS. ANY BUYER OR USER ACKNOWLEDGES THAT THE BUYER OR USER ALONE HAS DETERMINED THAT THE PRODUCTS WILL SUITABLY MEET THE REQUIREMENTS OF THEIR INTENDED USE. OMRON DISCLAIMS ALL OTHER WARRANTIES, EXPRESS OR IMPLIED.

LIMITATIONS OF LIABILITY

OMRON SHALL NOT BE RESPONSIBLE FOR SPECIAL, INDIRECT, OR CONSEQUENTIAL DAMAGES, LOSS OF PROFITS OR COMMERCIAL LOSS IN ANY WAY CONNECTED WITH THE PRODUCTS, WHETHER SUCH CLAIM IS BASED ON CONTRACT, WARRANTY, NEGLIGENCE, OR STRICT LIABILITY.

In no event shall the responsibility of OMRON for any act exceed the individual price of the product on which liability is asserted.

IN NO EVENT SHALL OMRON BE RESPONSIBLE FOR WARRANTY, REPAIR, OR OTHER CLAIMS REGARDING THE PRODUCTS UNLESS OMRON'S ANALYSIS CONFIRMS THAT THE PRODUCTS WERE PROPERLY HANDLED, STORED, INSTALLED, AND MAINTAINED AND NOT SUBJECT TO CONTAMINATION, ABUSE, MISUSE, OR INAPPROPRIATE MODIFICATION OR REPAIR.

Application Considerations

SUITABILITY FOR USE

OMRON shall not be responsible for conformity with any standards, codes, or regulations that apply to the combination of products in the customer's application or use of the products.

At the customer's request, OMRON will provide applicable third party certification documents identifying ratings and limitations of use that apply to the products. This information by itself is not sufficient for a complete determination of the suitability of the products in combination with the end product, machine, system, or other application or use.

The following are some examples of applications for which particular attention must be given. This is not intended to be an exhaustive list of all possible uses of the products, nor is it intended to imply that the uses listed may be suitable for the products:

- Outdoor use, uses involving potential chemical contamination or electrical interference, or conditions or uses not described in this catalog.
- Nuclear energy control systems, combustion systems, railroad systems, aviation systems, medical equipment, amusement machines, vehicles, safety equipment, and installations subject to separate industry or government regulations.
- Systems, machines, and equipment that could present a risk to life or property.

Please know and observe all prohibitions of use applicable to the products.

NEVER USE THE PRODUCTS FOR AN APPLICATION INVOLVING SERIOUS RISK TO LIFE OR PROPERTY WITHOUT ENSURING THAT THE SYSTEM AS A WHOLE HAS BEEN DESIGNED TO ADDRESS THE RISKS, AND THAT THE OMRON PRODUCTS ARE PROPERLY RATED AND INSTALLED FOR THE INTENDED USE WITHIN THE OVERALL EQUIPMENT OR SYSTEM.

PROGRAMMABLE PRODUCTS

OMRON shall not be responsible for the user's programming of a programmable product, or any consequence thereof.

Disclaimers

CHANGE IN SPECIFICATIONS

Product specifications and accessories may be changed at any time based on improvements and other reasons.

It is our practice to change model numbers when published ratings or features are changed, or when significant construction changes are made. However, some specifications of the products may be changed without any notice. When in doubt, special model numbers may be assigned to fix or establish key specifications for your application on your request. Please consult with your OMRON representative at any time to confirm actual specifications of purchased products.

DIMENSIONS AND WEIGHTS

Dimensions and weights are nominal and are not to be used for manufacturing purposes, even when tolerances are shown.

PERFORMANCE DATA

Performance data given in this catalog is provided as a guide for the user in determining suitability and does not constitute a warranty. It may represent the result of OMRON's test conditions, and the users must correlate it to actual application requirements. Actual performance is subject to the OMRON Warranty and Limitations of Liability.

ERRORS AND OMISSIONS

The information in this document has been carefully checked and is believed to be accurate; however, no responsibility is assumed for clerical, typographical, or proofreading errors, or omissions.

2010.8

In the interest of product improvement, specifications are subject to change without notice.

OMRON Corporation
Industrial Automation Company

<http://www.ia.omron.com/>

(c)Copyright OMRON Corporation 2010 All Right Reserved.

Mouser Electronics

Authorized Distributor

Click to View Pricing, Inventory, Delivery & Lifecycle Information:

[Omron:](#)

[D4JL2NFAC5](#) [D4JL-2NFA-C5](#) [D4JL-2NFA-D5](#) [D4JL-K1](#) [D4JL-K2](#) [D4JL-K3](#) [D4JL-SK40](#) [D4JL-2NFA-C6](#) [D4JL-2NFG-C5](#) [D4JL-2NFG-D5](#) [D4JL-4NFA-C5](#) [D4JL-4NFA-C7-01-NPT](#)