

Contents	Pages
Section Overview	10/2 - 10/3
3SB2, 16mm Mounting Diameter Pilot Devices	
Introduction	10/4
Technical Specifications	10/5
PCB Mounting Instructions	10/6
Complete Units	10/7 - 10/8
Pushbutton and Selector Switch Operators	10/9
Key-operated Switches and Indicator Lights	10/10
Holders, Lampholders and Contact Blocks with Tabs	10/11
Holders, Lampholders and Contact Blocks with Solder Pins	10/12
Inserts, Legend Plates, and Accessories	10/13 - 10/19
Dimension Drawings	10/20
Sirius 3SB3 22mm Mounting Diameter Pilot Devices	
Introduction	10/22 - 10/23
Technical Specifications	10/24 - 10/25
3SB3 Metal Round	
Complete Units	10/26 - 10/30
Pushbutton Operators	10/31 - 10/32
Emergency-stop Mushroom Pushbutton Operators	10/39
Indicator Lights	10/40
Selector Switch Operators	10/33 - 10/36
Key Operated Switch Operators	10/37 - 10/38
3SB3 Plastic Round	
Complete Units	10/41 - 10/47
Pushbutton Operators	10/48 - 10/49
Emergency-stop Mushroom Pushbutton Operators	10/53
Indicator Lights	10/54
Selector Switch Operators	10/50
Key Operated Switch Operators	10/51 - 10/52
Joystick Switches	10/56 - 10/58
Twin Pushbutton Operators	10/54 - 10/55
3SB3 Plastic Square	
Complete Units	10/59 - 10/60
Pushbutton Operators	10/61
Selector Switch Operators	10/62
Key Operated Switches	10/63
Emergency-stop Mushroom Pushbuttons	10/64
Indicator Lights	10/64
3SB3 Contact Blocks and Lampholders	10/65 - 10/68
3SB3 Special Key Operated Switches	10/69
3SB3 Contact Block Position Chart for Selector Switches	10/70
3SB3 Laser Inscription and Legend Plates	10/71 - 10/78
3SB3 Accessories and Spare Parts	10/79 - 10/86
Sirius 3SB3 22mm Enclosed Pushbutton Stations	
Introduction	10/87
Assembled Metal and Plastic Enclosures with Standard Devices	10/88 - 10/89
Empty Enclosures	10/90
Customized Enclosures	10/91
Contact Blocks and Lampholders	10/92 - 10/93
Enclosure Accessories	10/95
Enclosure Labelling with Inscription Plates	10/94
Dimension Drawings	10/100 - 10/106
Wiring Schematic for Lampholders with Separate Lamp Test Function	10/107
22mm Communication Capable Networked Products	
As Interface Adapter For E-Stop	10/96
Assembled Enclosures	10/97 - 10/98
Field Assembled Components for Enclosures	10/99

Contents	Pages
Sirius Signal Columns	
Introduction	10/110 - 10/111
Technical Specifications	10/112
8WD42 signaling columns, 50 mm diameter and accessories	10/113 - 10/114
8WD44 signaling columns, 70 mm diameter and accessories	10/115 - 10/118
8WD53 beacons, 70 mm diameter	10/119
Dimensional Drawings	10/120 - 10/122
3SE2, 3SE3 Foot Switches	
Introduction	10/108
Plastic and Metal Enclosures	10/109
Class 50 Standard Duty Control Stations	
Introduction	10/123
Standard Duty Type 1 and 1B	10/124 - 10/128
Heavy Duty Type 4 Stations	10/129
Class 50 Accessories	10/130
Dimension Drawings	10/131
Class 51 NEMA Type 7/9 Hazardous Location Pilot Devices	
Introduction	10/132
Pushbutton and Push-pull Operators	10/133
Indicator Lights	10/134
Push to Test/Illuminated Pushbutton Complete Units	10/135
Selector Switch Operators	10/136
Keyed Selector Switch Operators	10/137
Cam Selection Guide for Selector Switch	10/138
Stations and Enclosures	10/139
Accessories	10/140 - 10/142
Class 52 30.5mm Mounting Diameter Pilot Devices	
Introduction	10/143
Momentary Push Button, Non-Illuminated	10/144 - 10/145
2 & 3 Position Push-Pull Mushroom Head Devices, Non-Illuminated	10/146 - 10/147
2 & 3 Position Push-Pull Mushroom Head Devices, Illuminated	10/148 - 10/149
2 Position Twist-to-Release Mushroom Head Devices, Non-Illuminated	10/150
2 Position Twist-to-Release Mushroom Head Devices, Illuminated	10/151
Indicator Light	10/152 - 10/153
Push Button & Push-to-Test, Illuminated	10/154 - 10/155
Push Button Mushroom Head Devices, Illuminated	10/156
Selector Switches, Illuminated	10/157
Selector Switch Short & Long Lever, Non-Illuminated	10/158 - 10/159
Keyed Selector Switch	10/160 - 10/161
Selector Push Button	10/162
Special Devices	10/163
Cam Selection Guide for Selector Switch, Keyed Selector Switch and Selector Pushbutton	10/164
Custom Selector Switch Designs	10/165
Accessories and Spare Parts	10/166 - 10/169
Dimensional Drawings	10/170 - 10/173
Class 52 30.5mm Enclosed Pushbutton Stations	
Assembled Enclosures with Standard Devices	10/174 - 10/175
P30 Empty Enclosures Only	10/176
Enclosure Legend Plates	10/177
Enclosure Dimensions	10/178
Technical Specifications	10/179

Control and Signaling Devices

Push Button Units and Indicator Lights

16 mm mounting diameter, molded-plastic



3SB2	Page
Selection and ordering data	
• 3SB22 complete units	10/7
• 3SB20 pushbuttons and lens assemblies	10/9
• 3SB2 holders, lampholders and contact blocks	10/11
• 3SB29 inserts, legend plates, and accessories	10/13

Introduction	10/4
Technical specifications	10/5
Dimension drawings	10/21

22 mm mounting diameter, metal



SIRIUS 3SB3, metal round	Page
Selection and ordering data	
• 3SB36 complete units	10/26
• 3SB35 pushbuttons and lens assemblies with holder	10/31
• 3SB34 contact blocks and, lampholders	10/65
• 3SB3 accessories	10/79

Introduction	10/22
Technical specifications	10/24
Dimension drawings	10/100

22 mm mounting diameter, molded-plastic

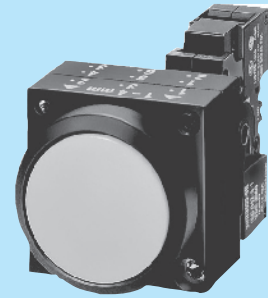

SIRIUS 3SB3, plastic round	Page
Selection and ordering data	
• 3SB32 complete units	10/41
• 3SB30 pushbuttons and lens assemblies with holder	10/48
• 3SB3 twin pushbuttons	10/54
• 3SB19, 36B39 accessories	10/54, 10/79
• 3SB34 contact blocks and lampholders	10/65

Introduction	10/22
Technical specifications	10/24
Dimension drawings	10/100

26 mm x 26 mm mounting cutout, molded-plastic

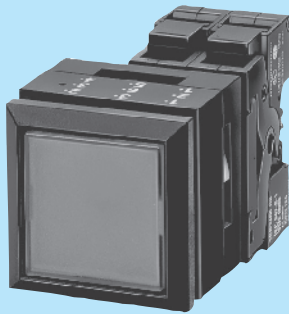

SIRIUS 3SB3, plastic square	Page
Selection and ordering data	
• 3SB33 complete units	10/59
• 3SB31 pushbuttons and lens assemblies with holder	10/61
• 3SB34 contact blocks and lampholders	10/65
• 3SB19 accessories	10/79

Introduction	10/22
Technical specifications	10/24
Dimension drawings	10/100

Enclosed devices, 22 mm mounting diameter



SIRIUS 3SB3, plastic square	Page
Selection and ordering data	
• 3SB38 enclosures with standard equipment	10/78
• 3SB34 contact blocks and lampholders	10/90
• 3SB38 empty enclosures	10/90
• 3SB38 enclosures with choice of equipment	10/91
• 3SB19 accessories, labels	10/95

Introduction	10/87
Dimension drawings	10/100

Communication-capable switching devices

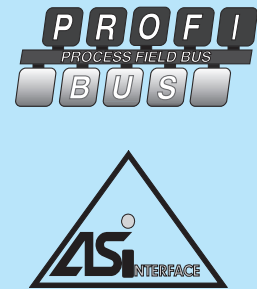

SIRIUS 3SB3, plastic square	Page
Selection and ordering data	
• Assembled enclosures	10/97
• Field assembled components for enclosures	10/99

Control and Signaling Devices

Push Button Units and Indicator Lights

1
2
3
4
5
6
7
8
9
10

SIRIUS signal columns, built-in signal beacons and foot switches

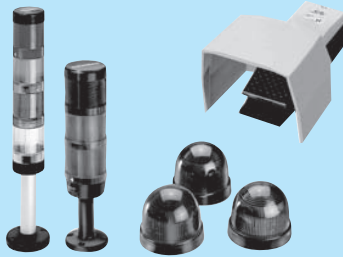

3SE2, 3SE3 Foot Switches Page

Selection and ordering data

- Plastic and metal enclosures 10/109
- Lamp & LED version, enclosure diameters 50 and 70 mm**
- 8WD42 selection and accessories 10/113
- 8WD44 selection and accessories 10/115
- 8WD53 beacons 10/119

Introduction	10/110
Technical Specifications	10/112
Dimension drawings	10/120

Standard duty control stations

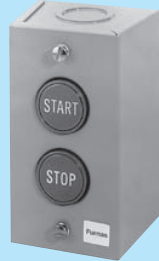

Class 50 Page

Selection and ordering data

- Standard duty Type 1 and 1B 10/124
- Heavy duty Type 4 10/129
- Class 50 accessories 10/130

Introduction	10/123
Technical Specifications	10/123
Dimension drawings	10/131

Type 7/9 hazardous location— 3/4"–14 NPSM

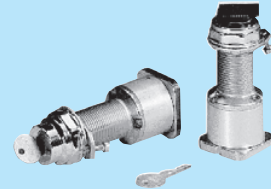

Class 51 Page

Selection and ordering data

- Push pull complete units 10/133
- Pilot lights 10/134
- Selector switches 10/136
- Push to test/illuminated push buttons 10/135
- Cam selection guide 10/138
- Stations and enclosures 10/139
- Accessories 10/140

Introduction	10/132
Technical Specifications	10/132

NEMA 30.5 mm mounting diameter, corrosion resistant, watertight & oiltight

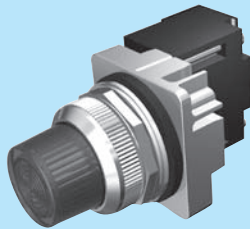

Class 52 Page

Selection and ordering data

- Momentary Push Button, Non-Illuminated 10/144-145
- 2 & 3 Position Push-Pull Mushroom Head Devices, Non-Illuminated 10/146-147
- 2 & 3 Position Push-Pull Mushroom Head Devices, Illuminated 10/148-149
- 2 Position Twist-to-Release Mushroom Head Devices, Non-Illuminated 10/150
- 2 Position Twist-to-Release Mushroom Head Devices, Illuminated 10/151
- Indicator Light 10/152-153

Introduction	10/143
Technical Specifications	10/178
Dimension drawings	10/169

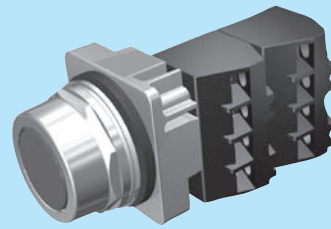

Class 52 Page

Selection and ordering data

- Push Button & Push-to-Test, Illuminated 10/154-155
- Push Button Mushroom Head Devices, Illuminated 10/156
- Selector Switches, Illuminated 10/157
- Selector Switch Short & Long Lever, Non-Illuminated 10/158-159
- Keyed Selector Switch 10/160-161
- Selector Push Button 10/162

30.5 mm heavy duty control stations, Type 4/4X/12/13 enclosures



Class 52 Page

Selection and ordering data

- Class 52 assembled stations with standard offerings 10/173
- P30 enclosures only 10/175
- Custom station order form 10/175
- Legend plates 10/176

Push Button Units and Indicator Lights

3SB2, Mounting Diameter 16 mm

General data

Overview

The 3SB2 push buttons and indicator lights are provided for front plate mounting and rear connection with flat connectors. For use on printed circuit boards, contact blocks and lamp holders with solder pins are also available.

Standards

IEC 60947-1, EN 60947-1,
IEC 60947-5-1, EN 60947-5-1,
IEC 60947-5-5, EN 60947-5-5 for EMERGENCY-STOP mushroom push buttons.

Version with flat connector

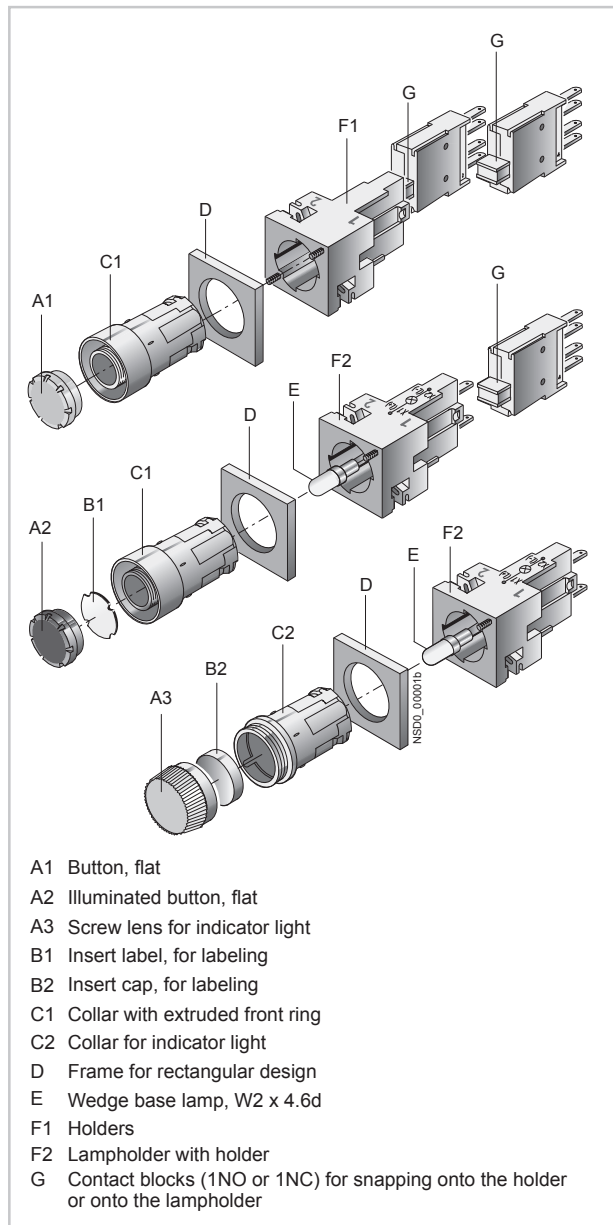

For PCB mounting

For use on printed circuit boards, special contact blocks and lamp holders for soldering into the printed circuit board are available. For this purpose, the contact blocks and lamp holders are fitted with 0.8 mm x 0.8 mm solder pins of length 3.5 mm.

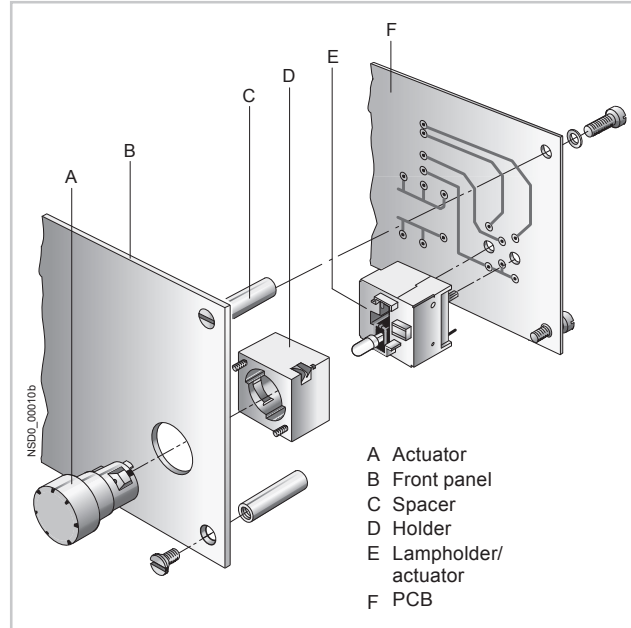

Connection methods



Flat connectors



Solder pin connections

The terminals are indicated in the corresponding tables by the symbols shown on blue backgrounds.

Application

The devices are climate-proof and suitable for marine applications.

Safety EMERGENCY-STOP push buttons according to ISO 13850

For controls according to IEC 60204-1 or EN 60204-1, the mushroom push buttons of the 3SB2 series are suitable for use as safety EMERGENCY-STOP push buttons.

Safety circuits

IEC 60947-5-1 and EN 60947-5-1 require positive opening, i.e. for the purposes of personal safety, the assured opening of NC contacts is expressly stipulated for the electrical equipment of machines in all safety circuits and marked according to IEC 60947-5-1 with the symbol ☹.

Category 4 according to EN 954-1 can be attained with the EMERGENCY-STOP mushroom push buttons if the corresponding failsafe evaluation units are selected and correctly installed, e.g. the 3TK28 safety relays or matching units from the ASIsafe, SIMATIC or SINUMERIK product ranges.

Push Button Units and Indicator Lights

3SB2, Mounting Diameter 16 mm

General data

1
2
3
4
5
6
7
8
9
10

Technical specifications

Type	3SB2	
Contact blocks and lamp holders		
Standards	IEC 60947-5-1, EN 60947-5-1 IEC 60947-5-5, EN 60947-5-5	
Rated insulation voltage U_i	V	250
Conventional thermal current I_{th}	A	10
Rated operational current I_e at rated operational voltage U_e		
• Alternating current AC-12 - At $U_e = 24 \dots 230$ V	A	10
• Alternating current AC-15 - At $U_e = 24 \dots 230$ V	A	4
• Direct current DC-12 - At $U_e = 24$ V	A	6
- At $U_e = 60$ V	A	5
- At $U_e = 110$ V	A	2.5
- At $U_e = 230$ V	A	1
• Direct current DC-13 - At $U_e = 24$ V	A	3
- At $U_e = 60$ V	A	1.5
- At $U_e = 110$ V	A	0.7
- At $U_e = 230$ V	A	0.3
Contact stability		
• Test voltage/test current	5 V/1 mA	
Lamps		
• Bases	Wedge base W2× 4.6 d	
• Rated voltage	V	6, 12, 24, 30, 48, 60
• Rated power, max.	W	1
Short-circuit protection weld-free according to IEC 60947-5-1		
• DIAZED fuse links, utilization category gG	10 A TDz, 16 A Dz	
• Miniature circuit breaker with C characteristic according to IEC 60898	10 A	
Electrical endurance	10 × 10 ⁶ operating cycles	
• For utilization category AC-15 with 3RT10 15 to 3RT10 26 contactors	10 × 10 ⁶ operating cycles	
Mechanical endurance	10 × 10 ⁶ operating cycles	
Degree of protection acc. to IEC 60529		
• Connection of contact blocks and lamp holders behind the front panel	IP00	
• Contact chambers of the contact blocks behind the front panel	IP40	
Finger-safe according to IEC 61140 and BGV A3	With voltages > 50 V AC or 120 V DC, insulation sleeves must be fitted to the unassigned tab connections.	
Data according to UL and CSA		
Rated voltage		
• Contact blocks	V	250 AC
• Indicator light (lamp with wedge base W2× 4.6 d)	V	60; 1 W
Uninterrupted current	A	5
Switching capacity	B 300, R 300	
Actuators and indicators		
Mechanical endurance		
• Push Buttons	10 × 10 ⁶ operating cycles	
• Actuators, rotary or maintained	3 × 10 ⁵ operating cycles	
• Illuminated push buttons	3 × 10 ⁶ operating cycles	
Climatic withstand capability	Climate-proof; suitable for marine applications	
Ambient temperature		
• During operation, non-illuminated devices and complete with LED	°C	-25 ... +70
• During operation, devices with incandescent lamp	°C	-25 ... +60
• During storage, transport	°C	-40 ... +80
Degree of protection acc. to IEC 60529		
• Actuators and indicators	IP65	
• Actuators and indicators with protective cap	IP67	
Protective measures		
• For mounting in metal front plates and enclosures	The actuators and lens assemblies must not be included in the protective measures.	
• For fitting into enclosures with total insulation	The protective measure "Total insulation" is retained.	
Shock resistance acc. to IEC 60068-2-27		
• Shock amplitude	ms	≤ 50 g
• Shock duration		11
• Shock form		Half-sine

More technical information see [Reference manual "Commanding and Signaling Devices"](#).

Push Button Units and Indicator Lights

3SB2, Mounting Diameter 16 mm

General data

Configuration

Design

Two design versions can be mounted:

- Round design: The 3SB2 push buttons and indicator lights are assembled with the modules – actuator, holder, contact block and lamp holder. Depending on the specific application, various versions can be assembled. Complete units are offered for the most commonly used applications.
- Square design: With square, black frames the round units can be given a square look. The frames are inserted underneath the round actuators. Further mounting is the same as for the round version.

Mounting and fixing:

Mounting dimensions according to EN 50007
(not applicable to EMERGENCY-STOP mushroom push buttons)

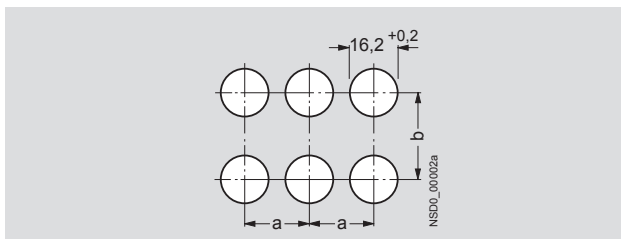

Minimum clearance	a	b
Round version	19	19
Square version without inscription label	21	21
Round and square version with inscription label	21	32
For 2 selector switches with 3 switch positions, maintained, side by side	21	21

For mounting, the actuator or the lens assembly is inserted from the front into the hole in the front plate. Four small nubs ensure a secure fitting in the hole. The holder is plugged on from the back and snaps automatically into place. The module is fixed to the holder with 2 screws so that it is immune to vibrations.

One or two contact blocks can be mounted on the holder. They are inserted into the holder with slide slots and held down with two snap brackets.

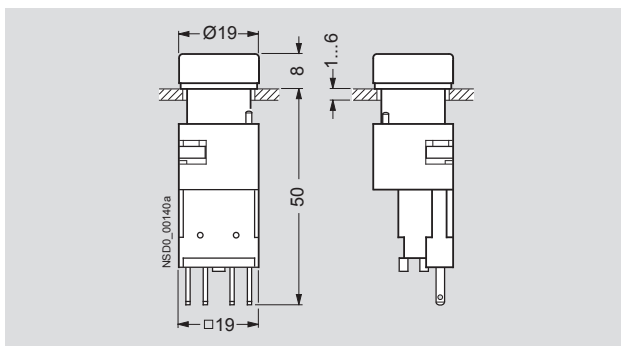

Push button (flat) with holder and contact block

If a command point is fitted with an indicator light or illuminated push button, a lamp socket with lamp holder must be used instead of a holder. It is suitable for incandescent lamps or LEDs with bases of type W2 × 4.6d.

For PCB mounting

The command point comprises the actuator – e.g. 3SB2 push button, illuminated push button or indicator light –, which is mounted in the front plate, and a contact block and a lamp holder which are soldered to the PCB. For this purpose, the contact blocks and lamp holders are fitted with 0.8 mm × 0.8 mm solder pins of length 3.5 mm.

Mounting and fixing:

Mounting dimensions according to EN 50007.

The actuators are mounted in the same way as 3SB2 front plate mounting devices.

The contact blocks and lamp holders are plugged into the printed circuit board by means of their solder pins and can be flow-soldered. After soldering, the devices must be flush with the board and perpendicular to it. The printed circuit board must be supported on spacing bolts so that it cannot sag or bend more than 0.1 mm.

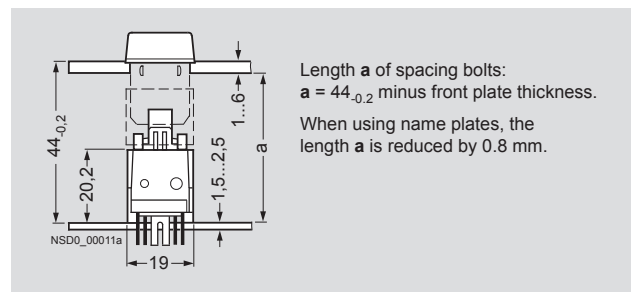

Illuminated push button with solder pin connection

To avoid bending the PCB when the control device is operated, sufficient spacing bolts must be provided as shown in the table below:

PCB thickness	Max. distance between spacing bolts
1.5 mm	80 mm
2.5 mm	150 mm
When using EMERGENCY-STOP push buttons	always 50 mm

These details are based on epoxy resin glass fiber mat.

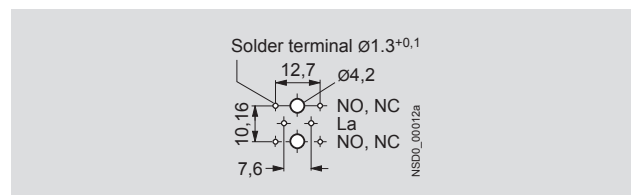

Solder pin spacing





Push Button Units and Indicator Lights

3SB2, Mounting Diameter 16 mm

Complete units

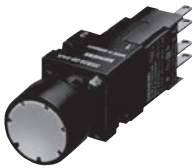
1
2
3
4
5
6
7
8
9
10

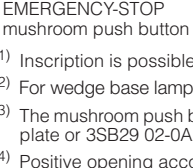
Selection and ordering data

	Version	Contact blocks	DT	Color of handle	Flat connectors	PS		
					Order No.			
 <p>Pushbutton with flat button</p>	Push buttons with flat button	1 NO		Black	3SB22 02-0AB01	1 unit		
		1 NC		Black	3SB22 03-0AB01	1 unit		
		1 NC		Red	3SB22 03-0AC01	1 unit		
		1 NO		Yellow	3SB22 02-0AD01	1 unit		
		1 NO		Green	3SB22 02-0AE01	1 unit		
		1 NO		Blue	3SB22 02-0AF01	1 unit		
		1 NO		White	3SB22 02-0AG01	1 unit		
		1 NO		Clear ¹⁾	3SB22 02-0AH01	1 unit		
		 <p>Illuminated push button with raised button</p>	Illuminated push buttons with flat button Lamp holder W2 x 4.6 d ²⁾	1 NC		Red	3SB22 07-0AC01	1 unit
				1 NO		Yellow ¹⁾	3SB22 06-0AD01	1 unit
1 NO				Green	3SB22 06-0AE01	1 unit		
1 NO				Blue	3SB22 06-0AF01	1 unit		
1 NO				Clear ¹⁾	3SB22 06-0AH01	1 unit		
 <p>Illuminated push button with raised button</p>	Illuminated push buttons with flat button Lamp holder W2 x 4.6 d with incandescent lamp 24 V	1 NC		Red	3SB22 27-0AC01	1 unit		
		1 NO		Yellow ¹⁾	3SB22 26-0AD01	1 unit		
		1 NO		Green	3SB22 26-0AE01	1 unit		
		1 NO		Blue	3SB22 26-0AF01	1 unit		
		1 NO		Clear ¹⁾	3SB22 26-0AH01	1 unit		
 <p>EMERGENCY-STOP mushroom push button</p>	Push buttons with raised button	1 NO		Black	3SB22 02-0LB01	1 unit		
		1 NC		Red	3SB22 03-0LC01	1 unit		
		1 NO		Yellow	3SB22 02-0LD01	1 unit		
		1 NO		Blue	3SB22 02-0LF01	1 unit		
		1 NO		Clear ¹⁾	3SB22 02-0LH01	1 unit		
		 <p>EMERGENCY-STOP mushroom push button</p>	Illuminated push buttons with raised button Lamp holder W2 x 4.6 d ²⁾	1 NC		Red	3SB22 07-0LC01	1 unit
				1 NO		Yellow ¹⁾	3SB22 26-0LD01	1 unit
				1 NO		Green	3SB22 06-0LE01	1 unit
				1 NO		Blue	3SB22 06-0LF01	1 unit
				1 NO		Clear ¹⁾	3SB22 06-0LH01	1 unit
 <p>EMERGENCY-STOP mushroom push button</p>	Illuminated push buttons with raised button Lamp holder W2 x 4.6 d with incandescent lamp 24 V	1 NC		Red	3SB22 27-0LC01	1 unit		
		1 NO		Yellow ¹⁾	3SB22 26-0LD01	1 unit		
		1 NO		Green	3SB22 26-0LE01	1 unit		
		1 NO		Blue	3SB22 26-0LF01	1 unit		
		1 NO		Clear ¹⁾	3SB22 26-0LH01	1 unit		
		1 NC	⊕ ⁴⁾	Red	3SB22 03-1AC01	1 unit		

¹⁾ Inscription is possible by inserting a label.

²⁾ For wedge base lamps see "Accessories", page 10/18.





³⁾ The mushroom push button cannot be combined with 3SB29 02-0AB name plate or 3SB29 02-0AA single frame.





⁴⁾ Positive opening according to IEC 60947-5-1, Appendix K.

Push Button Units and Indicator Lights

3SB2, Mounting Diameter 16 mm

Complete units

Version	Contact blocks	Color of handle	DT	Flat connectors	PS
Order No.					
 <p>Selector switch</p>	Selector switches, 2 switch positions Switching sequence O-I, 62° operating angle, maintained 	1 NO 1 NO 1 NO 1 NO	Black Red Green White	3SB22 02-2AB01 3SB22 02-2AC01 3SB22 02-2AE01 3SB22 02-2AG01	1 unit 1 unit 1 unit 1 unit
	Selector switches, 3 switch positions Switching sequence I-O-II, 2 × 62° operating angle, maintained 	1 NO, 1 NO 1 NO, 1 NO 1 NO, 1 NO 1 NO, 1 NO	Black Red Green White	3SB22 10-2DB01 3SB22 10-2DC01 3SB22 10-2DE01 3SB22 10-2DG01	1 unit 1 unit 1 unit 1 unit
	Selector switches, 3 switch positions Switching sequence I-O-II, 2 × 50° operating angle, momentary, Spring return from left and right 	1 NO, 1 NO 1 NO, 1 NO 1 NO, 1 NO 1 NO, 1 NO	Black Red Green White	3SB22 10-2EB01 3SB22 10-2EC01 3SB22 10-2EE01 3SB22 10-2EG01	1 unit 1 unit 1 unit 1 unit
	Order No.				

Version	Contact blocks	Lock No.	Key removal position	DT	Flat connectors	PS
Order No.						
 <p>CES key-operated switch</p>	CES key-operated switches, 2 switch positions Switching sequence O-I, 62° operating angle, maintained 	1 NO 1 NO	SB2 SB2	O O + I	3SB22 02-4LA01 3SB22 02-4LB01	1 unit 1 unit
	CES key-operated switches, 3 switch positions Switching sequence I-O-II, 2 × 62° operating angle, maintained 	1 NO, 1 NO 1 NO, 1 NO	SB2 SB2	O I + O + II	3SB22 10-4PA01 3SB22 10-4PB01	1 unit 1 unit
	CES key-operated switches, 3 switch positions Switching sequence I-O-II, 2 × 50° operating angle, momentary, Spring return from left and right 	1 NO, 1 NO	SB2	O	3SB22 10-4QA01	1 unit
Order No.						

Version	Color of screw lens	DT	Flat connectors	PS
Order No.				
 <p>Indicator light</p>	Indicator lights Lamp holder W2 x 4.6 d without lamp ¹⁾	Red Yellow Green White Clear	3SB22 04-6BC06 3SB22 04-6BD06 3SB22 04-6BE06 3SB22 04-6BG06 3SB22 04-6BH06	1 unit 1 unit 1 unit 1 unit 1 unit
	Indicator lights Lamp holder W2 x 4.6 d with incandescent lamp 24 V	Red Yellow Green White Clear	3SB22 24-6BC06 3SB22 24-6BD06 3SB22 24-6BE06 3SB22 24-6BG06 3SB22 24-6BH06	1 unit 1 unit 1 unit 1 unit 1 unit

¹⁾ For wedge base lamps see "Accessories", page 10/18.



Push Button Units and Indicator Lights

3SB2, Mounting Diameter 16 mm

Actuators and indicators

1
2
3
4
5
6
7
8
9
10

Selection and ordering data

Version	Color of handle	DT	Order No.	PS
Push buttons				
 Push button and illuminated push button with flat button	Push buttons with flat button	Black	3SB20 00-0AB01	1 unit
		Red	3SB20 00-0AC01	1 unit
		Yellow	3SB20 00-0AD01	1 unit
		Green	3SB20 00-0AE01	1 unit
		Blue	3SB20 00-0AF01	1 unit
		White	3SB20 00-0AG01	1 unit
		Clear ¹⁾	3SB20 00-0AH01	1 unit
 Push button and illuminated push button with raised button	Illuminated push buttons with flat button	Red	3SB20 01-0AC01	1 unit
		Yellow ¹⁾	3SB20 01-0AD01	1 unit
		Green	3SB20 01-0AE01	1 unit
		Blue	3SB20 01-0AF01	1 unit
		White	3SB20 00-0AG01	1 unit
		Clear ¹⁾	3SB20 00-0AH01	1 unit
 EMERGENCY-STOP mushroom push button	Push buttons with raised button	Black	3SB20 00-0LB01	1 unit
		Red	3SB20 00-0LC01	1 unit
		Yellow	3SB20 00-0LD01	1 unit
		Blue	3SB20 00-0LF01	1 unit
		White	3SB20 00-0LG01	1 unit
		Clear ¹⁾	3SB20 00-0LH01	1 unit
	Illuminated push buttons with raised button	Red	3SB20 01-0LC01	1 unit
	Yellow ¹⁾	3SB20 01-0LD01	1 unit	
	Green	3SB20 01-0LE01	1 unit	
	Blue	3SB20 01-0LF01	1 unit	
	Clear ¹⁾	3SB20 00-0LH01	1 unit	
	EMERGENCY-STOP mushroom push buttons acc. to ISO 13850, maintained²⁾ Latches automatically when pressed; unlatches by turning the mushroom head anticlockwise	Red	3SB20 00-1AC01	1 unit

¹⁾ Inscription is possible by inserting a label.







²⁾ The mushroom push button cannot be combined with 3SB29 02-0AB name plate or 3SB29 02-0AA single frame.

Version	Color of handle	DT	Order No.	PS
---------	-----------------	----	-----------	----

Selector switches



Selector switch

	Selector switches with 2 switch positions Switching sequence O-I, 62° operating angle, maintained		Black Red Green White	3SB20 00-2AB01 3SB20 00-2AC01 3SB20 00-2AE01 3SB20 00-2AG01	1 unit 1 unit 1 unit 1 unit
	Selector switches with 2 switch positions Switching sequence O-I, 50° operating angle, momentary, spring return from right		Black Red Green	3SB20 00-2BB01 3SB20 00-2BC01 3SB20 00-2BE01	1 unit 1 unit 1 unit
	Selector switches with 2 switch positions Switching sequence O-I, 90° operating angle, maintained		Black Red Green White	3SB20 00-2HB01 3SB20 00-2HC01 3SB20 00-2HE01 3SB20 00-2HG01	1 unit 1 unit 1 unit 1 unit
	Selector switches with 3 switch positions Switching sequence I-O-II, 2 x 62° operating angle, maintained		Black Red Green White	3SB20 00-2DB01 3SB20 00-2DC01 3SB20 00-2DE01 3SB20 00-2DG01	1 unit 1 unit 1 unit 1 unit
	Selector switches with 3 switch positions Switching sequence I-O-II, 2 x 50° operating angle, momentary, spring return from left and right		Black Red Green White	3SB20 00-2EB01 3SB20 00-2EC01 3SB20 00-2EE01 3SB20 00-2EG01	1 unit 1 unit 1 unit 1 unit
	Selector switches with 3 switch positions Switching sequence I-O-II, 2 x 90° operating angle, maintained		Black	3SB20 00-2JB01	1 unit

Push Button Units and Indicator Lights

3SB2, Mounting Diameter 16 mm

Actuators and indicators

Version	Lock No.	Key removal position	DT	Order No.	PS
---------	----------	----------------------	----	-----------	----

Key-operated switches



CES key-operated switch

<p>CES key-operated switches with 2 keys, 2 switch positions Switching sequence O-I, 62° operating angle, maintained</p> <p>CES key-operated switches with 2 keys, 2 switch positions Switching sequence O-I, 50° operating angle, momentary, spring return from right</p> <p>CES key-operated switches with 2 keys, 3 switch positions Switching sequence I-O-II, 2 x 62° operating angle, maintained</p> <p>CES key-operated switches with 2 keys, 3 switch positions Switching sequence I-O-II, 2 x 50° operating angle, momentary, spring return from left and right</p>		SB2	O+I O	3SB20 00-4LB01 3SB20 00-4LA01	1 unit 1 unit
		SB2	O	3SB20 00-4MA01	1 unit
		SB2	I+O+II O	3SB20 00-4PB01 3SB20 00-4PA01	1 unit 1 unit
		SB2	O	3SB20 00-4QA01	1 unit

Version	Color of screw lens	DT	Order No.	PS
---------	---------------------	----	-----------	----

Indicator lights



Indicator light

<p>Indicator lights with concentric rings (inscription by inserting a cap is not possible)</p> <p>Indicator lights, smooth for inscription by inserting a cap¹⁾</p>	Red	3SB20 01-6BC06	1 unit
	Yellow	3SB20 01-6BD06	1 unit
	Green	3SB20 01-6BE06	1 unit
	Blue	3SB20 01-6BF06	1 unit
	White	3SB20 01-6BG06	1 unit
	Clear	3SB20 01-6BH06	1 unit
	Red	3SB20 01-6CC06	1 unit
	Yellow	3SB20 01-6CD06	1 unit
	Green	3SB20 01-6CE06	1 unit
	Blue	3SB20 01-6CF06	1 unit
Clear	3SB20 01-6CH06	1 unit	

¹⁾ Insert caps, see "Accessories", page 10/15



Push Button Units and Indicator Lights

3SB2, Mounting Diameter 16 mm

Contact blocks and lampholders

1
2
3
4
5
6
7
8
9
10

Selection and ordering data

Version	Diagram	Operating travel  Contact closed  Contact open	DT	Flat connectors 	PS
				Order No.	

Contact blocks and lamp holders with flat connectors 2 x 2.8 – 0.8 mm according to IEC 60760

Holders for fixing the actuator and the contact blocks



Holder

Holders for 2 contact blocks
Inscription with identification number 1-2

3SB29 08-0AA 5 units

Lamp holders with holder for fixing the actuator and the contact blocks



Lamp holder

Lamp holders

W2 x 4.6 d
without lamp

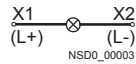

3SB23 04-2A 1 unit

Lamp holders

W2 x 4.6 d

- With 6 V incandescent lamp
- With 24 V incandescent lamp

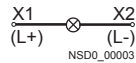

3SB23 04-2F 1 unit
3SB23 04-2H 1 unit

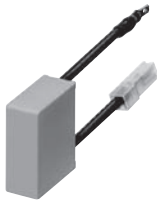

Voltage reducer

Voltage reducers¹⁾

For connecting the 3SB29 08-1AE lamp (48 V) to 230 V AC

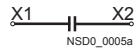

3SB24 04-3D 1 unit

Contact blocks for fixing in the holder or lamp holder

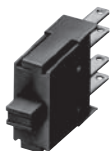

Contact block

Contact blocks with one contact²⁾

1 NO

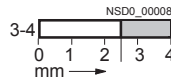

3SB24 04-0B 1 unit

1 NC ³⁾

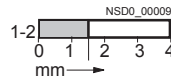

3SB24 04-0C 1 unit

¹⁾ Use fixpoint terminal according to IEC 60439-1.

²⁾ For plug-in and insulation sleeves see "Accessories", page 10/19.

³⁾ Positive opening according to IEC 60947-5-1, Appendix K.

Push Button Units and Indicator Lights

3SB2, Mounting Diameter 16 mm

Contact blocks and lamp holders

Version	Diagram	Operating travel <input type="checkbox"/> Contact closed <input type="checkbox"/> Contact open	DT	Solder pin connections	PS
---------	---------	--	----	------------------------	----

Order No.

Contact blocks and lamp holders with solder pins



Holder

Holders for contact block with solder pins

For fixing the actuators in the front panel

Lamp holders
Wedge base W2 x 4.6 d¹⁾



3SB29 08-0AB 5 units

3SB24 55-2A 1 unit

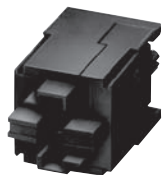

Contact block with solder pins

Contact blocks

1 NO

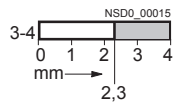

3SB24 55-0B 1 unit

1 NC

⊖²⁾

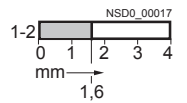

3SB24 55-0C 1 unit

1 NO + 1 NC

⊖²⁾

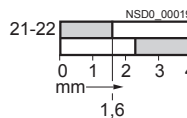

3SB24 55-0J 1 unit

1 NO + 1 NO

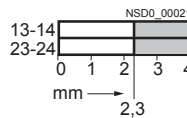

3SB24 55-0E 1 unit

1 NC + 1 NC

⊖²⁾

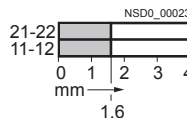

3SB24 55-0F 1 unit

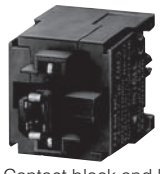

Contact block and lamp holder with solder pins

Contact blocks and lamp holders, wedge base W2 x 4.6 d¹⁾

1 NO

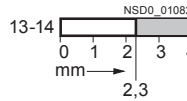

3SB24 55-1B 1 unit

1 NC

⊖²⁾

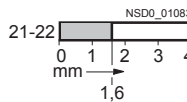

3SB24 55-1C 1 unit

1 NO + 1 NC

⊖²⁾

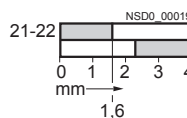

3SB24 55-1J 1 unit

1 NO + 1 NO

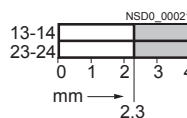

3SB24 55-1E 1 unit

1 NC + 1 NC

⊖²⁾

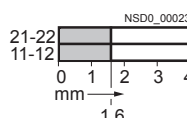

3SB24 55-1F 1 unit

¹⁾ The lamp is not included in the scope of supply.

Push Button Units and Indicator Lights

3SB2, Mounting Diameter 16 mm

Insert labels and insert caps

1

2

3

4

5

6

7

8

9

10

Overview

Clear push buttons, illuminated push buttons and indicator lights can be fitted with insert labels and caps for identification purposes.

The insert labels and insert caps are made of a milky-transparent plastic with black lettering; they can be fitted in any 90° angle.

Inscriptions

The inscriptions have upper case initial letters. Graphic symbols, including those not listed in the catalog, are according to ISO 7000 or IEC 60417.

For customized inscriptions see "Options".

Selection and ordering data

Inscription/Symbol	Symbol No.	DT	Insert labels For push buttons and illuminated push buttons, flat Order No.	PS
--------------------	------------	----	---	----

For self-inscription



Blank

3SB29 01-4AA

10 units

With inscription



On
Start
Stop
Reset
Test

3SB29 01-4EB
3SB29 01-4EK
3SB29 01-4EL
3SB29 01-4EM
3SB29 01-4EN

10 units
10 units
10 units
10 units
10 units

0
1
2
3
4
5
6
7
8
9

3SB29 01-4RA
3SB29 01-4RB
3SB29 01-4RC
3SB29 01-4RD
3SB29 01-4RE
3SB29 01-4RF
3SB29 01-4RG
3SB29 01-4RH
3SB29 01-4RJ
3SB29 01-4RK

10 units
10 units
10 units
10 units
10 units
10 units
10 units
10 units
10 units
10 units

Graphic ON/OFF symbols



O (Off)



5008 IEC

3SB29 01-4MB

10 units

I (On)



5007 IEC

3SB29 01-4MC

10 units

II (On)



--























3SB29 01-4MD

10 units

Push Button Units and Indicator Lights

3SB2, Mounting Diameter 16 mm

Insert labels and insert caps

Inscription/Symbol	Symbol No.	DT	Insert labels For push buttons and illuminated push buttons, flat Order No.	PS
Graphic equipment symbols				
 Electric motor	 0011 ISO		3SB29 01-4PA	10 units
Horn	 5014 IEC		3SB29 01-4PB	10 units
Pump	 0134 ISO		3SB29 01-4PD	10 units
Coolant pump	 0355 ISO		3SB29 01-4PE	10 units
Graphic motion symbols				
 Motion in direction of arrow (straight)	 5022 IEC		3SB29 01-4NA	10 units
Motion in direction of arrow (diagonal)	 --		3SB29 01-4NB	10 units
Clockwise rotation	 0004 ISO		3SB29 01-4NC	10 units
Anticlockwise rotation	 --		3SB29 01-4ND	10 units
Fast motion	 0266 ISO		3SB29 01-4NE	10 units
Increase (plus)	 5005 IEC		3SB29 01-4NG	10 units
Decrease (minus)	 5006 IEC		3SB29 01-4MC	10 units
Graphic control symbols				
 Clamp	 --		3SB29 01-4QB	10 units
Release	 --		3SB29 01-4QC	10 units
Brake off	 0021 ISO		3SB29 01-4QE	10 units
Lock	 0022 ISO		3SB29 01-4QF	10 units
Unlock	 0023 ISO		3SB29 01-4QG	10 units
On/Off, momentary contact	 5011 IEC		3SB29 01-4QJ	10 units
Manual operation	 0096 ISO		3SB29 01-4QK	10 units
Automatic sequence	 0017 ISO		3SB29 01-4QL	10 units
Customized inscriptions				
 Any inscription 1 line of text with up to 6 characters of 3 mm in height. Please add the appropriate order code to the Order No. and specify the line of text required.			3SB29 01-4AZ K0Y K1Y or K2Y K5Y	1 unit 1 unit 1 unit
Other graphic symbols Please add the order code "K3Y" to the Order No. and specify the serial number and the applied standard (ISO 7000 or IEC 60417).			3SB29 01-4AZ K3Y	1 unit
Any inscription or symbol Please add the order code "K9Y" to the Order No. and specify the inscription or the symbol required.			3SB29 01-4AZ K9Y	1 unit

Push Button Units and Indicator Lights

3SB2, Mounting Diameter 16 mm

Insert labels and insert caps

1
2
3
4
5
6
7
8
9
10

Inscription/Symbol	Symbol No.	DT	Insert caps For push buttons and illuminated push buttons, raised Order No.	PS
--------------------	------------	----	---	----





For self-inscription

	Blank		3SB29 01-5AA	10 units
---	-------	--	---------------------	----------





With inscription

	On		3SB29 01-5EB	10 units
	0		3SB29 01-5RA	10 units
	1		3SB29 01-5RB	10 units
	2		3SB29 01-5RC	10 units
	3		3SB29 01-5RD	10 units
	4		3SB29 01-5RE	10 units
	5		3SB29 01-5RF	10 units
	6		3SB29 01-5RG	10 units
	7		3SB29 01-5RH	10 units
	8		3SB29 01-5RJ	10 units
	9		3SB29 01-5RK	10 units

Graphic ON/OFF symbols

	O (Off)		5008 IEC	3SB29 01-5MB	10 units
	I (On)		5007 IEC	3SB29 01-5MC	10 units
	II (On)		--	3SB29 01-5MD	10 units

Graphic motion symbols

	Motion in direction of arrow		5022 IEC	3SB29 01-5NA	10 units
	Motion in direction of arrow		--	3SB29 01-5NB	10 units
	Increase (plus)		5005 IEC	3SB29 01-5NG	10 units
	Decrease (minus)		5006 IEC	3SB29 01-5MC	10 units

Graphic control symbols

	Clamp		--	3SB29 01-5QB	10 units
	Release		--	3SB29 01-5QC	10 units







Customized inscriptions

	Any inscription 1 line of text with up to 6 characters of 3 mm in height. Please add the appropriate order code to the Order No. and specify the line of text required.			3SB29 01-5AZ K0Y K1Y or K2Y K5Y	1 unit 1 unit 1 unit
	Other graphic symbols Please add the order code " K3Y " to the Order No. and specify the serial number and the applied standard (ISO 7000 or IEC 60417).			3SB29 01-5AZ K3Y	1 unit
	Any inscription or symbol Please add the order code " K9Y " to the Order No. and specify the inscription or the symbol required.			3SB29 01-5AZ K9Y	1 unit

Push Button Units and Indicator Lights

3SB2, Mounting Diameter 16 mm

Insert labels and insert caps

Inscription/Symbol	Symbol No.	DT	Insert caps For indicator lights Order No.	PS
For self-inscription				
 Blank			3SB29 01-7AA	10 units
Graphic symbols				
 Pump		 0134 ISO	3SB29 01-7PD	10 units
 Manual operation		 0096 ISO	3SB29 01-7QK	10 units
Customized inscriptions				
	Any inscription 1 line of text with up to 6 characters of 3 mm in height. Please add the appropriate order code to the Order No. and specify the line of text required.		3SB29 01-7AZ K0Y K1Y or K2Y K5Y	1 unit 1 unit 1 unit
	Other graphic symbols Please add the order code " K3Y " to the Order No. and specify the serial number and the applied standard (ISO 7000 or IEC 60417).		3SB29 01-7AZ K3Y	1 unit
	Any inscription or symbol Please add the order code " K9Y " to the Order No. and specify the inscription or the symbol required.		3SB29 01-7AZ K9Y	1 unit

Options

Customized inscriptions

Labels and caps can be inscribed with text and symbols not listed in the ordering data. Append the following codes to the Order No.:

- Text line in upper/lower case, always upper case for beginning of line (e.g. "Lift"): **K0Y**
- Text line in upper case (e.g. "LIFT"): **K1Y**
- Text line in lower case (e.g. "lift"): **K2Y**
- Text line in upper/lower case, all words begin with upper case letters (e.g. "Lift"): **K5Y**
- Symbol with number according to ISO 7000 or IEC 60417: **K3Y**
- Any inscription or symbols according to order form supplement: **K9Y**

When ordering, specify the required inscription in plain text in addition to the order number and order code. In the case of special inscriptions with words in languages other than German, give the exact spelling and specify the language.

One line with up to 6 characters with 3 mm letter height is possible for the inscription (see ordering example 1).

Symbols can also be ordered with numbers according to ISO 7000 or IEC 60417 (see ordering examples 2 and 3).

For special symbols (order code K9Y), a CAD drawing in DXF format can be submitted.

Ordering example 1

3SB29 01-4AZ
K1Y
Z = pump

Ordering example 2

3SB29 01-4AZ
K3Y
Z = 5008 IEC

Ordering example 3

3SB29 01-4AZ
K3Y
Z = 1118 ISO

Push Button Units and Indicator Lights

3SB2, Mounting Diameter 16 mm

Name plates

1
2
3
4
5
6
7
8
9
10

Overview





The name plates consist of a black plastic label holder and an inscription label (silver with black print) for sticking in place.

Note mounting dimensions!

Inscriptions

The inscriptions (also special inscriptions) are lower case with upper case initial letters. Graphic symbols, including those not listed in the catalog, are according to ISO 7000 or IEC 60417.

Selection and ordering data

Inscription/Symbol	Symbol No.	DT	Order No.	PS
Inscription labels, self-adhesive, 9.5 mm x 18.5 mm				
 Blank			3SB29 01-2AA	10 units
On			3SB29 01-2EB	10 units
Off			3SB29 01-2EC	10 units
Start			3SB29 01-2EL	10 units
Reset			3SB29 01-2EM	10 units
Fault			3SB29 01-2EW	10 units
Hand Auto			3SB29 01-2BA	10 units
Manual 0 Auto			3SB29 01-2BE	10 units
Man 0 Auto			3SB29 01-2ET	10 units
Graphic symbols				
O (Off)		5008 IEC	3SB29 01-2MB	1 unit
I (On)		5007 IEC	3SB29 01-2MC	1 unit
O I (horizontal)		--	3SB29 01-2MF	1 unit
Motion in direction of arrow		5002 IEC	3SB29 01-2NA	1 unit
Customized inscriptions or symbols				
(see Options)			3SB29 01-2XZ	
			K0Y	1 unit
			K1Y, K2Y or K3Y	1 unit
			K5Y	1 unit
			K9Y	1 unit

Label holders



Label holders for inscription labels

The label holders must not be used with the 3SB2...-1AC01 EMERGENCY-STOP mushroom push button.

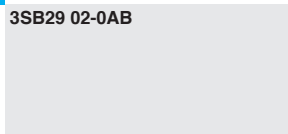
	3SB29 02-0AB	1 unit
---	---------------------	--------

Options

Customized inscriptions

The labels can be inscribed with text and symbols not listed in the ordering data. Append the following codes to the Order No.:

- Text line(s) in upper/lower case, upper case always for beginning of line (e.g. "Lift off"): **K0Y**
- Text line(s) in upper case (e.g. "LIFT OFF"): **K1Y**
- Text line(s) in lower case (e.g. "lift off"): **K2Y**
- Text line(s) in upper/lower case, all words begin with upper case letters (e.g. "Lift Off"): **K5Y**
- Symbol with number according to ISO 7000 or IEC 60417: **K3Y**
- Any inscription or symbols according to order form supplement: **K9Y**

When ordering, specify the required inscription in plain text in addition to the order number and order code. In the case of special inscriptions with words in languages other than German, give the exact spelling and specify the language.

Two lines of 11 characters are permitted with 4 mm letter height (1 line) or 3 mm (2-line).

Symbols can also be ordered with numbers according to ISO 7000 or IEC 60417 (see ordering example).

For special symbols (order code K9Y), a CAD drawing in DXF format can be submitted.

Ordering example











3SB29 01-2XZ
K3Y
Z = 1118 ISO

Push Button Units and Indicator Lights

3SB2, Mounting Diameter 16 mm

Mounting parts and components

Selection and ordering data

Version	Lamp voltage	Color	DT	Order No.	PS
V					
Buttons and lenses¹⁾					
 3SB29 10-0AF	Buttons, flat For push buttons	Black		3SB29 10-0AB	1 unit
		Red		3SB29 10-0AC	1 unit
		Yellow		3SB29 10-0AD	1 unit
		Green		3SB29 10-0AE	1 unit
		Blue		3SB29 10-0AF	1 unit
		White		3SB29 10-0AG	1 unit
		Clear		3SB29 10-0AH	1 unit
 3SB29 10-0CF	Buttons, flat For illuminated push buttons	Red		3SB29 10-0CC	1 unit
		Yellow		3SB29 10-0CD	1 unit
		Green		3SB29 10-0CE	1 unit
		Blue		3SB29 10-0CF	1 unit
		White		3SB29 10-0AG	1 unit
		Clear		3SB29 10-0AH	1 unit
		 3SB29 10-0BD	Buttons, raised For push buttons	Black	
Red				3SB29 10-0BC	1 unit
Yellow				3SB29 10-0BD	1 unit
Clear				3SB29 10-0BH	1 unit
 3SB29 10-0DD	Buttons, raised For illuminated push buttons	Red		3SB29 10-0DC	1 unit
		Yellow		3SB29 10-0DD	1 unit
		Clear		3SB29 10-0BH	1 unit
 3SB29 10-1AD	Screw lenses With concentric rings	Red		3SB29 10-1AC	1 unit
		Yellow		3SB29 10-1AD	1 unit
		Green		3SB29 10-1AE	1 unit
		Blue		3SB29 10-1AF	1 unit
		White		3SB29 10-1AG	1 unit
		Clear		3SB29 10-1AH	1 unit
 3SB29 10-1BE	Screw lenses Smooth, for inscription with insert cap	Red		3SB29 10-1BC	1 unit
		Yellow		3SB29 10-1BD	1 unit
		Green		3SB29 10-1BE	1 unit
		Blue		3SB29 10-1BF	1 unit
		Clear		3SB29 10-1BH	1 unit
Key for actuators					
 3SB29 08-2AJ	Keys For CES key-operated switch, lock No. SB2			3SB29 08-2AJ	1 unit
Lamps, wedge bases²⁾					
 3SB29 08-1AE	Incandescent lamps Wedge base W2 × 4.6 d, 1.0 W	AC/DC	Clear		
		6		3SB29 08-1AA	1 unit
		12		3SB29 08-1AB	1 unit
		24		3SB29 08-1AC	1 unit
		30		3SB29 08-1AD	1 unit
		48		3SB29 08-1AE	1 unit
		60		3SB29 08-1AF	1 unit
 3SB39 01-1SB	LED lamps, super-bright Wedge base W2 × 4.6 d	24 AC/DC	Red	3SB39 01-1SB	1 unit
			Yellow	3SB39 01-1RB	1 unit
			Green	3SB39 01-1TB	1 unit
			White	3SB39 01-1UB	1 unit
			Blue	3SB29 08-1BD	1 unit
 3SB29 08-1BD		28 AC/DC	Red	3SB39 01-1SE	1 unit
			Yellow	3SB39 01-1RE	1 unit
			Green	3SB39 01-1TE	1 unit
			White	3SB39 01-1UE	1 unit
			Blue	3SB39 01-1VE	1 unit
 3SB29 08-1AB	Lamp extractors For lamps with bases W2 × 4.6 d			3SB29 08-2AB	1 unit

¹⁾ Included in the scope of supply of actuators or indicator lights.

²⁾ Included in the scope of supply of some complete units.

Push Button Units and Indicator Lights

3SB2, Mounting Diameter 16 mm

Mounting parts and components

1
2
3
4
5
6
7
8
9
10

Version	DT	Order No.	PS
---------	----	-----------	----

Accessories for command points



3SB29 02-0AA

Single frames for square design¹⁾

3SB29 02-0AA

1 unit



3SB29 08-2AG

Name plates, yellow, Ø 50 mm

As backing plate for EMERGENCY-STOP, self-adhesive

- Blank
- With German inscription "NOT-HALT"
- With German inscription "NOT-AUS"

3SB29 08-2AF
3SB29 08-2AG
3SB29 08-2AK

1 unit
1 unit
1 unit



3SB29 08-3AA

Blanking plugs

Black plastic
(degree of protection IP65)

3SB29 08-3AA

1 unit



3SB29 08-1

Protective caps, clear

Silicone, for push buttons with flat and raised button

3SB29 08-3AB

1 unit

Flat connectors



3SB29 08-8AA

Plug-in sleeves

For flat connectors 2.8 × 0.8 mm, cross-section 0.5 ... 1.5 mm²

3SB29 08-8AA

1 unit



3SB29 08-8AB

Insulation sleeves

For flat connectors, connection from the front

3SB29 08-8AB

1 unit



3SB29 08-8AD

Complete connectors²⁾

For connecting contact blocks and lamp holders
(up to 10 connections).
Guaranteed finger-safe acc. to IEC 61140 and BGV A3.

3SB29 08-8AD

1 unit



3SB29 08-8AE

Plug-in sleeves

For flat connectors 2.8 × 0.8 mm,
with locating spring for maintained in complete connector

3SB29 08-8AE

250 units

Tools



3SB29 08-2AA

Dismantling tools

For holders and lamp holders with holder

3SB29 08-2AA

1 unit



3SB29 08-2AC

Mounting tools

For buttons
and screw lenses

3SB29 08-2AC

1 unit

¹⁾ Not suitable for EMERGENCY-STOP mushroom push buttons.

²⁾ Required 3SB29 08-8AE plug-in sleeves for flat connectors 2.8 × 0.8 mm are not included in the scope of supply.

Push Button Units and Indicator Lights

3SB2, Mounting Diameter 16 mm

Dimension drawings (mm)

Actuators

Pushbutton or illuminated pushbutton with flat button

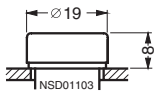

Pushbutton or illuminated pushbutton with raised button

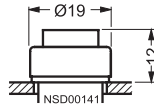

Selector switch

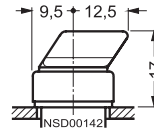

CES key-operated switch

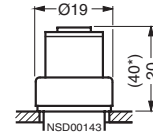

* with key

EMERGENCY-STOP mushroom pushbutton

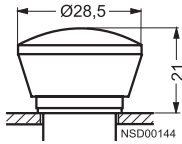

Indicator light

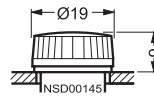

Contact blocks with push-on connection

Pushbutton and contact block with holder for frontplate mounting

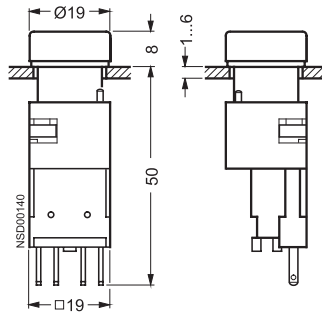

Contact blocks with soldering pins for use on printed circuit boards

Illuminated pushbutton unit with contact block and lamp-holder with solder pins

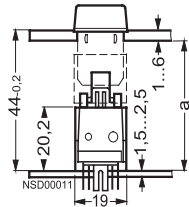

Length **a** of spacers: $a = 44 - 0.2$ minus front plate thickness.
When using backing plates, the length **a** is reduced by 0.8 mm.
To avoid bending of the PCB when the actuator is operated, sufficient spacers must be provided spaced as shown in the table below:

Maximum PCB thickness	Max. distance between spacers
1.5 mm	80 mm
2.5 mm	150 mm
When using EMERGENCY-STOP actuators	generally 50 mm

Solder pin spacing

Solder terminal $\varnothing 1.3^{+0.1}$

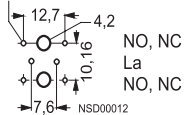

(These details are based on epoxy resin glass fibre mat.)

Mounting dimensions

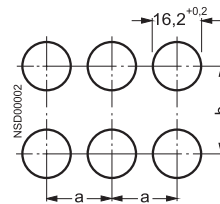

Minimum clearance	a	b
Round design	19	19
Square design without inscription plate	21	21
Round and square designs with 21 inscription plates		32
For 2 selector switches and 3 switching positions, maintained contact, side by side	21	21

Accessories

Complete connector

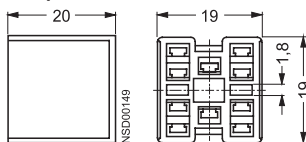

Push Button Units and Indicator Lights

3SB3 Push Buttons and Indicator Lights, 22 mm

General data

1
2
3
4
5
6
7
8
9
10

Overview

Front plate mounting

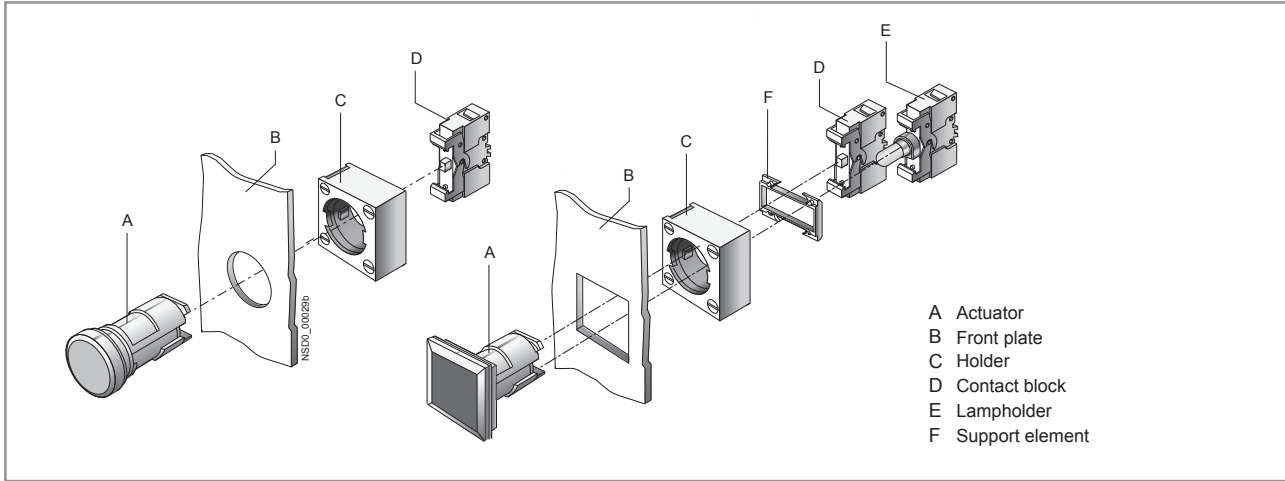

For actuators [see page 10/26 to 10/64](#).
 For contact blocks and lamp holders [see page 10/65 to 10/67](#).
 For holders [see page 10/68](#).

Mounting on printed circuit boards

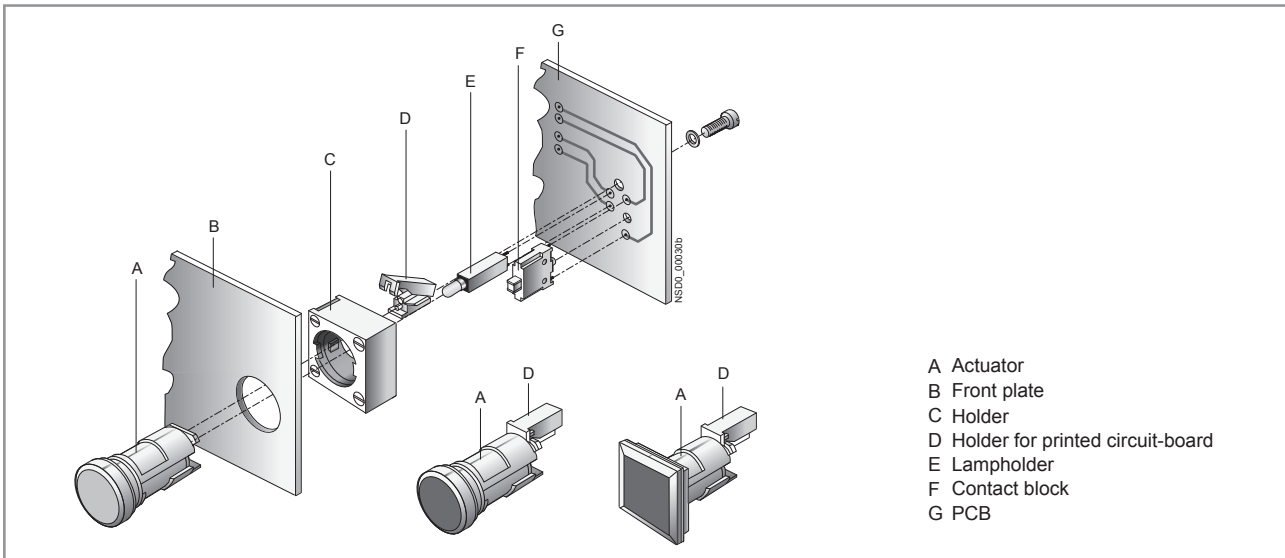

For contact blocks for use on printed circuit boards [see page 10/68](#).

Contact assignment

For one contact block with 2 contacts, e.g. 1 NO + 1 NC

For 2 contact blocks each with 1 contact, e.g. 1 NO, 1 NC

For 2 contact blocks each with 2 contacts, e.g. 1 NO + 1 NC, 1 NO + 1 NC

For one contact block with 2 contacts, e.g. 1 NO + 1 NC and a lampholder

Mounting surface depth
 Depth for contact blocks with 1 contact
 Depth for contact blocks with 2 contacts

Carrier for 3 blocks
 Contact blocks, lamp holders

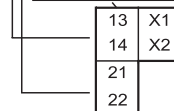
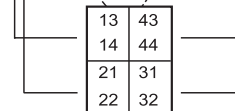
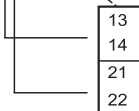
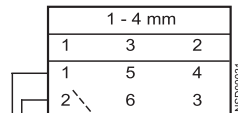
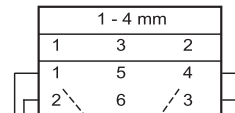
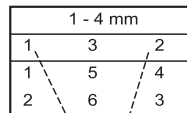
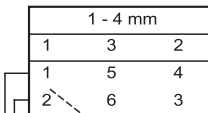

Push Button Units and Indicator Lights

3SB3 Push Buttons and Indicator Lights, 22 mm

General data

Design

The 3SB3 series is a modular range of commanding and signaling devices for front panel mounting and rear conductor connection. As an alternative, individual elements can also be supplied for use on printed circuit boards. Complete units are offered for the most commonly used applications.

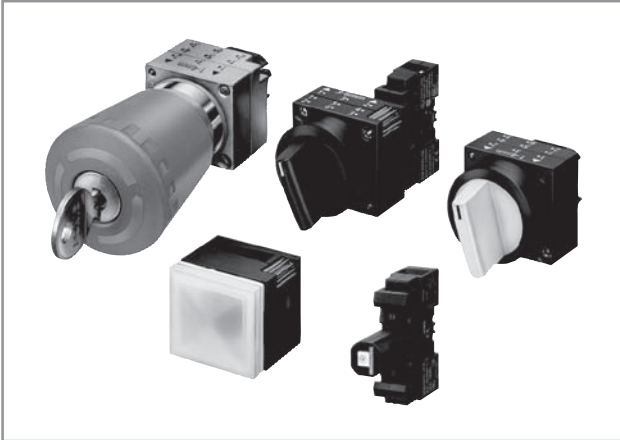

Actuators and indicators and complete units

The 3SB3 series is available:

- Made of molded plastic in flat, round and square design
- Made of metal in round design.

The devices are of modern industrial design and can be mounted rapidly by a single person. The operating surfaces of the push buttons and illuminated push buttons are concave. The lenses of the indicator lights are convex.

The metal version with a high degree of protection according to IP67 and NEMA 4X is available for the world market.

One command point comprises:

- An actuator or lens assembly in front of the control panel
- A holder for mounting behind the control panel
- Up to 3 contact blocks and/or 1 lamp holder behind the control panel
- A comprehensive range of accessories for inscription

Two contact blocks can be snapped onto the actuator in the standard version.

When three contact blocks or illuminated actuators are required, an additional holder must be plugged onto the actuator from the rear.

- 3SB39 01-0AB holder for 3 contact blocks or for 2 contact blocks and 1 lamp holder
- 3SB39 01-0AC holder with pressure plates for actuating a central contact block when using a selector switch, key-operated switch and twin push button with 3 contact blocks.

For illuminated push buttons, illuminated switches and illuminated selector switches the holder is included in the scope of supply as standard.



The contact blocks are fitted with slow-action contacts with double operating contacts. These ensure a high switching reliability even with small voltages and currents, such as 5 V/1 mA. They are suitable for use in solid-state systems as well as conventional controls.

Standards

IEC 60947-1, EN 60947-1,
IEC 60947-5-1, EN 60947-5-1,
IEC 60947-5-5, EN 60947-5-5 for EMERGENCY-STOP mushroom push buttons.

Connection methods

The devices are available with screw terminals (box terminals), spring-type terminals or solder pins.

-  Screw terminals
-  Spring-type terminals
-  Solder pin connections

The terminals are indicated in the corresponding tables by the symbols shown on blue backgrounds.

Application

The devices are climate-proof (KTW 24) and suitable for standard industrial applications and operation in marine applications. For operation in oily atmospheres (organic oils/lubricants) we recommend actuators which are marked as "solvent-resistant".

AS-Interface solutions

The 3SB3 commanding and signaling devices can be connected to the AS-Interface communication system quickly and safely with the help of various solutions.

The following solutions are available:

- ASIsafe EMERGENCY-STOP mushroom push buttons (see page 10/97)
- AS-Interface enclosures with 1 to 6 command points (see page 10/96).
- AS-Interface front panel modules for 4 command points (see Catalog IK PI)

"Intrinsic safety" type of protection EEx i according to ATEX directive 94/9/EC

The push buttons and indicator lights in round design can also be used in hazardous areas. The 3SB34 ...0. contact blocks and the 3SB34 ...1A lamp holders (with 3SB39 01-1.A LED lamp) with screw terminals or spring-type terminals can be used.

See www.siemens.com/sirius/atex.

Safety EMERGENCY-STOP push buttons according to ISO 13850

For controls according to IEC 60204-1 or EN 60204-1, the mushroom push buttons of the 3SB3 series are suitable for use as safety EMERGENCY-STOP push buttons.

Safety circuits

IEC 60947-5-1 and EN 60947-5-1 require positive opening, i.e. for the purposes of personal safety, the assured opening of NC contacts is expressly stipulated for the electrical equipment of machines in all safety circuits and marked according to IEC 60947-5-1 with the symbol .

Category 4 according to EN 954-1 can be attained with the EMERGENCY-STOP mushroom push buttons if the corresponding failsafe evaluation units are selected and correctly installed, e.g. the 3TK28 safety relays or matching units from the ASIsafe, SIMATIC or SINUMERIK product ranges.

Push Button Units and Indicator Lights

3SB3 Push Buttons and Indicator Lights, 22 mm

General data

1
2
3
4
5
6
7
8
9
10

Configuration

Mounting and fixing

The 3SB3 devices can be easily and quickly mounted:

- Actuators or indicator lights are positioned in the opening of the front panel from the front
- Position the holder from the rear
- Tighten the screw on the holder
- Snap on the contact block or the lamp holder directly onto the actuator from the back

The holder for the round versions is set to a switchboard thickness of 1 to 4 mm when delivered and is placed in the direction of the arrow \uparrow 1–4 mm \uparrow on the actuator/indicator from the back. The fixing screw is located underneath, on the right.

For a switchboard thickness of 3 to 6 mm, the holder is reversed and mounted in the direction of the arrow at \uparrow 3–6 mm \uparrow and the fixing screw is located on the upper right. In this case, the fixing screw must be rotated anticlockwise to its limit before mounting the holder.

The control panel depth of 1 to 4 mm can be compensated with the holder with the square version.

When label holders, protective caps or similar accessories are used, the greatest permissible control panel thickness must be reduced by the wall thickness of the accessory part.

Mounting dimensions on front plates

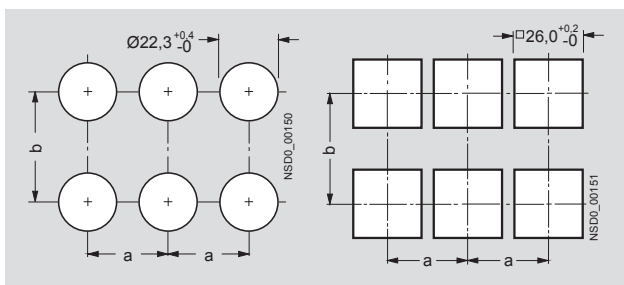

Minimum clearance	a	b
Contact blocks (1 contact) and lamp holder		
• For front plate mounting, with screw terminals	30 ¹⁾	45
• For front plate mounting with spring-type terminals	30 ¹⁾	30 ¹⁾
• For use on PCB, with solder pin connections	30 ¹⁾	30 ¹⁾
Contact blocks with 2 contacts		
• for front plate mounting	30 ¹⁾	50
When using holders for inscription labels		
• 12.5 mm × 27 mm	30 ¹⁾	45 ²⁾
• 27.0 mm × 27 mm	30 ¹⁾	60

¹⁾ For mushroom push button, EMERGENCY-STOP and push-pull button: Note mushroom diameter $d = 40$ mm or 60 mm.

²⁾ 60 mm with contact blocks having two contacts.

Mounting depth

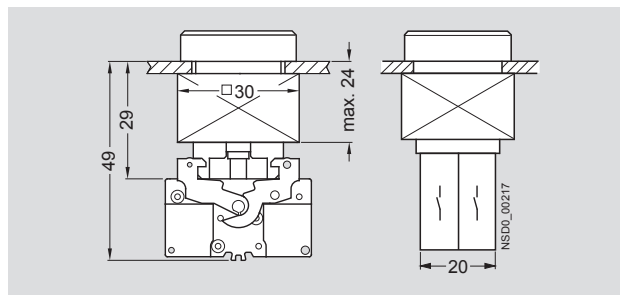

Push button with two contact blocks

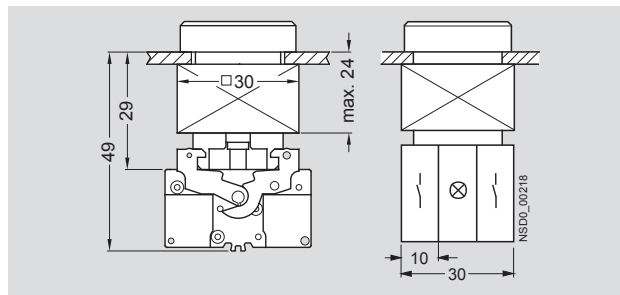

Illuminated push button with lamp holder and two contact blocks

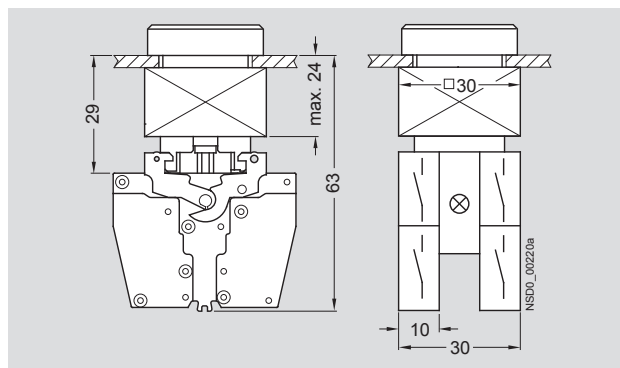

Illuminated push button with lamp holder and two contact blocks with two contacts

Used on printed circuit boards

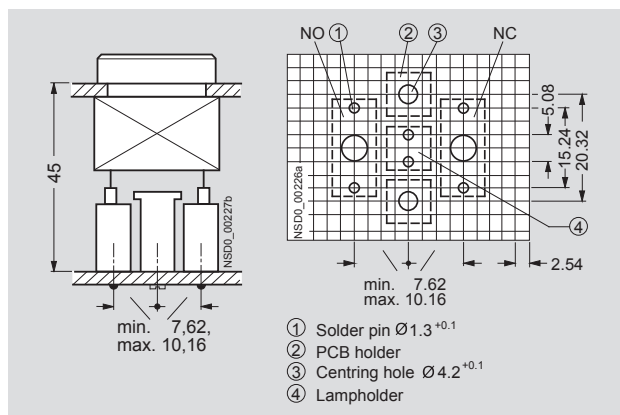



Illuminated push button with solder pins

Push Button Units and Indicator Lights

3SB3 Push Buttons and Indicator Lights, 22 mm

General data

Technical specifications

Type		3SB34 00-0, 3SB34 20-0	3SB14 00-0J	3SB34 00-1, 3SB34 20-1	3SB34 03-0, 3SB34 23-0	3SB34 03-1, 3SB34 23-1	3SB34 11-0	3SB34 11-1
Contact blocks and lamp holders								
Standards		IEC 60947-5-1, IEC 60947-5-5, EN 60947-5-1, EN 60947-5-5						
Connection type		 Screw terminals			 Spring-type terminals		 Solder pins	
Rated insulation voltage U_i	V	400		250	400		250	60
For pollution degree according to IEC 60947-1								
		Class 3		Class 3	Class 3		Class 3	Class 3
Rated impulse withstand voltage U_{imp}	kV	4		4	4	4	4	1.5
Conventional thermal current I_{th}	A	10		—	10	—	10	—
Rated operational current I_e at rated operational voltage U_e								
• Alternating current 50/60 Hz, AC-12								
- At $U_e = 24 \dots 230$ V	A	10		—	10	—	10	—
- At $U_e = 400$ V	A	10		—	10	—	10	—
• Alternating current 50/60 Hz, AC-15								
- At $U_e = 24 \dots 230$ V	A	6	6	—	6	—	4	—
- At $U_e = 400$ V	A	3	4	—	3	—	—	—
• Direct current DC-12								
- At $U_e = 24$ V	A	10	10	—	10	—	10	—
- At $U_e = 48$ V	A	5	—	—	5	—	5	—
- At $U_e = 110$ V	A	2.5	2	—	2.5	—	2.5	—
- At $U_e = 230$ V	A	1	0.5	—	1	—	1	—
• Direct current DC-13								
- At $U_e = 24$ V	A	3	5	—	3	—	3	—
- At $U_e = 48$ V	A	1.5	—	—	1.5	—	1.5	—
- At $U_e = 110$ V	A	0.7	0.5	—	0.7	—	0.7	—
- At $U_e = 230$ V	A	0.3	0.2	—	0.3	—	0.3	—
Contact stability								
• Test voltage	V	5	—	—	5	—	5	—
• Test current	mA	1	—	—	1	—	1	—
Lamp holders		—	—	BA 9s	—	BA 9s	—	Wedge bases
Lamps		—	—	Incandescent lamps, glow lamps and LED lamps	—	Incandescent lamps, glow lamps and LED lamps	—	Incandescent lamps and LED lamps
Short-circuit protection , weld-free, acc. to IEC 60947-5-1		Dz10 A						
• DIAZED fuse links, utilization category gG acc. to IEC 60269-3-1		Dz 16 A						
• DIAZED fuse links, quick according to DIN VDE 0635		10						
• Miniature circuit breaker with C characteristic according to IEC 60898	A	10						
Mechanical endurance		10 × 10 ⁶ operating cycles						
Electrical endurance		10 × 10 ⁶ operating cycles						
• For utilization category AC-15 with 3RT20 15 to 3RT20 26 contactors		10 × 10 ⁶ operating cycles						
• With utilization category DC-12, DC-13		With direct current it depends on the operational voltage, the breaking current, the circuit inductance and the switching frequency						
Switching frequency	1/h	1000 operating cycles						
Degree of protection acc. to IEC 60529		IP20						
• Connections		IP40		—	IP40	—	IP40	—
• Contact chambers		IP40		—	IP40	—	IP40	—
Touch protection according to EN 61140 and BGV A3		Finger-safe			Finger-safe		—	
Conductor cross-sections ¹⁾		—						
• Finely stranded, without end sleeves	mm ²	—		2 × (0.25 ... 1.5)		—		
• Finely stranded, with end sleeves to DIN 46228	mm ²	2 × (0.5 ... 1.5)		2 × (0.25 ... 0.75)		—		
• Solid	mm ²	2 × (1 ... 1.5)		2 × (0.25 ... 1.5)		—		
• Solid with end sleeves to DIN 46228	mm ²	2 × (0.5 ... 0.75)		—		—		
• AWG cables, solid or stranded		2 × AWG 18 ... 14		2 × AWG 24 ... 16		—		
Tightening torque , terminal screw	Nm	0.8		—		—		
Solder pins	mm ²	—		—		0.8 × 0.8		

¹⁾ For standard screwdriver size 2 or Pozidriv 2.

Push Button Units and Indicator Lights

3SB3 Push Buttons and Indicator Lights, 22 mm

General data

1

2

3

4

5

6

7

8

9

10

Type	3SB34 00-0, 3SB34 20-0	3SB34 00-1, 3SB34 20-1	3SB34 03-0, 3SB34 23-0	3SB34 03-1, 3SB34 23-1	3SB34 11-0	3SB34 11-1
Data according to UL and CSA						
Rated operational voltage	V AC 300	—	300	—	300	—
Conventional thermal current (uninterrupted current)	A 10	—	10	—	10	—
Switching capacity	A 300, R 300, A 600 same polarity					
Rated voltage (lamps)	<ul style="list-style-type: none"> Lamp with BA 9s base Lamp with wedge base Lamp holders with integrated LED 					
	V AC	—	125	—	125	—
	V AC	—	60	—	60	60
	V	—	24 AC/DC, 110 AC, 230 AC	—	24 AC/DC, 110 AC, 230 AC	—
Rated power (lamps)	W	—	2.5	—	2.5	1

Type	3SB30, 3SB32 (3SB31)	3SB31, 3SB33	3SB35, 3SB36
Actuators and indicators			
Enclosure material	Plastic		Metal
Design	Round	Square	Round
Terminal designation acc. to EN 50013	Identification number on the holder, function digit on the contact block		
Device identification	Snap-on label		
Tightening torques	<ul style="list-style-type: none"> Screw on holder 		
	Nm	max. 1	
Mechanical endurance	<ul style="list-style-type: none"> Push buttons Illuminated push buttons Actuators, rotary or maintained Key-operated switch with key monitoring 		
		<ul style="list-style-type: none"> 10 × 10⁶ operating cycles 3 × 10⁶ operating cycles 3 × 10⁵ operating cycles 1 × 10⁵ operating cycles 	
Switching frequency	1/h	1000 operating cycles	
Climatic withstand capability acc. to EN ISO 6270-2	Climate-proof KTW24; suitable for marine applications		
Ambient temperature	<ul style="list-style-type: none"> During operation, non-illuminated and with LED During operation, devices with incandescent lamp During storage, transport 		
	°C	-25 ... +70	
	°C	-25 ... +60	
	°C	-40 ... +80	
Degree of protection acc. to IEC 60529 and NEMA Standards	<ul style="list-style-type: none"> Actuators and indicators, standard - with protective caps Key-operated switch with key monitoring Twin push buttons (3SB31) 		
		IP66; NEMA Type 1,3,4,4X, 12 IP67; NEMA Type 1,3,4,4X, 12 IP54; NEMA Type 1,3,4,4X, 12 IP65; NEMA Type 1,3,4,4X, 12	IP65; NEMA Type 1,3,4,4X, 12 IP67; NEMA Type 1,3,4,4X, 12 — —
Protective measures	Protective measures are met automatically when the actuators and lens assemblies are mounted on metal front plates and enclosures. When mounted in insulated enclosures, the "total insulation" protective measures are met.		
Shock resistance according to IEC 60068-2-27 for half-sine shock type, 11 ms shock duration	<ul style="list-style-type: none"> Devices without incandescent lamp Devices with incandescent lamp 		
		≤ 50 g ≤ 30 g	
Vibration resistance acc. to IEC 60068-2-6	<ul style="list-style-type: none"> Acceleration at frequency 20 ... 200 Hz 		
		5 g	





Type	3SB38 0.-0, 3SB38 0.-1	—	3SB38 0.-2, 3SB38 0.-3
Enclosures			
Enclosure material	Plastic		Metal
Actuators and indicators	Plastic, round		Metal, round
Degree of protection acc. to IEC 60529	IP65		IP67 and NEMA Type 4
Resistance to extreme climates acc. to DIN 50017	KTW 24		KTW 24

Push Button Units and Indicator Lights

3SB3, Metal, Round, 22 mm

Complete Units

Selection and ordering data

Rated voltage of lamp	Color of handle	Contacts for front plate mounting	DT	Screw terminals	DT	Spring-type terminals
						
						
				Order No.		Order No.

V

Push buttons

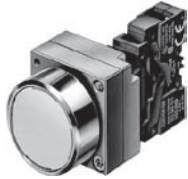

Push button with flat button

Push buttons with flat button

Black	1 NO	3SB36 02-0AA11	3SB36 02-0AA11-0CC0
Black	1 NC	3SB36 03-0AA11	3SB36 03-0AA11-0CC0
Red	1 NC	3SB36 03-0AA21	3SB36 03-0AA21-0CC0
Yellow	1 NO	3SB36 02-0AA31	3SB36 02-0AA31-0CC0
Green	1 NO	3SB36 02-0AA41	3SB36 02-0AA41-0CC0
Blue	1 NO	3SB36 02-0AA51	3SB36 02-0AA51-0CC0
White	1 NO	3SB36 02-0AA61	3SB36 02-0AA61-0CC0
Black	1 NO + 1 NC	3SB36 01-0AA11	3SB36 01-0AA11-0CC0
Red	1 NO + 1 NC	3SB36 01-0AA21	3SB36 01-0AA21-0CC0
Yellow	1 NO + 1 NC	3SB36 01-0AA31	3SB36 01-0AA31-0CC0
Green	1 NO + 1 NC	3SB36 01-0AA41	3SB36 01-0AA41-0CC0
Blue	1 NO + 1 NC	3SB36 01-0AA51	3SB36 01-0AA51-0CC0
White	1 NO + 1 NC	3SB36 01-0AA61	3SB36 01-0AA61-0CC0
Clear	1 NO + 1 NC	3SB36 01-0AA71	—

Push button unit with extended button

Black	1 NO	3SB36 02-0BA11	—
Black	1 NC	3SB36 03-0BA11	—
Red	1 NC	3SB36 03-0BA21	—
Yellow	1 NO	3SB36 02-0BA31	—
Blue	1 NO	3SB36 02-0BA51	—
White	1 NO	3SB36 02-0BA61	—
Black	1 NO + 1 NC	3SB36 01-0BA11	—
Red	1 NO + 1 NC	3SB36 01-0BA21	—
Yellow	1 NO + 1 NC	3SB36 01-0BA31	—
Green	1 NO + 1 NC	3SB36 01-0BA41	—
Blue	1 NO + 1 NC	3SB36 01-0BA51	—
White	1 NO + 1 NC	3SB36 01-0BA61	—

Illuminated push buttons with flat button

momentary with integrated LED
(incl. holder for 3 elements)

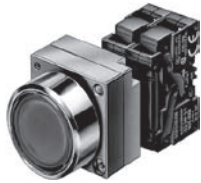

Illuminated push button with flat button

24 AC/DC	Red ¹⁾	1 NC	3SB36 46-0AA21	3SB36 46-0AA21-0CC0
	Yellow ¹⁾	1 NO	3SB36 45-0AA31	3SB36 45-0AA31-0CC0
	Green ¹⁾	1 NO	3SB36 45-0AA41	3SB36 45-0AA41-0CC0
	Blue ¹⁾	1 NO	3SB36 45-0AA51	3SB36 45-0AA51-0CC0
	White	1 NO	3SB36 45-0AA61	3SB36 45-0AA61-0CC0
	Clear ¹⁾	1 NO	3SB36 45-0AA71	3SB36 45-0AA71-0CC0
	Red ¹⁾	1 NO + 1 NC	3SB36 47-0AA21	3SB36 47-0AA21-0CC0
	Yellow ¹⁾	1 NO + 1 NC	3SB36 47-0AA31	3SB36 47-0AA31-0CC0
	Green ¹⁾	1 NO + 1 NC	3SB36 47-0AA41	3SB36 47-0AA41-0CC0
	Blue ¹⁾	1 NO + 1 NC	3SB36 47-0AA51	3SB36 47-0AA51-0CC0
	White	1 NO + 1 NC	3SB36 47-0AA61	3SB36 47-0AA61-0CC0
	Clear ¹⁾	1 NO + 1 NC	3SB36 47-0AA71	3SB36 47-0AA71-0CC0
110 AC	Red ¹⁾	1 NC	3SB36 50-0AA21	—
	Yellow ¹⁾	1 NO	3SB36 57-0AA31	—
	Green ¹⁾	1 NO	3SB36 57-0AA41	—
	Blue ¹⁾	1 NO	3SB36 57-0AA51	—
	White	1 NO	3SB36 57-0AA61	—
	Clear ¹⁾	1 NO	3SB36 57-0AA71	—
	Red ¹⁾	1 NO + 1 NC	3SB36 51-0AA21	—
	Yellow ¹⁾	1 NO + 1 NC	3SB36 51-0AA31	—
	Green ¹⁾	1 NO + 1 NC	3SB36 51-0AA41	—
	Blue ¹⁾	1 NO + 1 NC	3SB36 51-0AA51	—
	White	1 NO + 1 NC	3SB36 51-0AA61	—
	Clear ¹⁾	1 NO + 1 NC	3SB36 51-0AA71	—
230 AC	Red ¹⁾	1 NC	3SB36 54-0AA21	3SB36 54-0AA21-0CC0
	Yellow ¹⁾	1 NO	3SB36 53-0AA31	3SB36 53-0AA31-0CC0
	Green ¹⁾	1 NO	3SB36 53-0AA41	3SB36 53-0AA41-0CC0
	Blue ¹⁾	1 NO	3SB36 53-0AA51	3SB36 53-0AA51-0CC0
	White	1 NO	3SB36 53-0AA61	3SB36 53-0AA61-0CC0
	Clear ¹⁾	1 NO	3SB36 53-0AA71	3SB36 53-0AA71-0CC0
	Red ¹⁾	1 NO + 1 NC	3SB36 55-0AA21	3SB36 55-0AA21-0CC0
	Yellow ¹⁾	1 NO + 1 NC	3SB36 55-0AA31	3SB36 55-0AA31-0CC0
	Green ¹⁾	1 NO + 1 NC	3SB36 55-0AA41	3SB36 55-0AA41-0CC0
	Blue ¹⁾	1 NO + 1 NC	3SB36 55-0AA51	3SB36 55-0AA51-0CC0
	White	1 NO + 1 NC	3SB36 55-0AA61	3SB36 55-0AA61-0CC0
	Clear ¹⁾	1 NO + 1 NC	3SB36 55-0AA71	3SB36 55-0AA71-0CC0

 For online configurator see www.siemens.com/sirius/configurators.

¹⁾ Inscription is possible by inserting a label.

Push Button Units and Indicator Lights

3SB3, Metal, Round, 22 mm

Complete Units

Rated voltage of lamp	Color of handle	Contacts for front plate mounting	DT	Screw terminals	DT	Spring-type terminals
				Order No.		Order No.

Push buttons

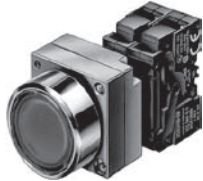

Illuminated push button with flat button

Illuminated push buttons with flat button
with BA 9s lamp holder, without lamp
(incl. holder for 3 elements)

—	Red ¹⁾	1 NC	3SB36 07-0AA21	3SB36 07-0AA21-0CC0
	Amber ¹⁾	1 NO	3SB36 06-0AA01	—
	Yellow ¹⁾	1 NO	3SB36 06-0AA31	3SB36 06-0AA31-0CC0
	Green ¹⁾	1 NO	3SB36 06-0AA41	3SB36 06-0AA41-0CC0
	Blue ¹⁾	1 NO	3SB36 06-0AA51	3SB36 06-0AA51-0CC0
	White	1 NO	3SB36 06-0AA61	3SB36 06-0AA61-0CC0
	Clear ¹⁾	1 NO	3SB36 06-0AA71	3SB36 06-0AA71-0CC0
	Red ¹⁾	1 NO + 1 NC	3SB36 05-0AA21	3SB36 05-0AA21-0CC0
	Amber ¹⁾	1 NO + 1 NC	3SB36 05-0AA01	—
	Yellow ¹⁾	1 NO + 1 NC	3SB36 05-0AA31	3SB36 05-0AA31-0CC0
	Green ¹⁾	1 NO + 1 NC	3SB36 05-0AA41	3SB36 05-0AA41-0CC0
	Blue ¹⁾	1 NO + 1 NC	3SB36 05-0AA51	3SB36 05-0AA51-0CC0
	White	1 NO + 1 NC	3SB36 05-0AA61	3SB36 05-0AA61-0CC0
	Clear ¹⁾	1 NO + 1 NC	3SB36 05-0AA71	3SB36 05-0AA71-0CC0

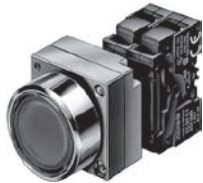

Illuminated push button with flat button

Illuminated push buttons with flat, solvent-resistant button²⁾,
with integrated LED (incl. holder for 3 elements)

24 AC/DC	Red ¹⁾	1 NC	3SB36 46-0AA21-0PA0	—
	Yellow ¹⁾	1 NO	3SB36 45-0AA31-0PA0	—
	Green ¹⁾	1 NO	3SB36 45-0AA41-0PA0	—
	Blue ¹⁾	1 NO	3SB36 45-0AA51-0PA0	—
	White	1 NO	3SB36 45-0AA61-0PA0	—
	Clear ¹⁾	1 NO	3SB36 45-0AA71-0PA0	—
	Red ¹⁾	1 NO + 1 NC	3SB36 47-0AA21-0PA0	—
	Yellow ¹⁾	1 NO + 1 NC	3SB36 47-0AA31-0PA0	—
	Green ¹⁾	1 NO + 1 NC	3SB36 47-0AA41-0PA0	—
	Blue ¹⁾	1 NO + 1 NC	3SB36 47-0AA51-0PA0	—
	White	1 NO + 1 NC	3SB36 47-0AA61-0PA0	—
	Clear ¹⁾	1 NO + 1 NC	3SB36 47-0AA71-0PA0	—

Mushroom push buttons

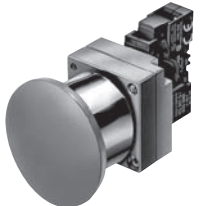

Mushroom push-pull button

Mushroom push-pull buttons, Ø 40 mm, maintained
with pull-to-unlatch mechanism

—	Red	1 NC	3SB36 03-1CA21	3SB36 03-1CA21-0CC0
		1 NO + 1 NC	3SB36 01-1CA21	3SB36 01-1CA21-0CC0

For online configurator see www.siemens.com/sirius/configurators.





¹⁾ Inscription is possible by inserting a label.

²⁾ Not suitable for laser inscription.

Push Button Units and Indicator Lights

3SB3, Metal, Round, 22 mm

Complete Units

Version	Color of handle/ Lock No.	Contacts for front plate mounting	DT	Screw terminals 	DT	Spring-type terminals 
				Configurator 		Configurator 
				Order No.		Order No.

Selector switches

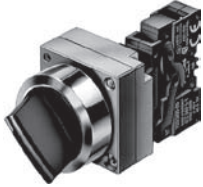

Selector switch

Selector switches, 2 switch positions

Switching sequence O-I, 50° operating angle

Latching



Black,	1 NO	3SB36 02-2KA11	3SB36 02-2KA11-0CC0
Standard	1 NO + 1 NC	3SB36 01-2KA11	3SB36 01-2KA11-0CC0
Black,	1 NO	3SB36 02-2PA11	—
Heavy duty	1 NO + 1 NC	3SB36 01-2PA11	—

Selector switches, 3 switch positions

switching sequence I-O-II, 2 x 50° operating angle

Latching



Black,	1 NO, 1 NO	3SB36 10-2DA11	3SB36 10-2DA11-0CC0
Standard	1 NO + 1 NC, 1 NO + 1 NC	3SB36 08-2DA11	3SB36 08-2DA11-0CC0
Black,	1 NO, 1 NO	3SB36 10-2SA11	—
Heavy duty	1 NO + 1 NC, 1 NO + 1 NC	3SB36 08-2SA11	—

Momentary, spring
return from the left
and right



Black,	1 NO, 1 NO	3SB36 10-2EA11	3SB36 10-2EA11-0CC0
Standard	1 NO + 1 NC, 1 NO + 1 NC	3SB36 08-2EA11	3SB36 08-2EA11-0CC0
Black,	1 NO, 1 NO	3SB36 10-2TA11	—
Heavy duty	1 NO + 1 NC, 1 NO + 1 NC	3SB36 08-2TA11	—

Key-operated switches

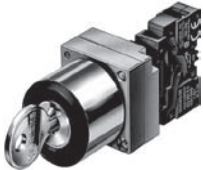

RONIS key-operated
switch

RONIS key-operated switch, 2 switch positions

with 2 keys, removal position O + I,
switching sequence O-I, 50° operating angle

Latching







SB 30	1 NO	3SB36 02-4AD11	3SB36 02-4AD11-0CC0
	1 NO + 1 NC	3SB36 01-4AD11	3SB36 01-4AD11-0CC0

 For online configurator see www.siemens.com/sirius/configurators .

Push Button Units and Indicator Lights

3SB3, Metal, Round, 22 mm

Complete Units

Color of handle	Contacts for front plate mounting	DT	Screw terminals 	DT	Spring-type terminals 
			Configurator 		Configurator 
			Order No.		Order No.

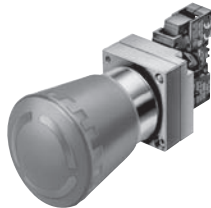

EMERGENCY-STOP devices according to ISO 13850, with yellow name plate, Ø 80 mm, with inscription



EMERGENCY-STOP mushroom push button with rotate-to-unlatch mechanism

EMERGENCY-STOP mushroom push buttons, Ø 40 mm, with positive maintained function, with rotate-to-unlatch mechanism

- English inscription "EMERGENCY STOP"



Red	1 NC		3SB36 03-1HR20	—
	1 NC with mounting monitoring		3SB36 66-1HR20	—
	1 NO + 1 NC		3SB36 01-1HR20	—



EMERGENCY-STOP mushroom push button with rotate-to-unlatch mechanism and switch position indication

With rotate-to-unlatch mechanism and mechanical switch position indication

- English inscription "EMERGENCY STOP"

Red	1 NC		3SB36 03-1HR26	—
	1 NC with mounting monitoring		3SB36 66-1HR26	—
	1 NO + 1 NC		3SB36 01-1HR26	—

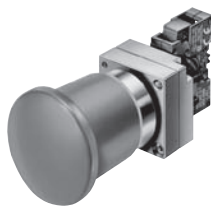

EMERGENCY-STOP mushroom push button Pull-to-unlatch mechanism

With pull-to-unlatch mechanism, solvent-resistant

- English inscription "EMERGENCY STOP"

Red	1 NC		3SB36 03-1TR20	—
	1 NO + 1 NC		3SB36 01-1TR20	—

 For online configurator see www.siemens.com/sirius/configurators .





 Positive opening according to IEC 60947-5-1, Appendix K. Can be used with 3TK28 safety relays. Certificate:



Push Button Units and Indicator Lights

3SB3, Metal, Round, 22 mm

Complete Units

Rated voltage of lamp	Color of lens	DT	Screw terminals 	DT	Spring-type terminals 
			Configurator 		Configurator 
V			Order No.		Order No.

Indicator lights



Indicator light

Indicator lights with lens with concentric rings ¹⁾ with integrated LED			
24 AC/DC	Red Yellow Green Blue White Clear Amber	3SB36 44-6BA20 3SB36 44-6BA30 3SB36 44-6BA40 3SB36 44-6BA50 3SB36 44-6BA60 3SB36 44-6BA70 3SB36 44-6BA00	3SB36 44-6BA20-0CC0 3SB36 44-6BA30-0CC0 3SB36 44-6BA40-0CC0 3SB36 44-6BA50-0CC0 3SB36 44-6BA60-0CC0 3SB36 44-6BA70-0CC0 —
110 AC	Red Yellow Green Blue White Clear Amber	3SB36 48-6BA20 3SB36 48-6BA30 3SB36 48-6BA40 3SB36 48-6BA50 3SB36 48-6BA60 3SB36 48-6BA70 3SB36 48-6BA00	3SB36 48-6BA20-0CC0 3SB36 48-6BA30-0CC0 3SB36 48-6BA40-0CC0 3SB36 48-6BA50-0CC0 3SB36 48-6BA60-0CC0 3SB36 48-6BA70-0CC0 —
230 AC	Red Yellow Green Blue White Clear	3SB36 52-6BA20 3SB36 52-6BA30 3SB36 52-6BA40 3SB36 52-6BA50 3SB36 52-6BA60 3SB36 52-6BA70	3SB36 52-6BA20-0CC0 3SB36 52-6BA30-0CC0 3SB36 52-6BA40-0CC0 3SB36 52-6BA50-0CC0 3SB36 52-6BA60-0CC0 3SB36 52-6BA70-0CC0
With BA 9s lamp holder, without lamp	—		
	Red Yellow Green Blue White Clear	3SB36 04-6BA20 3SB36 04-6BA30 3SB36 04-6BA40 3SB36 04-6BA50 3SB36 04-6BA60 3SB36 04-6BA70	3SB36 04-6BA20-0CC0 3SB36 04-6BA30-0CC0 3SB36 04-6BA40-0CC0 3SB36 04-6BA50-0CC0 3SB36 04-6BA60-0CC0 3SB36 04-6BA70-0CC0

 For online configurator see www.siemens.com/sirius/configurators.









¹⁾ Inscription by inserting a label is not possible.

Push Button Units and Indicator Lights

3SB3, Metal, Round, 22 mm

Actuators and Indicators

Selection and ordering data

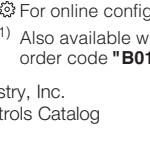
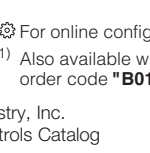
Version	Inscriptions	Color of handle	DT	Configurator	PS		
				Order No.			
Push buttons with holder¹⁾							
	Push buttons with flat button	Black		3SB35 00-0AA11	1 unit		
		Red		3SB35 00-0AA21	1 unit		
		Yellow		3SB35 00-0AA31	1 unit		
		Green		3SB35 00-0AA41	1 unit		
		Blue		3SB35 00-0AA51	1 unit		
		White		3SB35 00-0AA61	1 unit		
		Gray		3SB35 00-0AB51	1 unit		
		Clear ²⁾		3SB35 00-0AA71	1 unit		
		Up	Black		3SB35-00-0AA11-ZED	1 unit	
		Down	Black		3SB35-00-0AA11-ZEE	1 unit	
	Push buttons with raised button	Forward	Black	3SB35-00-0AA11-ZEF	1 unit		
		Reverse	Black	3SB35-00-0AA11-ZEG	1 unit		
		On	Green	3SB35 00-0AA41-ZEB	1 unit		
		Start	Green	3SB35 00-0AA41-ZEL	1 unit		
		I	Green	3SB35 00-0AA81	1 unit		
		O	Red	3SB35 00-0AB01	1 unit		
		I	White	3SB35 00-0AB11	1 unit		
		O	Black	3SB35 00-0AB21	1 unit		
		R	Blue	3SB35 00-0AC81	1 unit		
			Push buttons with flat solvent-resistant button³⁾	Black		3SB35 00-0AA11	1 unit
Red				3SB35 00-0AA21-0PA0	1 unit		
Yellow				3SB35 00-0AA31-0PA0	1 unit		
Green				3SB35 00-0AA41-0PA0	1 unit		
Blue				3SB35 00-0AA51-0PA0	1 unit		
White				3SB35 00-0AA61-0PA0	1 unit		
	Push buttons with raised button	Black		3SB35 00-0BA11	1 unit		
		Red		3SB35 00-0BA21	1 unit		
		Yellow		3SB35 00-0BA31	1 unit		
		Green		3SB35 00-0BA41	1 unit		
		Blue		3SB35 00-0BA51	1 unit		
		White		3SB35 00-0BA61	1 unit		
		Off	Red	3SB35-00-0BA21-ZEC			
		Stop	Red	3SB35-00-0BA21-ZEK			
			Push buttons with raised front ring (height 15.5 mm)	Black		3SB35 00-0AA12	1 unit
				Red		3SB35 00-0AA22	1 unit
Yellow				3SB35 00-0AA32	1 unit		
Green				3SB35 00-0AA42	1 unit		
Blue				3SB35 00-0AA52	1 unit		
White				3SB35 00-0AA62	1 unit		
	Illuminated push buttons with flat button (incl. holder for 3 elements)	Amber ²⁾		3SB35 01-0AA01	1 unit		
		Red ²⁾		3SB35 01-0AA21	1 unit		
		Yellow ²⁾		3SB35 01-0AA31	1 unit		
		Green ²⁾		3SB35 01-0AA41	1 unit		
		Blue ²⁾		3SB35 01-0AA51	1 unit		
		White		3SB35 01-0AA61	1 unit		
		Clear ²⁾		3SB35 01-0AA71	1 unit		
	Illuminated push buttons with flat, solvent-resistant button³⁾ (incl. holder for 3 elements)	Red ²⁾		3SB35 01-0AA21-0PA0	1 unit		
		Yellow ²⁾		3SB35 01-0AA31-0PA0	1 unit		
		Green ²⁾		3SB35 01-0AA41-0PA0	1 unit		
		Blue ²⁾		3SB35 01-0AA51-0PA0	1 unit		
		White		3SB35 01-0AA61-0PA0	1 unit		
		Clear ²⁾		3SB35 01-0AA71-0PA0	1 unit		
			Illuminated push buttons with raised button (incl. holder for 3 elements)	Amber		3SB35 01-0BA01	1 unit
Red				3SB35 01-0BA21	1 unit		
Yellow				3SB35 01-0BA31	1 unit		
Green				3SB35 01-0BA41	1 unit		
Blue				3SB35 01-0BA51	1 unit		
White				3SB35 01-0BA61	1 unit		
Clear				3SB35 01-0BA71	1 unit		
	Push buttons with flat button, maintained, unlatches by pressing again	Black		3SB35 00-0DA11	1 unit		
		Red		3SB35 00-0DA21	1 unit		
		Yellow		3SB35 00-0DA31	1 unit		
		Green		3SB35 00-0DA41	1 unit		
		Blue		3SB35 00-0DA51	1 unit		
		White		3SB35 00-0DA61	1 unit		
		Gray		3SB35 00-0DB51	1 unit		
	Illuminated push buttons with flat button, maintained, unlatches by pressing again (incl. holder for 3 elements)	Amber ²⁾		3SB35 01-0DA01	1 unit		
		Red ²⁾		3SB35 01-0DA21	1 unit		
		Yellow ²⁾		3SB35 01-0DA31	1 unit		
		Green ²⁾		3SB35 01-0DA41	1 unit		
		Blue ²⁾		3SB35 01-0DA51	1 unit		
		White		3SB35 01-0DA61	1 unit		
		Clear ²⁾		3SB35 01-0DA71	1 unit		

¹⁾ For online configurator see www.siemens.com/sirius/configurators.

²⁾ Also available without holder. Supplement Order No. with "-Z" and quote order code "B01". Price reduction on request.





³⁾ Inscription is possible by inserting a label.

⁴⁾ Not suitable for laser inscription.

Push Button Units and Indicator Lights

3SB3, Metal, Round, 22 mm

Actuators and Indicators

Version	Color of handle	DT	Configurator 	PS	
			Order No.		
Mushroom push buttons with holder¹⁾					
	Mushroom push buttons, Ø 30 mm		Black Red Yellow Green	3SB35 00-1DA11 3SB35 00-1DA21 3SB35 00-1DA31 3SB35 00-1DA41	1 unit 1 unit 1 unit 1 unit
	Mushroom push buttons, Ø 40 mm		Black Red Yellow Green	3SB35 00-1GA11 3SB35 00-1GA21 3SB35 00-1GA31 3SB35 00-1GA41	1 unit 1 unit 1 unit 1 unit
	Mushroom push buttons, Ø 60 mm		Black Red Yellow Green	3SB35 00-1QA11 3SB35 00-1QA21 3SB35 00-1QA31 3SB35 00-1QA41	1 unit 1 unit 1 unit 1 unit
	Illuminated mushroom push buttons, Ø 30 mm (incl. holder for 3 elements)		Amber Yellow Green White	3SB35 01-1DA01 3SB35 01-1DA31 3SB35 01-1DA41 3SB35 01-1DA61	1 unit 1 unit 1 unit 1 unit
	Illuminated mushroom push buttons, Ø 40 mm (incl. holder for 3 elements)		Amber Yellow Green White Clear	3SB35 01-1GA01 3SB35 01-1GA31 3SB35 01-1GA41 3SB35 01-1GA61 3SB35 01-1GA71	1 unit 1 unit 1 unit 1 unit 1 unit
	Illuminated mushroom push buttons, Ø 60 mm (incl. holder for 3 elements)		Amber Yellow Green White	3SB35 01-1QA01 3SB35 01-1QA31 3SB35 01-1QA41 3SB35 01-1QA61	1 unit 1 unit 1 unit 1 unit
	Push-pull buttons, Ø 30 mm, maintained, pull to unlatch		Black Red	3SB35 00-1EA11 3SB35 00-1EA21	1 unit 1 unit
		Push-pull buttons, Ø 40 mm, maintained, pull to unlatch		Black Red Yellow Green	3SB35 00-1CA11 3SB35 00-1CA21 3SB35 00-1CA31 3SB35 00-1CA41
Push-pull buttons, Ø 60 mm, maintained, pull to unlatch		Black Red	3SB35 00-1RA11 3SB35 00-1RA21	1 unit 1 unit	
Push-pull buttons, Ø 30 mm, maintained, pull to unlatch, can be illuminated (incl. holder for 3 elements)		Amber Red Yellow Green Blue Clear	3SB35 01-1EA01 3SB35 01-1EA21 3SB35 01-1EA31 3SB35 01-1EA41 3SB35 01-1EA51 3SB35 01-1EA71	1 unit 1 unit 1 unit 1 unit 1 unit 1 unit	
		Push-pull buttons, Ø 40 mm, maintained, pull to unlatch, can be illuminated (incl. holder for 3 elements)		Amber Red Yellow Green Blue Clear	3SB35 01-1CA01 3SB35 01-1CA21 3SB35 01-1CA31 3SB35 01-1CA41 3SB35 01-1CA51 3SB35 01-1CA71
	Push-pull buttons, Ø 60 mm, maintained, pull to unlatch, can be illuminated (incl. holder for 3 elements)		Amber Red Yellow Green Blue Clear	3SB35 01-1RA01 3SB35 01-1RA21 3SB35 01-1RA31 3SB35 01-1RA41 3SB35 01-1RA51 3SB35 01-1RA71	1 unit 1 unit 1 unit 1 unit 1 unit 1 unit

Mushroom push button, Ø 30 mm

Mushroom push button, Ø 40 mm

Illuminated mushroom push button, Ø 60 mm

Push-pull button, Ø 30 mm

Push-pull button, Ø 40 mm

Push-pull button, Ø 60 mm, can be illuminated

 For online configurator see www.siemens.com/sirius/configurators.

¹⁾ Also available without holder. Supplement Order No. with "-Z" and quote order code "B01". Price reduction on request.

Push Button Units and Indicator Lights

3SB3, Metal, Round, 22 mm

Actuators and Indicators

1
2
3
4
5
6
7
8
9
10

Version	Version Illumination	Color of handle	DT	Configurator 	PS
				Order No.	

Selector switches with holders



Selector switch, 2 switch positions, standard version, 90°

Selector switches with 2 switch positions

Switching sequence O-I, 90° operating angle, maintained



Non-illuminated, standard version¹⁾

Black
Red
Green
White

3SB35 00-2HA11
3SB35 00-2HA21
3SB35 00-2HA41
3SB35 00-2HA61

1 unit
1 unit
1 unit
1 unit

Non-illuminated, with solvent-resistant short handle¹⁾

Black
Red
Green

3SB35 00-2HA11-0PA0
3SB35 00-2HA21-0PA0
3SB35 00-2HA41-0PA0

1 unit
1 unit
1 unit

Illuminated, standard version¹⁾
(incl. holder for 3 elements)

Amber
Red
Yellow
Green
Blue
Clear

3SB35 01-2HA01
3SB35 01-2HA21
3SB35 01-2HA31
3SB35 01-2HA41
3SB35 01-2HA51
3SB35 01-2HA71

1 unit
1 unit
1 unit
1 unit
1 unit
1 unit



Selector switch, 2 switch positions, standard version, 50°

Switching sequence O-I, 50° operating angle, maintained



Non-illuminated, standard version¹⁾

Black
Red
Green
White

3SB35 00-2KA11
3SB35 00-2KA21
3SB35 00-2KA41
3SB35 00-2KA61

1 unit
1 unit
1 unit
1 unit

Non-illuminated, with solvent-resistant short handle¹⁾

Black
Red
Green

3SB35 00-2KA11-0PA0
3SB35 00-2KA21-0PA0
3SB35 00-2KA41-0PA0

1 unit
1 unit
1 unit

Illuminated, standard version¹⁾
(incl. holder for 3 elements)

Amber
Red
Yellow
Green
Blue
Clear

3SB35 01-2KA01
3SB35 01-2KA21
3SB35 01-2KA31
3SB35 01-2KA41
3SB35 01-2KA51
3SB35 01-2KA71

1 unit
1 unit
1 unit
1 unit
1 unit
1 unit



Selector switch, 2 switch positions, heavy-duty version

Illuminated, with solvent-resistant short handle¹⁾ (incl. holder for 3 elements)

Red
Green
Blue
Clear

3SB35 01-2KA21-0PA0
3SB35 01-2KA41-0PA0
3SB35 01-2KA51-0PA0
3SB35 01-2KA71-0PA0

1 unit
1 unit
1 unit
1 unit

Non-illuminated, heavy-duty version

Black
Red
Green
White

3SB35 00-2PA11
3SB35 00-2PA21
3SB35 00-2PA41
3SB35 00-2PA61

1 unit
1 unit
1 unit
1 unit

Illuminated, heavy-duty version
(incl. holder for 3 elements)

Amber
Red
Yellow
Green
Blue
Clear

3SB35 01-2PA01
3SB35 01-2PA21
3SB35 01-2PA31
3SB35 01-2PA41
3SB35 01-2PA51
3SB35 01-2PA71

1 unit
1 unit
1 unit
1 unit
1 unit
1 unit



Selector switch, 2 switch positions, long handle

Non-illuminated, long handle, heavy duty version

Black
Red
Green
White

3SB35 00-3PA11
3SB35 00-3PA21
3SB35 00-3PA41
3SB35 00-3PA61

1 unit
1 unit
1 unit
1 unit

Illuminated long handle, heavy duty version
(incl. holder for 3 elements)

Red
Yellow
Green
Blue
Amber
Clear

3SB35 01-3PA21
3SB35 01-3PA31
3SB35 01-3PA41
3SB35 01-3PA51
3SB35 01-3PA01
3SB35 01-3PA71

1 unit
1 unit
1 unit
1 unit
1 unit
1 unit

 For online configurator see www.siemensv.com/sirius/configurators

¹⁾ Also available without holder. Supplement Order No. with "-Z" and quote order code "B01". Price reduction on request.

Push Button Units and Indicator Lights

3SB3, Metal, Round, 22 mm

Actuators and Indicators

Version	Version Illumination	Color of handle	DT	Configurator 	PS
				Order No.	

Selector switches with holders



Selector switch, 2 switch positions, standard version



Selector switch, 2 switch positions, heavy-duty version



Selector switch, 2 switch positions, long handle

Selector switches with 2 switch positions

Switching sequence O-I, 50° operating angle, momentary, spring return from the right



Non-illuminated, standard version ¹⁾	Black	3SB35 00-2LA11	1 unit
	Red	3SB35 00-2LA21	1 unit
	Green	3SB35 00-2LA41	1 unit
	White	3SB35 00-2LA61	1 unit
Non-illuminated, with solvent-resistant short handle ¹⁾	Black	3SB35 00-2LA11-0PA0	1 unit
	Red	3SB35 00-2LA21-0PA0	1 unit
	Green	3SB35 00-2LA41-0PA0	1 unit
Illuminated, standard version ¹⁾ (incl. holder for 3 elements)	Amber	3SB35 01-2LA01	1 unit
	Red	3SB35 01-2LA21	1 unit
	Yellow	3SB35 01-2LA31	1 unit
	Green	3SB35 01-2LA41	1 unit
	Blue	3SB35 01-2LA51	1 unit
	Clear	3SB35 01-2LA71	1 unit
Illuminated, with solvent-resistant short handle ¹⁾ (incl. holder for 3 elements)	Red	3SB35 01-2LA21-0PA0	1 unit
	Green	3SB35 01-2LA41-0PA0	1 unit
	Blue	3SB35 01-2LA51-0PA0	1 unit
	Clear	3SB35 01-2LA71-0PA0	1 unit
Non-illuminated, heavy-duty version	Black	3SB35 00-2QA11	1 unit
	Red	3SB35 00-2QA21	1 unit
	Green	3SB35 00-2QA41	1 unit
	White	3SB35 00-2QA61	1 unit
Illuminated, heavy-duty version (incl. holder for 3 elements)	Amber	3SB35 01-2QA01	1 unit
	Red	3SB35 01-2QA21	1 unit
	Yellow	3SB35 01-2QA31	1 unit
	Green	3SB35 01-2QA41	1 unit
	Blue	3SB35 01-2QA51	1 unit
	Clear	3SB35 01-2QA71	1 unit
Non-illuminated, long handle, heavy-duty version	Black	3SB35 00-3QA11	1 unit
	Red	3SB35 00-3QA21	1 unit
	Green	3SB35 00-3QA41	1 unit
	White	3SB35 00-3QA61	1 unit
Illuminated long handle, heavy-duty version (incl. holder for 3 elements)	Amber	3SB35 01-3QA01	1 unit
	Red	3SB35 01-3QA21	1 unit
	Yellow	3SB35 01-3QA31	1 unit
	Green	3SB35 01-3QA41	1 unit
	Blue	3SB35 01-3QA51	1 unit
Clear	3SB35 01-3QA71	1 unit	

 For online configurator see www.siemens.com/sirius/configurators.

¹⁾ Also available without holder. Supplement Order No. with "-Z" and quote order code "B01". Price reduction on request.

Push Button Units and Indicator Lights

3SB3, Metal, Round, 22 mm

Actuators and Indicators

Version	Version Illumination	Color of handle	DT	Configurator 	PS
				Order No.	

Selector switches with holders



Selector switch, 3 switch positions, standard version



Selector switch, 3 switch positions, heavy-duty version



Selector switch, 3 switch positions, long handle

Selector switches with 3 switch positions

Switching sequence I-O-II, 2 x 50° operating angle, maintained



Non-illuminated, standard version¹⁾

Black
Red
Green
White

3SB35 00-2DA11
3SB35 00-2DA21
3SB35 00-2DA41
3SB35 00-2DA61

1 unit
1 unit
1 unit
1 unit

Non-illuminated, with solvent-resistant short handle¹⁾

Black
Red
Green

3SB35 00-2DA11-0PA0
3SB35 00-2DA21-0PA0
3SB35 00-2DA41-0PA0

1 unit
1 unit
1 unit

Illuminated, standard version¹⁾ (incl. holder for 3 elements)

Amber
Red
Yellow
Green
Blue
Clear

3SB35 01-2DA01
3SB35 01-2DA21
3SB35 01-2DA31
3SB35 01-2DA41
3SB35 01-2DA51
3SB35 01-2DA71

1 unit
1 unit
1 unit
1 unit
1 unit
1 unit

Illuminated, with solvent-resistant short handle¹⁾ (incl. holder for 3 elements)

Red
Green
Blue
Clear

3SB35 01-2DA21-0PA0
3SB35 01-2DA41-0PA0
3SB35 01-2DA51-0PA0
3SB35 01-2DA71-0PA0

1 unit
1 unit
1 unit
1 unit

Non-illuminated, heavy-duty version

Black
Red
Green
White

3SB35 00-2SA11
3SB35 00-2SA21
3SB35 00-2SA41
3SB35 00-2SA61

1 unit
1 unit
1 unit
1 unit

Illuminated, heavy-duty version (incl. holder for 3 elements)

Amber
Red
Yellow
Green
Blue
Clear

3SB35 01-2SA01
3SB35 01-2SA21
3SB35 01-2SA31
3SB35 01-2SA41
3SB35 01-2SA51
3SB35 01-2SA71

1 unit
1 unit
1 unit
1 unit
1 unit
1 unit

Non-illuminated, long handle, heavy-duty version

Black
Red
Green
White

3SB35 00-3SA11
3SB35 00-3SA21
3SB35 00-3SA41
3SB35 00-3SA61

1 unit
1 unit
1 unit
1 unit

Illuminated long handle, heavy-duty version (incl. holder for 3 elements)

Amber
Red
Yellow
Green
Blue
Clear

3SB35 01-3SA01
3SB35 01-3SA21
3SB35 01-3SA31
3SB35 01-3SA41
3SB35 01-3SA51
3SB35 01-3SA71

1 unit
1 unit
1 unit
1 unit
1 unit
1 unit

Switching sequence I-O-II, 2 x 50° operating angle, momentary, spring return from the left and right



Non-illuminated, standard version¹⁾

Black
Red
Green
White

3SB35 00-2EA11
3SB35 00-2EA21
3SB35 00-2EA41
3SB35 00-2EA61

1 unit
1 unit
1 unit
1 unit

Non-illuminated, with solvent-resistant short handle¹⁾

Black
Red
Green

3SB35 00-2EA11-0PA0
3SB35 00-2EA21-0PA0
3SB35 00-2EA41-0PA0

1 unit
1 unit
1 unit

Illuminated, standard version¹⁾ (incl. holder for 3 elements)

Amber
Red
Yellow
Green
Blue
Clear

3SB35 01-2EA01
3SB35 01-2EA21
3SB35 01-2EA31
3SB35 01-2EA41
3SB35 01-2EA51
3SB35 01-2EA71

1 unit
1 unit
1 unit
1 unit
1 unit
1 unit

Illuminated, with solvent-resistant short handle¹⁾ (incl. holder for 3 elements)

Red
Green
Blue
Clear

3SB35 01-2EA21-0PA0
3SB35 01-2EA41-0PA0
3SB35 01-2EA51-0PA0
3SB35 01-2EA71-0PA0

1 unit
1 unit
1 unit
1 unit

Non-illuminated, heavy-duty version

Black
Red
Green
White

3SB35 00-2TA11
3SB35 00-2TA21
3SB35 00-2TA41
3SB35 00-2TA61

1 unit
1 unit
1 unit
1 unit

Illuminated, heavy-duty version (incl. holder for 3 elements)

Amber
Red
Yellow
Green
Blue
Clear

3SB35 01-2TA01
3SB35 01-2TA21
3SB35 01-2TA31
3SB35 01-2TA41
3SB35 01-2TA51
3SB35 01-2TA71

1 unit
1 unit
1 unit
1 unit
1 unit
1 unit

Non-illuminated, long handle, heavy-duty version

Black
Red
Green
White

3SB35 00-3TA11
3SB35 00-3TA21
3SB35 00-3TA41
3SB35 00-3TA61

1 unit
1 unit
1 unit
1 unit

Illuminated long handle, heavy-duty version (incl. holder for 3 elements)

Amber
Red
Yellow
Green
Blue
Clear







3SB35 01-3TA01
3SB35 01-3TA21
3SB35 01-3TA31
3SB35 01-3TA41
3SB35 01-3TA51
3SB35 01-3TA71

1 unit
1 unit
1 unit
1 unit
1 unit
1 unit

Push Button Units and Indicator Lights

3SB3, Metal, Round, 22 mm

Actuators and Indicators

Version	Version Illumination	Color of handle	DT	Configurator 	PS
				Order No.	
Selector switches with holders					
Selector switches with 3 switch positions (cont)					
 <p>Selector switch, 3 switch positions, standard version</p>	<p>Switching sequence I-O-II, 2 x 50° operating angle, momentary to the left, spring return from the left, maintained to the right</p> 	Non-illuminated, standard version ¹⁾	Black	3SB35 00-2GA11	1 unit
			Red	3SB35 00-2GA21	1 unit
			Green	3SB35 00-2GA41	1 unit
			White	3SB35 00-2GA61	1 unit
		illuminated, standard version ¹⁾ (incl. holder for 3 elements)	Amber	3SB35 01-2GA01	1 unit
			Red	3SB35 01-2GA21	1 unit
			Yellow	3SB35 01-2GA31	1 unit
			Green	3SB35 01-2GA41	1 unit
		Non-illuminated, heavy-duty version	Black	3SB35 00-2VA11	1 unit
			Red	3SB35 00-2VA21	1 unit
			Green	3SB35 00-2VA41	1 unit
			White	3SB35 00-2VA61	1 unit
illuminated, heavy-duty version	Amber	3SB35 01-2VA01	1 unit		
	Red	3SB35 01-2VA21	1 unit		
	Yellow	3SB35 01-2VA31	1 unit		
	Green	3SB35 01-2VA41	1 unit		
Non-illuminated, heavy-duty version	Black	3SB35 00-3VA11	1 unit		
	Red	3SB35 00-3VA21	1 unit		
	Green	3SB35 00-3VA41	1 unit		
	White	3SB35 00-3VA61	1 unit		
illuminated, long handle, heavy-duty version	Amber	3SB35 01-3UA01	1 unit		
	Red	3SB35 01-3UA21	1 unit		
	Yellow	3SB35 01-3UA31	1 unit		
	Green	3SB35 01-3UA41	1 unit		
 <p>Selector switch, 3 switch positions, heavy-duty version</p>	<p>Switching sequence I-O-II, 2 x 50° operating angle, momentary to the left, spring return from the right</p> 	Non-illuminated, standard version ¹⁾	Black	3SB35 00-2FA11	1 unit
			Red	3SB35 00-2FA21	1 unit
			Green	3SB35 00-2FA41	1 unit
			White	3SB35 00-2FA61	1 unit
		illuminated, standard version ¹⁾ (incl. holder for 3 elements)	Amber	3SB35 01-2FA01	1 unit
			Red	3SB35 01-2FA21	1 unit
			Yellow	3SB35 01-2FA31	1 unit
			Green	3SB35 01-2FA41	1 unit
		Non-illuminated, heavy-duty version	Black	3SB35 00-2UA11	1 unit
			Red	3SB35 00-2UA21	1 unit
			Green	3SB35 00-2UA41	1 unit
			White	3SB35 00-2UA61	1 unit
illuminated, heavy-duty version	Amber	3SB35 01-2UA01	1 unit		
	Red	3SB35 01-2UA21	1 unit		
	Yellow	3SB35 01-2UA31	1 unit		
	Green	3SB35 01-2UA41	1 unit		
Non-illuminated, long handle	Black	3SB35 00-3UA11	1 unit		
	Red	3SB35 00-3UA21	1 unit		
	Green	3SB35 00-3UA41	1 unit		
	White	3SB35 00-3UA61	1 unit		
illuminated, long handle, heavy-duty version (incl. holder for 3 elements)	Amber	3SB35 01-3UA01	1 unit		
	Red	3SB35 01-3UA21	1 unit		
	Yellow	3SB35 01-3UA31	1 unit		
	Green	3SB35 01-3UA41	1 unit		
 <p>Selector switch, 3 switch positions, long handle</p>	Blue	3SB35 01-3UA51	1 unit		
	Clear	3SB35 01-3UA71	1 unit		
	Blue	3SB35 01-3UA51	1 unit		
	Clear	3SB35 01-3UA71	1 unit		

 For online configurator see www.siemens.com/sirius/configurators.

¹⁾ Also available without holder. Supplement Order No. with "-Z" and quote order code "B01". Price reduction on request.

Push Button Units and Indicator Lights

3SB3, Metal, Round, 22 mm

Actuators and Indicators

Version	Lock version		DT	Configurator 	PS
	Type	Lock No./color			
				Order No.	

Key-operated switches with holder¹⁾

Key-operated switches with 2 keys, 2 switch positions



RONIS key-operated switch

Switching sequence O-I,
50° operating angle,
maintained



CES key-operated switch



BKS key-operated switch



O.M.R. key-operated switch

Switching sequence O-I,
50° operating angle,
momentary, spring return
from the right



Lock version	Lock No./color	Key removal position	Configurator	PS
RONIS	SB 30	O+I	3SB35 00-4AD11	1 unit
		O	3SB35 00-4AD01	1 unit
		I	3SB35 00-4AD21	1 unit
CES	SSG 10	O+I	3SB35 00-4LD11	1 unit
		O	3SB35 00-4LD01	1 unit
		I	3SB35 00-4LD21	1 unit
	LSG 1	O+I	3SB35 00-4LF01	1 unit
		O	3SB35 00-4LF11	1 unit
BKS	S1	O+I	3SB35 00-5AD11	1 unit
		O	3SB35 00-5AD01	1 unit
		I	3SB35 00-5AD21	1 unit
O.M.R. ²⁾	73038 Light blue	O+I	3SB35 00-3AG11	1 unit
		O	3SB35 00-3AG01	1 unit
		I	3SB35 00-3AG21	1 unit
	73037 Red	O+I	3SB35 00-3AH11	1 unit
		O	3SB35 00-3AH01	1 unit
		I	3SB35 00-3AH21	1 unit
	73034 Black	O+I	3SB35 00-3AJ11	1 unit
		O	3SB35 00-3AJ01	1 unit
		I	3SB35 00-3AJ21	1 unit
	73033 Yellow	O+I	3SB35 00-3AK11	1 unit
		O	3SB35 00-3AK01	1 unit
		I	3SB35 00-3AK21	1 unit
RONIS	SB 30	O	3SB35 00-4BD01	1 unit
CES	SSG 10	O	3SB35 00-4MD01	1 unit
	LSG 1	O	3SB35 00-4MF11	1 unit
BKS	S1	O	3SB35 00-5BD01	1 unit
O.M.R. ²⁾	73038 Light blue	O	3SB35 00-3BG01	1 unit
	73037 Red	O	3SB35 00-3BH01	1 unit
	73034 Black	O	3SB35 00-3BJ01	1 unit
	73033 Yellow	O	3SB35 00-3BK01	1 unit

 For online configurator see www.siemens.com/sirius/configurators.

¹⁾ Also available without holder. Supplement Order No. with "-Z" and quote order code "B01". Price reduction on request.

²⁾ According to FIAT standards; also available for other users.

For BKS and CES special locks see page 10/69

Push Button Units and Indicator Lights

3SB3, Metal, Round, 22 mm

Actuators and Indicators

Version	Lock version			DT	Configurator 	PS
	Type	Lock No./color	Key removal position			
					Order No.	

Key-operated switches with holder¹⁾

Key-operated switches with 2 keys, 3 switch positions



RONIS key-operated switch

Switching sequence I-O-II,
2 x 50° operating angle,
maintained



CES key-operated switch



BKS key-operated switch



O.M.R. key-operated switch

Switching sequence I-O-II,
2 x 50° operating angle,
momentary, spring return from
the left and right



Switching sequence I-O-II,
2 x 50° operating angle,
momentary to the left,
spring return from the left,
maintained to the right



Switching sequence I-O-II,
2 x 50° operating angle,
maintained to the left,
momentary to the right,
spring return from the right



RONIS	SB 30	I+O+II O I+II I II O+I	3SB35 00-4DD11 3SB35 00-4DD01 3SB35 00-4DD41 3SB35 00-4DD21 3SB35 00-4DD31 3SB35 00-4DD51	1 unit 1 unit 1 unit 1 unit 1 unit 1 unit
CES	SSG 10	O+I+II O I+II I II	3SB35 00-4PD11 3SB35 00-4PD01 3SB35 00-4PD41 3SB35 00-4PD21 3SB35 00-4PD31	1 unit 1 unit 1 unit 1 unit 1 unit
BKS	S1	O O+I+II I II I+II	3SB35 00-5DD01 3SB35 00-5DD11 3SB35 00-5DD21 3SB35 00-5DD31 3SB35 00-5DD41	1 unit 1 unit
O.M.R. ²⁾	73038 Light blue	I+O+II	3SB35 00-3DG11	1 unit
	73037 Red	I+O+II O	3SB35 00-3DH11 3SB35 00-3DG01	1 unit 1 unit
	73034 Black	I+O+II O	3SB35 00-3DJ11 3SB35 00-3DJ01	1 unit 1 unit
RONIS	SB 30	O	3SB35 00-4ED01	1 unit
CES	SSG 10	O	3SB35 00-4QD01	1 unit
BKS	S1	O	3SB35 00-5ED01	1 unit
O.M.R.	73034 Black	O	3SB35 00-3EJ01	1 unit
RONIS	SB 30	O + II O II	3SB35 00-4GD61 3SB35 00-4GD01 3SB35 00-4GD31	1 unit 1 unit 1 unit
CES	SSG 10	O + II O II	3SB35 00-4SD61 3SB35 00-4SD01 3SB35 00-4SD31	1 unit 1 unit 1 unit
BKS	S1	O + II O II	3SB35 00-5GD61 3SB35 00-5GD01 3SB35 00-5GD31	1 unit 1 unit 1 unit
O.M.R.	73033 Yellow	II	3SB35 00-3GK31	1 unit
	73034 Black	II	3SB35 00-3GJ31	1 unit
RONIS	SB 30	O+I O I	3SB35 00-4FD51 3SB35 00-4FD01 3SB35 00-4FD21	1 unit 1 unit 1 unit
CES	SSG 10	O+I O I	3SB35 00-4RD51 3SB35 00-4RD01 3SB35 00-4RD21	1 unit 1 unit 1 unit
BKS	S1	O+I O I	3SB35 00-5FD51 3SB35 00-5FD01 3SB35 00-5FD21	1 unit 1 unit 1 unit

 For online configurator see www.siemens.com/sirius/configurators.

¹⁾ Also available without holder. Supplement Order No. with "-Z" and quote order code "B01". Price reduction on request.

²⁾ According to FIAT standards; also available for other users.

For BKS and CES special locks see page 10/69

Push Button Units and Indicator Lights

3SB3, Metal, Round, 22 mm

Actuators and Indicators

1
2
3
4
5
6
7
8
9
10

Version	Color of handle	Approval	DT	Configurator 	PS
				Order No.	

EMERGENCY-STOP devices according to ISO 13850 and IEC 60947-5-5, with holder¹⁾²⁾. Can also be used with 3TK28 safety relays.



Mushroom diameter 32 mm

EMERGENCY-STOP mushroom push buttons, Ø 32 mm, with positive latching according to ISO 13850, with rotate-to-unlatch mechanism

- Standard version
- Solvent-resistant



3SB35 00-1FA20
3SB35 00-1FA20-0PA0

1 unit
1 unit



Mushroom diameter 40 mm, with rotate-to-unlatch mechanism, with switch position indication

EMERGENCY-STOP mushroom push buttons, Ø 40 mm, with positive latching according to ISO 13850, with rotate-to-unlatch mechanism

- Without switch position indicator
- Without switch position indicator, solvent-resistant
- With mechanical switch position indication

Red



3SB35 00-1HA20
3SB35 00-1HA20-0PA0

1 unit
1 unit



Mushroom diameter 40 mm, pull-to-unlatch mechanism

EMERGENCY-STOP mushroom push buttons, Ø 40 mm, with positive latching according to ISO 13850, with pull-to-unlatch mechanism

Red



3SB35 00-1TA20

1 unit



Mushroom diameter 60 mm

EMERGENCY-STOP mushroom push buttons, Ø 60 mm, with positive latching according to ISO 13850, with rotate-to-unlatch mechanism

Red



3SB35 00-1AA20

1 unit

Mushroom diameter 60 mm

EMERGENCY-STOP mushroom push buttons, Ø 40 mm with positive latching function with IKON lock
Lock No. 360012K1, supplied with 2 keys, unlocking only possible using key

Red



3SB35 00-1UA20

1 unit



Mushroom diameter 40 mm, with RONIS key-operated switch

EMERGENCY-STOP mushroom push buttons, Ø 40 mm, with RONIS key-operated switch
(with 2 keys), lock No. SB 30, with positive latching according to ISO 13850, unlocking only possible using key

Red



3SB35 00-1BA20

1 unit



Mushroom diameter 40 mm, with CES key-operated switch

EMERGENCY-STOP mushroom push buttons, Ø 40 mm, with CES key-operated switch,
(with 2 keys), lock No. SSG 10, with positive latching according to ISO 13850, unlocking only possible using key

Red



3SB35 00-1KA20

1 unit

EMERGENCY-STOP mushroom push buttons, Ø 40 mm, with BKS key-operated switch,
(with 2 keys), lock No. S1, with positive latching according to ISO 13850, unlocking only possible using key

Red



3SB35 00-1LA20

1 unit

EMERGENCY-STOP mushroom push buttons, Ø 40 mm, with O.M.R. key-operated switch
(with 2 keys), lock No. 73037, with positive latching according to ISO 13850, unlocking only using key

Red



3SB35 00-1MA20

1 unit

Wobble Stick

3SB35 00-7CB61

 For online configurator see www.siemens.com/sirius/configurators

1) Also available without holder. Supplement Order No. with “-Z” and quote order code “B01”. Price reduction on request.



2) Yellow backing plates must be ordered separately; see “Accessories” on page 10/84.

For BKS and CES special locks see page 10/69

Push Button Units and Indicator Lights

3SB3, Metal, Round, 22 mm

Actuators and Indicators

Version	Color of lens	DT	Configurator 	PS
			Order No.	
Signaling elements with holder¹⁾				
 Indicator light with smooth lens	Indicator lights with lens with concentric rings²⁾	Amber	3SB35 01-6BA00	1 unit
		Red	3SB35 01-6BA20	1 unit
		Yellow	3SB35 01-6BA30	1 unit
		Green	3SB35 01-6BA40	1 unit
		Blue	3SB35 01-6BA50	1 unit
		White	3SB35 01-6BA60	1 unit
		Clear	3SB35 01-6BA70	1 unit
	Indicator lights with smooth lens²⁾	Amber	3SB35 01-6AA00	1 unit
		Red	3SB35 01-6AA20	1 unit
		Yellow	3SB35 01-6AA30	1 unit
		Green	3SB35 01-6AA40	1 unit
		Blue	3SB35 01-6AA50	1 unit
		White	3SB35 01-6AA60	1 unit
		Clear	3SB35 01-6AA70	1 unit
	Indicator lights with smooth solvent-resistant lens²⁾³⁾	Red	3SB35 01-6AA20-0PA0	1 unit
		Yellow	3SB35 01-6AA30-0PA0	1 unit
		Green	3SB35 01-6AA40-0PA0	1 unit
		Blue	3SB35 01-6AA50-0PA0	1 unit
		White	3SB35 01-6AA60-0PA0	1 unit
	Clear	3SB35 01-6AA70-0PA0	1 unit	

 For online configurator see www.siemens.com/sirius/configurators.

¹⁾ Also available without holder. Supplement Order No. with "-Z" and quote order code "B01". Price reduction on request.

²⁾ Inscription by inserting a label is not possible.

³⁾ Not suitable for laser inscription.

Push Button Units and Indicator Lights

3SB3, Plastic, Round, 22 mm

Complete units

1
2
3
4
5
6
7
8
9
10

Selection and ordering data

Rated voltage of lamp	Color of handle	Contacts for front plate mounting	DT	Screw terminals	DT	Spring-type terminals
				Order No.		Order No.

Push buttons

Push buttons with flat button



Push button with flat button

Color of handle	Contacts for front plate mounting	DT	Screw terminals	DT	Spring-type terminals
Black	1 NO		3SB32 02-0AA11		3SB32 02-0AA11-0CC0
Black	1 NC		3SB32 03-0AA11		3SB32 03-0AA11-0CC0
Red	1 NC		3SB32 03-0AA21		3SB32 03-0AA21-0CC0
Yellow	1 NO		3SB32 02-0AA31		3SB32 02-0AA31-0CC0
Green	1 NO		3SB32 02-0AA41		3SB32 02-0AA41-0CC0
Blue	1 NO		3SB32 02-0AA51		3SB32 02-0AA51-0CC0
White	1 NO		3SB32 02-0AA61		3SB32 02-0AA61-0CC0
Black	1 NO + 1 NC		3SB32 01-0AA11		3SB32 01-0AA11-0CC0
Red	1 NO + 1 NC		3SB32 01-0AA21		3SB32 01-0AA21-0CC0
Yellow	1 NO + 1 NC		3SB32 01-0AA31		3SB32 01-0AA31-0CC0
Green	1 NO + 1 NC		3SB32 01-0AA41		3SB32 01-0AA41-0CC0
Blue	1 NO + 1 NC		3SB32 01-0AA51		3SB32 01-0AA51-0CC0
White	1 NO + 1 NC		3SB32 01-0AA61		3SB32 01-0AA61-0CC0

Push Button with extended button momentary

Color of handle	Contacts for front plate mounting	DT	Screw terminals	DT	Spring-type terminals
Black	1 NO		3SB3202-0BA11		—
Black	1 NC		3SB3203-0BA11		—
Red	1 NC		3SB3203-0BA21		—
Yellow	1 NO		3SB3202-0BA31		—
Blue	1 NO		3SB3202-0BA51		—
White	1 NO		3SB3202-0BA61		—
Black	1 NO + 1 NC		3SB3201-0BA11		—
Red	1 NO + 1 NC		3SB3201-0BA21		—
Yellow	1 NO + 1 NC		3SB3201-0BA31		—
Blue	1 NO + 1 NC		3SB3201-0BA51		—
White	1 NO + 1 NC		3SB3201-0BA61		—

Illuminated push buttons with flat button with integrated LED (incl. holder for 3 elements)



Illuminated push button with flat button

Rated voltage of lamp	Color of handle	Contacts for front plate mounting	DT	Screw terminals	DT	Spring-type terminals
24 AC/DC	Red ¹⁾	1 NC		3SB32 46-0AA21		3SB32 46-0AA21-0CC0
	Yellow ¹⁾	1 NO		3SB32 45-0AA31		3SB32 45-0AA31-0CC0
	Green ¹⁾	1 NO		3SB32 45-0AA41		3SB32 45-0AA41-0CC0
	Blue ¹⁾	1 NO		3SB32 45-0AA51		3SB32 45-0AA51-0CC0
	White	1 NO		3SB32 45-0AA61		3SB32 45-0AA61-0CC0
	Clear ¹⁾	1 NO		3SB32 45-0AA71		3SB32 45-0AA71-0CC0
24 AC/DC	Red ¹⁾	1 NO + 1 NC		3SB32 47-0AA21		3SB32 47-0AA21-0CC0
	Yellow ¹⁾	1 NO + 1 NC		3SB32 47-0AA31		3SB32 47-0AA31-0CC0
	Green ¹⁾	1 NO + 1 NC		3SB32 47-0AA41		3SB32 47-0AA41-0CC0
	Blue ¹⁾	1 NO + 1 NC		3SB32 47-0AA51		3SB32 47-0AA51-0CC0
	White	1 NO + 1 NC		3SB32 47-0AA61		3SB32 47-0AA61-0CC0
	Clear ¹⁾	1 NO + 1 NC		3SB32 47-0AA71		3SB32 47-0AA71-0CC0
110 AC	Red ¹⁾	1 NC		3SB32 50-0AA21		—
	Yellow ¹⁾	1 NO		3SB32 57-0AA31		—
	Green ¹⁾	1 NO		3SB32 57-0AA41		—
	Blue ¹⁾	1 NO		3SB32 57-0AA51		—
	White	1 NO		3SB32 57-0AA61		—
	Clear ¹⁾	1 NO		3SB32 57-0AA71		—
110 AC	Red ¹⁾	1 NO + 1 NC		3SB32 51-0AA21		—
	Yellow ¹⁾	1 NO + 1 NC		3SB32 51-0AA31		—
	Green ¹⁾	1 NO + 1 NC		3SB32 51-0AA41		—
	Blue ¹⁾	1 NO + 1 NC		3SB32 51-0AA51		—
	White	1 NO + 1 NC		3SB32 51-0AA61		—
	Clear ¹⁾	1 NO + 1 NC		3SB32 51-0AA71		—
230 AC	Red ¹⁾	1 NC		3SB32 54-0AA21		3SB32 54-0AA21-0CC0
	Yellow ¹⁾	1 NO		3SB32 53-0AA31		3SB32 53-0AA31-0CC0
	Green ¹⁾	1 NO		3SB32 53-0AA41		3SB32 53-0AA41-0CC0
	Blue ¹⁾	1 NO		3SB32 53-0AA51		3SB32 53-0AA51-0CC0
	White	1 NO		3SB32 53-0AA61		3SB32 53-0AA61-0CC0
	Clear ¹⁾	1 NO		3SB32 53-0AA71		3SB32 53-0AA71-0CC0
230 AC	Red ¹⁾	1 NO + 1 NC		3SB32 55-0AA21		3SB32 55-0AA21-0CC0
	Yellow ¹⁾	1 NO + 1 NC		3SB32 55-0AA31		3SB32 55-0AA31-0CC0
	Green ¹⁾	1 NO + 1 NC		3SB32 55-0AA41		3SB32 55-0AA41-0CC0
	Blue ¹⁾	1 NO + 1 NC		3SB32 55-0AA51		3SB32 55-0AA51-0CC0
	White	1 NO + 1 NC		3SB32 55-0AA61		3SB32 55-0AA61-0CC0
	Clear ¹⁾	1 NO + 1 NC		3SB32 55-0AA71		3SB32 55-0AA71-0CC0

For online configurator see www.siemens.com/sirius/configurators.

¹⁾ Inscription is possible by inserting a label.

Push Button Units and Indicator Lights

3SB3, Plastic, Round, 22 mm

Complete units

Color of handle	Contacts for front plate mounting	DT	Screw terminals	DT	Spring-type terminals
			Configurator		Configurator
			Order No.		Order No.

Push buttons



Illuminated push button with flat button

Illuminated push buttons with flat button

with BA 9s lamp holder, without lamp
(incl. holder for 3 elements)

Red ¹⁾	1 NC
Yellow ¹⁾	1 NO
Green ¹⁾	1 NO
Blue ¹⁾	1 NO
White	1 NO
Clear ¹⁾	1 NO

3SB32 07-0AA21
3SB32 06-0AA31
3SB32 06-0AA41
3SB32 06-0AA51
3SB32 06-0AA61
3SB32 06-0AA71

3SB32 07-0AA21-0CC0
3SB32 06-0AA31-0CC0
3SB32 06-0AA41-0CC0
3SB32 06-0AA51-0CC0
3SB32 06-0AA61-0CC0
3SB32 06-0AA71-0CC0

Red ¹⁾	1 NO + 1 NC
Yellow ¹⁾	1 NO + 1 NC
Green ¹⁾	1 NO + 1 NC
Blue ¹⁾	1 NO + 1 NC
White	1 NO + 1 NC
Clear ¹⁾	1 NO + 1 NC

3SB32 05-0AA21
3SB32 05-0AA31
3SB32 05-0AA41
3SB32 05-0AA51
3SB32 05-0AA61
3SB32 05-0AA71

3SB32 05-0AA21-0CC0
3SB32 05-0AA31-0CC0
3SB32 05-0AA41-0CC0
3SB32 05-0AA51-0CC0
3SB32 05-0AA61-0CC0
3SB32 05-0AA71-0CC0

Illuminated push buttons with flat button

with BA 9s lamp holder with incandescent lamp
24 V AC/DC

Red	1 NC
Red	1 NO + 1 NC
Yellow	1 NO + 1 NC
Green	1 NO + 1 NC
Blue	1 NO + 1 NC
White	1 NO + 1 NC
Clear	1 NO + 1 NC

3SB3213-0AA21
3SB3221-0AA21
3SB3221-0AA31
3SB3221-0AA41
3SB3221-0AA51
3SB3221-0AA61
3SB3221-0AA71

—
—
—
—
—
—
—

Illuminated push buttons with flat button

with BA 9s lamp holder with incandescent lamp
230 V AC/DC

Red	1 NC
Yellow	1 NO
Green	1 NO
Blue	1 NO
White	1 NO
Clear	1 NO

3SB3216-0AA21
3SB3214-0AA31
3SB3214-0AA41
3SB3214-0AA51
3SB3214-0AA61
3SB3214-0AA71

—
—
—
—
—
—

Red	1 NO + 1 NC
Yellow	1 NO + 1 NC
Green	1 NO + 1 NC
Blue	1 NO + 1 NC
White	1 NO + 1 NC
Clear	1 NO + 1 NC

3SB3213-0AA21
3SB3213-0AA31
3SB3213-0AA41
3SB3213-0AA51
3SB3213-0AA61
3SB3213-0AA71

—
—
—
—
—
—

Mushroom push buttons



Mushroom push-pull button

Mushroom push-pull buttons, Ø 40 mm, maintained,

with pull-to-unlatch mechanism

Red	1 NC
	1 NO + 1 NC

3SB32 03-1CA21
3SB32 01-1CA21

3SB32 03-1CA21-0CC0
3SB32 01-1CA21-0CC0





For online configurator see www.siemens.com/sirius/configurators.

¹⁾ Inscription is possible by inserting a label.

Push Button Units and Indicator Lights

3SB3, Plastic, Round, 22 mm

Complete units

Version	Color of handle/ Lock No.	Contacts for front plate mounting	DT	Screw terminals 	DT	Spring-type terminals 
				Configurator 		Configurator 
				Order No.		Order No.

Selector switches



Selector switch

Selector switches, 2 switch positions

Switching sequence O-I, 50° operating angle

Latching	Black	1 NO	3SB32 02-2KA11	3SB32 02-2KA11-0CC0
		1 NO + 1 NC	3SB32 01-2KA11	3SB32 01-2KA11-0CC0



Selector switches, 2 switch positions

Switching sequence O-I, 90° operating angle

Latching	Black	1 NO	3SB32 02-2HA11	—
		1 NO + 1 NC	3SB32 01-2HA11	—



Selector switches, 3 switch positions

switching sequence I-O-II, 2 x 50° operating angle

Latching	Black	1 NO, 1 NO	3SB32 10-2DA11	3SB32 10-2DA11-0CC0
		1 NO + 1 NC,	3SB32 08-2DA11	3SB32 08-2DA11-0CC0
		1 NO + 1 NC		



Momentary, spring return from left and right	Black	1 NO, 1 NO	3SB32 10-2EA11	3SB32 10-2EA11-0CC0
		1 NO + 1 NC,	3SB32 08-2EA11	3SB32 08-2EA11-0CC0
		1 NO + 1 NC		



Key-operated switches

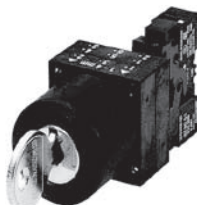

RONIS key-operated switch

RONIS key-operated switches, 2 switch positions

with 2 keys, removal position O + I, switching sequence O-I, 50° operating angle

Latching	SB 30	1 NO	3SB32 02-4AD11	3SB32 02-4AD11-0CC0
		1 NO + 1 NC	3SB32 01-4AD11	3SB32 01-4AD11-0CC0



Switching sequence I-O-II, maintained, operating angle 2 x 50°

Latching	SB 30	1 NO, 1 NO	3SB32 10-4DD11	—
		1 NO + 1 NC,	3SB32 08-4DD11	—
		1 NO + 1 NC		



Twin push buttons



Twin push button with flat buttons

Twin push buttons, with flat, square buttons¹⁾

With I/O inscription	White/White	1 NO + 1 NC,	3SB31 00-8AC61	—
		1 NO + 1 NC		





 For online configurator see www.siemens.com/sirius/configurators.

¹⁾ Mounting the twin push buttons in 3SB38 enclosure is not possible. For accessories see page 10/55.

Push Button Units and Indicator Lights

3SB3, Plastic, Round, 22 mm

Complete units

Color of handle	Contacts for front plate mounting	DT	Screw terminals 	DT	Spring-type terminals 
			Configurator 		Configurator 
			Order No.		Order No.



EMERGENCY-STOP devices according to ISO 13850, with yellow name plate, Ø 80 mm, with inscription



With rotate-to-unlatch mechanism

EMERGENCY-STOP mushroom push buttons, Ø 40 mm, with positive maintained function, with rotate-to-unlatch mechanism

- English inscription "EMERGENCY STOP"

Red	1 NC	
	1 NC with mounting monitoring	
Red	1 NO + 1 NC	



3SB32 03-1HR20	—
3SB32 66-1HR20	—
3SB32 01-1HR20	—



With rotate-to-unlatch mechanism and switch position indication

With rotate-to-unlatch mechanism and mechanical switch position indication

- English inscription "EMERGENCY STOP"

Red	1 NC	
	1 NC with mounting monitoring	
Red	1 NO + 1 NC	

3SB32 03-1HR26	—
3SB32 66-1HR26	—
3SB32 01-1HR26	—



With pull-to-unlatch mechanism

With pull-to-unlatch mechanism

- English inscription "EMERGENCY STOP"

Red	1 NC	
Red	1 NO + 1 NC	

3SB32 03-1TR20	—
3SB32 01-1TR20	—

 For online configurator see www.siemens.com/sirius/configurators.

 Positive opening according to IEC 60947-5-1, Appendix K. Can be used with 3TK28 safety relays.





Certificate:



Push Button Units and Indicator Lights

3SB3, Plastic, Round, 22 mm

Complete units

Rated voltage of lamp	Color of lens	DT	Screw terminals 	DT	Spring-type terminals 
V			Configurator 		Configurator 
			Order No.		Order No.

Indicator lights



Indicator light with smooth lens

Indicator lights with smooth lens ¹⁾ with integrated LED			
24 AC/DC	Red Yellow Green Blue White Clear	3SB32 44-6AA20 3SB32 44-6AA30 3SB32 44-6AA40 3SB32 44-6AA50 3SB32 44-6AA60 3SB32 44-6AA70	3SB32 44-6AA20-0CC0 3SB32 44-6AA30-0CC0 3SB32 44-6AA40-0CC0 3SB32 44-6AA50-0CC0 3SB32 44-6AA60-0CC0 3SB32 44-6AA70-0CC0
110 AC	Red Yellow Green Blue White Clear	3SB32 48-6AA20 3SB32 48-6AA30 3SB32 48-6AA40 3SB32 48-6AA50 3SB32 48-6AA60 3SB32 48-6AA70	— — — — — —
230 AC	Red Yellow Green Blue White Clear	3SB32 52-6AA20 3SB32 52-6AA30 3SB32 52-6AA40 3SB32 52-6AA50 3SB32 52-6AA60 3SB32 52-6AA70	3SB32 52-6AA20-0CC0 3SB32 52-6AA30-0CC0 3SB32 52-6AA40-0CC0 3SB32 52-6AA50-0CC0 3SB32 52-6AA60-0CC0 3SB32 52-6AA70-0CC0
With BA 9s lamp holder, without lamp	Red Yellow Green Blue White Clear	3SB32 04-6AA20 3SB32 04-6AA30 3SB32 04-6AA40 3SB32 04-6AA50 3SB32 04-6AA60 3SB32 04-6AA70	3SB32 04-6AA20-0CC0 3SB32 04-6AA30-0CC0 3SB32 04-6AA40-0CC0 3SB32 04-6AA50-0CC0 3SB32 04-6AA60-0CC0 3SB32 04-6AA70-0CC0
With BA 9s lamp holder with lamp (130 V) 24 V AC/DC	Red Yellow Green Blue White Clear	3SB32 17-6AA20 3SB32 17-6AA30 3SB32 17-6AA40 3SB32 17-6AA50 3SB32 17-6AA60 3SB32 17-6AA70	— — — — — —
With BA 9s lamp holder with lamp (130 V) 230 V AC/DC	Red Yellow Green Blue White Clear	3SB32 12-6AA20 3SB32 12-6AA30 3SB32 12-6AA40 3SB32 12-6AA50 3SB32 12-6AA60 3SB32 12-6AA70	3SB32 12-6AA20-0CC0 3SB32 12-6AA30-0CC0 3SB32 12-6AA40-0CC0 3SB32 12-6AA50-0CC0 3SB32 12-6AA60-0CC0 3SB32 12-6AA70-0CC0





 For online configurator see www.siemens.com/sirius/configurators.

¹⁾ Inscription by inserting a label is not possible.

Push Button Units and Indicator Lights

3SB3, Plastic, Round, 22 mm

Complete units

Rated voltage of lamp	Color of lens	DT	Screw terminals 	DT	Spring-type terminals 
			Configurator 		Configurator 
V			Order No.		Order No.

Indicator lights



Indicator light with lens with concentric rings

Indicator lights with lens with concentric rings ¹⁾ with integrated LED			
24 AC/DC	Red Yellow Green Blue White Clear	3SB32 44-6BA20 3SB32 44-6BA30 3SB32 44-6BA40 3SB32 44-6BA50 3SB32 44-6BA60 3SB32 44-6BA70	3SB32 44-6BA20-0CC0 3SB32 44-6BA30-0CC0 3SB32 44-6BA40-0CC0 3SB32 44-6BA50-0CC0 3SB32 44-6BA60-0CC0 3SB32 44-6BA70-0CC0
110 AC	Red Yellow Green Blue White Clear	3SB32 48-6BA20 3SB32 48-6BA30 3SB32 48-6BA40 3SB32 48-6BA50 3SB32 48-6BA60 3SB32 48-6BA70	— — — — — —
230 AC	Red Yellow Green Blue White Clear	3SB32 52-6BA20 3SB32 52-6BA30 3SB32 52-6BA40 3SB32 52-6BA50 3SB32 52-6BA60 3SB32 52-6BA70	3SB32 52-6BA20-0CC0 3SB32 52-6BA30-0CC0 3SB32 52-6BA40-0CC0 3SB32 52-6BA50-0CC0 3SB32 52-6BA60-0CC0 3SB32 52-6BA70-0CC0
With BA 9s lamp holder, without lamp			
	Amber Red Yellow Green Blue White Clear	3SB32 04-6BA00 3SB32 04-6BA20 3SB32 04-6BA30 3SB32 04-6BA40 3SB32 04-6BA50 3SB32 04-6BA60 3SB32 04-6BA70	— 3SB32 04-6BA20-0CC0 3SB32 04-6BA30-0CC0 3SB32 04-6BA40-0CC0 3SB32 04-6BA50-0CC0 3SB32 04-6BA60-0CC0 3SB32 04-6BA70-0CC0
With BA 9s lamp holder, with LED			
130 AC	Amber Red Yellow Green Blue White Clear	3SB32 40-6BA00 3SB32 40-6BA20 3SB32 40-6BA30 3SB32 40-6BA40 3SB32 40-6BA50 3SB32 40-6BA60 3SB32 40-6BA70	— — — — — — —
With BA 9s lamp holder with incandescent lamp (130 V)			
24 V AC/DC	Red Yellow Green Blue White Clear	3SB32 36-6BA20 3SB32 36-6BA30 3SB32 36-6BA40 3SB32 36-6BA50 3SB32 36-6BA60 3SB32 36-6BA70	— — — — — —
With integrated LED			
230 AC	Red Yellow Green Blue White Clear	3SB32 52-6BA20 3SB32 52-6BA30 3SB32 52-6BA40 3SB32 52-6BA50 3SB32 52-6BA60 3SB32 52-6BA70	3SB32 52-6BA20-0CC0 3SB32 52-6BA30-0CC0 3SB32 52-6BA40-0CC0 3SB32 52-6BA50-0CC0 3SB32 52-6BA60-0CC0 3SB32 52-6BA70-0CC0

 For online configurator see www.siemens.com/sirius/configurators

¹⁾ Inscription by inserting a label is not possible.

Push Button Units and Indicator Lights

3SB3, Plastic, Round, 22 mm

Complete units

Version	Rated voltage of lamp	Color of lens	DT	Screw terminals	PS
				Configurator	
				Order No.	

Signaling devices



Acoustic signaling device

Acoustic signaling devices, IP65¹⁾

Continuous tone 2.4 kHz, operational current min. 4 mA, sound pressure min. 80 dB/10 cm	Rated voltage of lamp	Color of lens
	24 AC/DC	Black
	115 AC/DC	
	230 AC/DC	

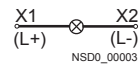

3SB32 33-7BA10	1 unit
3SB32 34-7BA10	1 unit
3SB32 35-7BA10	1 unit

For online configurator see www.siemens.com/sirius/configurators.

¹⁾ Mounting in 3SB38 enclosures only with the 3SB3400-1A lamp holder for front plate mounting, which is included.

Version	Degree of protection	Color of handle	DT	Without connection	PS
				Order No.	

Special devices



Potentiometer drive

Actuators for potentiometers²⁾³⁾

With shaft Ø 6 mm, 30 ... 32 mm long	Degree of protection	Color of handle
	IP65	—

3SB10 00-7CH07	1 unit
-----------------------	--------



Push buttons with 12 mm stroke

Push buttons with extended stroke²⁾ for actuating relays

12 mm stroke	Degree of protection	Color of handle
	IP65	Black

3SB30 00-0EA11	1 unit
-----------------------	--------

Mechanical Reset¹⁾

Overload reset adapter	S00 to S10/S12	Color of handle
Reset Push Button IP65 Ø 22mm, 12 mm stroke	S10/S12	—
Reset extension	S10/S12	
Complete assembly		

3RU19 00-1A	1 unit
3SX1335	1 unit
3SBES-RESET	1 unit

²⁾ Mounting in 3SB38 enclosure is not possible.











³⁾ The potentiometer is not included in the scope of supply.

Push Button Units and Indicator Lights

3SB3, Plastic, Round, 22 mm

Actuators and Indicators

Selection and ordering data

Version	Inscriptions	Color of handle	DT	Configurator 	PS		
				Order No.			
Push buttons with holder¹⁾							
	Push buttons with flat button	Black		3SB30 00-0AA11	1 unit		
		Red		3SB30 00-0AA21	1 unit		
		Yellow		3SB30 00-0AA31	1 unit		
		Green		3SB30 00-0AA41	1 unit		
		Blue		3SB30 00-0AA51	1 unit		
		White		3SB30 00-0AA61	1 unit		
		Gray		3SB30 00-0AB51	1 unit		
		Clear ²⁾		3SB30 00-0AA71	1 unit		
		I	Green		3SB30 00-0AA81	1 unit	
		O	Red		3SB30 00-0AB01	1 unit	
		I	White		3SB30 00-0AB11	1 unit	
		O	Black		3SB30 00-0AB21	1 unit	
		R	Blue		3SB30 00-0AC81	1 unit	
		Down	Black		3SB30 00-0AA11-ZEE	1 unit	
Up	Black		3SB30 00-0AA11-ZED				
Forward	Black		3SB30 00-0AA11-ZEF				
Reverse	Black		3SB30 00-0AA11-ZEG				
On	Green		3SB30 00-0AA11-ZEB				
Start	Red		3SB30 00-0AA11-ZEL				
Reset	Blue		3SB30 00-0AA11-ZEM				
	Push buttons with raised button	Black		3SB30 00-0BA11	1 unit		
		Red		3SB30 00-0BA21	1 unit		
		Yellow		3SB30 00-0BA31	1 unit		
		Green		3SB30 00-0BA41	1 unit		
		Blue		3SB30 00-0BA51	1 unit		
		White		3SB30 00-0BA61	1 unit		
		Off	Red		3SB30 00-0BA21-ZEC		
		Stop	Red		3SB30 00-0BA21-ZEK		
			Push buttons with raised button, maintained by pressing in and turning to the right, unlatches by turning to the left	Black		3SB30 00-0CA11	1 unit
				Red		3SB30 00-0CA21	1 unit
	Push buttons with raised front ring (height 13 mm)	Black		3SB30 00-0AA12	1 unit		
		Red		3SB30 00-0AA22	1 unit		
		Yellow		3SB30 00-0AA32	1 unit		
		Green		3SB30 00-0AA42	1 unit		
		Blue		3SB30 00-0AA52	1 unit		
		White		3SB30 00-0AA62	1 unit		
	Push buttons with raised front ring, castellated (height 13 mm)	Black		3SB30 00-0AA13	1 unit		
		Red		3SB30 00-0AA23	1 unit		
		Yellow		3SB30 00-0AA33	1 unit		
		Green		3SB30 00-0AA43	1 unit		
		Blue		3SB30 00-0AA53	1 unit		
		White		3SB30 00-0AA63	1 unit		
	Illuminated push buttons with flat button (incl. holder for 3 elements)	Amber ²⁾		3SB30 01-0AA01	1 unit		
		Red ²⁾		3SB30 01-0AA21	1 unit		
		Yellow ²⁾		3SB30 01-0AA31	1 unit		
		Green ²⁾		3SB30 01-0AA41	1 unit		
		Blue ²⁾		3SB30 01-0AA51	1 unit		
		White		3SB30 01-0AA61	1 unit		
Clear ²⁾		3SB30 01-0AA71	1 unit				
	Illuminated push buttons with raised button (incl. holder for 3 elements)	Red		3SB30 01-0BA21	1 unit		
		Yellow		3SB30 01-0BA31	1 unit		
		Green		3SB30 01-0BA41	1 unit		
		Blue		3SB30 01-0BA51	1 unit		
		Clear		3SB30 01-0BA71	1 unit		
	Push buttons with flat button, maintained , unlatches by pressing again	Black		3SB30 00-0DA11	1 unit		
		Red		3SB30 00-0DA21	1 unit		
		Yellow		3SB30 00-0DA31	1 unit		
		Green		3SB30 00-0DA41	1 unit		
		Blue		3SB30 00-0DA51	1 unit		
		White		3SB30 00-0DA61	1 unit		
		Gray		3SB30 00-0DB51	1 unit		
	Illuminated push buttons with flat button, maintained , unlatches by pressing again (incl. holder for 3 elements)	Red ²⁾		3SB30 01-0DA21	1 unit		
		Yellow ²⁾		3SB30 01-0DA31	1 unit		
		Green ²⁾		3SB30 01-0DA41	1 unit		
		Blue ²⁾		3SB30 01-0DA51	1 unit		
		White		3SB30 01-0DA61	1 unit		
		Clear ²⁾		3SB30 01-0DA71	1 unit		

 For online configurator see www.siemens.com/sirius/configurators.

¹⁾ Also available without holder. Supplement Order No. with "-Z" and quote order code "B01". Price reduction on request.

²⁾ Inscription is possible by inserting a label.

Push Button Units and Indicator Lights

3SB3, Plastic, Round, 22 mm

Actuators and Indicators

1
2
3
4
5
6
7
8
9
10

Version	Color of handle	DT	Configurator 	PS
			Order No.	

Mushroom push buttons with holder¹⁾²⁾



Mushroom push buttons, Ø 30 mm

Black
Red
Yellow
Green

3SB30 00-1DA11
3SB30 00-1DA21
3SB30 00-1DA31
3SB30 00-1DA41

1 unit
1 unit
1 unit
1 unit



Mushroom push buttons, Ø 40 mm

Black
Red
Yellow
Green

3SB30 00-1GA11
3SB30 00-1GA21
3SB30 00-1GA31
3SB30 00-1GA41

1 unit
1 unit
1 unit
1 unit



Mushroom push buttons, Ø 60 mm

Black
Red
Yellow
Green

3SB30 00-1QA11
3SB30 00-1QA21
3SB30 00-1QA31
3SB30 00-1QA41

1 unit
1 unit
1 unit
1 unit



Illuminated mushroom push buttons, Ø 30 mm (incl. holder for 3 elements)

Red
Yellow
Green
Blue
White
Clear

3SB30 01-1DA21
3SB30 01-1DA31
3SB30 01-1DA41
3SB30 01-1DA51
3SB30 01-1DA61
3SB30 01-1DA71

1 unit
1 unit
1 unit
1 unit
1 unit
1 unit



Illuminated mushroom push buttons, Ø 40 mm (incl. holder for 3 elements)

Yellow
Green
White

3SB30 01-1GA31
3SB30 01-1GA41
3SB30 01-1GA61

1 unit
1 unit
1 unit

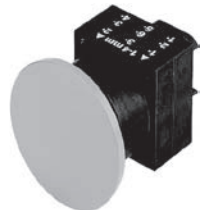

Push-pull buttons, Ø 30 mm, maintained, pull to unlatch

Black
Red

3SB30 00-1EA11
3SB30 00-1EA21

1 unit
1 unit



Push-pull buttons, Ø 40 mm, maintained, pull to unlatch

Black
Red

3SB30 00-1CA11
3SB30 00-1CA21

1 unit
1 unit



Push-pull buttons, Ø 60 mm, maintained, pull to unlatch

Black
Red

3SB30 00-1RA11
3SB30 00-1RA21

1 unit
1 unit

Push-pull buttons, Ø 30 mm, can be illuminated, maintained, pull to unlatch, (incl. holder for 3 elements)

Red
Yellow
Green
Blue
Clear

3SB30 01-1EA21
3SB30 01-1EA31
3SB30 01-1EA41
3SB30 01-1EA51
3SB30 01-1EA71

1 unit
1 unit
1 unit
1 unit
1 unit

Push-pull buttons, Ø 40 mm, can be illuminated, maintained, pull to unlatch (incl. holder for 3 elements)

Red
Yellow
Green
Blue
Clear

3SB30 01-1CA21
3SB30 01-1CA31
3SB30 01-1CA41
3SB30 01-1CA51
3SB30 01-1CA71

1 unit
1 unit
1 unit
1 unit
1 unit

 For online configurator see www.siemens.com/sirius/configurators.

¹⁾ Also available without holder. Supplement Order No. with "-Z" and quote order code "B01". Price reduction on request.

²⁾ Maximum permissible equipment: 3 single-pole or 2 double-pole contact blocks. When using the 3SB39 01-0AB holder, the central command point must not be empty.

Push Button Units and Indicator Lights

3SB3, Plastic, Round, 22 mm

Actuators and Indicators

Version	Version Illumination	Color of handle	DT	Configurator 	PS
				Order No.	

Selector switches with holder¹⁾

Selector switches with 2 switch positions



Non-illuminated

Switching sequence O-I,
90° operating angle,
maintained



Non-illuminated

Black
Red
Green
White

3SB30 00-2HA11
3SB30 00-2HA21
3SB30 00-2HA41
3SB30 00-2HA61

1 unit
1 unit
1 unit
1 unit

Illuminated

(incl. holder for 3
elements)

Red
Yellow
Green
Blue
Clear

3SB30 01-2HA21
3SB30 01-2HA31
3SB30 01-2HA41
3SB30 01-2HA51
3SB30 01-2HA71

1 unit
1 unit
1 unit
1 unit
1 unit



Illuminated

Switching sequence O-I,
50° operating angle,
maintained



Non-illuminated

Black
Red
Green
White

3SB30 00-2KA11
3SB30 00-2KA21
3SB30 00-2KA41
3SB30 00-2KA61

1 unit
1 unit
1 unit
1 unit

Illuminated

(incl. holder for 3
elements)

Red
Yellow
Green
Blue
Clear

3SB30 01-2KA21
3SB30 01-2KA31
3SB30 01-2KA41
3SB30 01-2KA51
3SB30 01-2KA71

1 unit
1 unit
1 unit
1 unit
1 unit

Switching sequence O-I,
50° operating angle,
momentary, spring apart from right



Non-illuminated

Black
Red
Green
White

3SB30 00-2LA11
3SB30 00-2LA21
3SB30 00-2LA41
3SB30 00-2LA61

1 unit
1 unit
1 unit
1 unit

Illuminated

(incl. holder for 3
elements)

Red
Yellow
Green
Blue
Clear

3SB30 01-2LA21
3SB30 01-2LA31
3SB30 01-2LA41
3SB30 01-2LA51
3SB30 01-2LA71

1 unit
1 unit
1 unit
1 unit
1 unit

Selector switches with 3 switch positions



Non-illuminated

Switching sequence I-O-II,
2 x 50° operating angle,
maintained



Non-illuminated

Black
Red
Green
White

3SB30 00-2DA11
3SB30 00-2DA21
3SB30 00-2DA41
3SB30 00-2DA61

1 unit
1 unit
1 unit
1 unit

Illuminated

(incl. holder for 3
elements)

Red
Yellow
Green
Blue
Clear

3SB30 01-2DA21
3SB30 01-2DA31
3SB30 01-2DA41
3SB30 01-2DA51
3SB30 01-2DA71

1 unit
1 unit
1 unit
1 unit
1 unit



Illuminated

Switching sequence I-O-II,
2 x 50° operating angle,
momentary, spring return from left
and right



Non-illuminated

Black
Red
Green
White

3SB30 00-2EA11
3SB30 00-2EA21
3SB30 00-2EA41
3SB30 00-2EA61

1 unit
1 unit
1 unit
1 unit

Illuminated

(incl. holder for 3
elements)

Red
Yellow
Green
Blue
Clear

3SB30 01-2EA21
3SB30 01-2EA31
3SB30 01-2EA41
3SB30 01-2EA51
3SB30 01-2EA71

1 unit
1 unit
1 unit
1 unit
1 unit

Switching sequence I-O-II,
2 x 50° operating angle,
momentary to the left, spring return
to the left, maintained to the right



Non-illuminated

Black
Red
Green
White

3SB30 00-2GA11
3SB30 00-2GA21
3SB30 00-2GA41
3SB30 00-2GA61

1 unit
1 unit
1 unit
1 unit

Illuminated

(incl. holder for 3
elements)

Red
Yellow
Green
Blue
Clear

3SB30 01-2GA21
3SB30 01-2GA31
3SB30 01-2GA41
3SB30 01-2GA51
3SB30 01-2GA71

1 unit
1 unit
1 unit
1 unit
1 unit

Switching sequence I-O-II,
2 x 50° operating angle,
maintained to the left, momentary to
the right, spring return from the right



Non-illuminated

Black
Red
Green
White

3SB30 00-2FA11
3SB30 00-2FA21
3SB30 00-2FA41
3SB30 00-2FA61

1 unit
1 unit
1 unit
1 unit

Illuminated

(incl. holder for 3
elements)

Red
Yellow
Green
Blue
Clear

3SB30 01-2FA21
3SB30 01-2FA31
3SB30 01-2FA41
3SB30 01-2FA51
3SB30 01-2FA71

1 unit
1 unit
1 unit
1 unit
1 unit

 For online configurator see www.siemens.com/sirius/configurators.

¹⁾ Also available without holder. Supplement Order No. with "-Z" and quote order code "B01". Price reduction on request.

Push Button Units and Indicator Lights

3SB3, Plastic, Round, 22 mm

Actuators and Indicators

Version	Lock version Type	Lock No./ color	Key removal position	DT	Configurator 	PS
					Order No.	

Key-operated switches with holder¹⁾

Key-operated switches with 2 keys, 2 switch positions

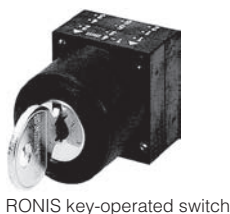

Switching sequence O-I,
50° operating angle,
maintained



Switching sequence O-I,
50° operating angle,
maintained



Switching sequence O-I,
50° operating angle,
momentary, spring return
from the right



Switching sequence O-I,
50° operating angle,
momentary, spring return
from the right



RONIS	SB 30	O+I O I	3SB30 00-4HD11 3SB30 00-4HD01 3SB30 00-4HD21	1 unit 1 unit 1 unit
RONIS	SB 30	O+I O I	3SB30 00-4AD11 3SB30 00-4AD01 3SB30 00-4AD21	1 unit 1 unit 1 unit
CES	SSG 10	O+I O I	3SB30 00-4LD11 3SB30 00-4LD01 3SB30 00-4LD21	1 unit 1 unit 1 unit
	LSG 1	O+I O	3SB30 00-4LF01 3SB30 00-4LF11	1 unit 1 unit
CES with key monitoring ²⁾	SSG 10	O	3SB30 00-4LD05	1 unit
BKS	S1	O+I O I	3SB30 00-5AD11 3SB30 00-5AD01 3SB30 00-5AD21	1 unit 1 unit 1 unit
O.M.R. ³⁾	73038 Light blue	O+I O	3SB30 00-3AG11 3SB30 00-3AG01	1 unit 1 unit
	73037 Red	O+I O	3SB30 00-3AH11 3SB30 00-3AH01	1 unit 1 unit
	73034 Black	O+I O I	3SB30 00-3AJ11 3SB30 00-3AJ01 3SB30 00-3AJ21	1 unit 1 unit 1 unit
	73033 Yellow	O+I O	3SB30 00-3AK11 3SB30 00-3AK01	1 unit 1 unit
RONIS	SB 30	O	3SB30 00-4BD01	1 unit
CES	SSG 10	O	3SB30 00-4MD01	1 unit
	LSG 1	O	3SB30 00-4MF11	1 unit
BKS	S1	O	3SB30 00-5BD01	1 unit
O.M.R. ³⁾	73038 Light blue	O	3SB30 00-3BG01	1 unit
	73037 Red	O	3SB30 00-3BH01	1 unit
	73034 Black	O	3SB30 00-3BJ01	1 unit
	73033 Yellow	O	3SB30 00-3BK01	1 unit

 For online configurator see www.siemens.com/sirius/configurators.

¹⁾ Also available without holder. Supplement Order No. with "-Z" and quote order code "B01". Price reduction on request.

²⁾ For locks with key monitoring the supplied 3SB39 01-0AB holder must be used.

The key scan is performed by a 3SB34 single-pole NC contact block which must be snap-mounted in the center position. Scanning of the switch positions must be performed by additional contact blocks which are snap-mounted on the actuator.

Special locks can be ordered only with order code "Y01".

³⁾ According to FIAT standards; also available for other users.

For BKS and CES special locks see page 10/69.

Push Button Units and Indicator Lights

3SB3, Plastic, Round, 22 mm

Actuators and Indicators

Version	Lock version			DT	Configurator 	PS
	Type	Lock No./ color	Key removal position			
					Order No.	

Key-operated switches with holder¹⁾

Key-operated switches with 2 keys, 3 switch positions

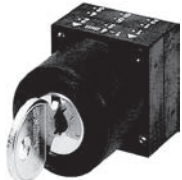

RONIS key-operated switch

Switching sequence I-O-II,
2 x 50° operating angle,
maintained



CES key-operated switch



BKS key-operated switch



O.M.R. key-operated switch

Switching sequence I-O-II,
2 x 50° operating angle,
momentary, spring return from
left and right



Switching sequence I-O-II,
2 x 50° operating angle,
momentary to the left,
spring return from the left,
maintained to the right



Switching sequence I-O-II,
2 x 50° operating angle,
maintained to the left,
momentary to the right,
spring return from the right



RONIS	SB 30	I+O+II O I+II I II O+I	3SB30 00-4DD11 3SB30 00-4DD01 3SB30 00-4DD41 3SB30 00-4DD21 3SB30 00-4DD31 3SB30 00-4DD51	1 unit 1 unit 1 unit 1 unit 1 unit 1 unit
CES	SSG 10	I+O+II O O+I I+II I II	3SB30 00-4PD11 3SB30 00-4PD01 3SB30 00-4PD51 3SB30 00-4PD41 3SB30 00-4PD21 3SB30 00-4PD31	1 unit 1 unit 1 unit 1 unit 1 unit 1 unit
CES with key monitoring	SSG 10	O	3SB30 00-4PD05	1 unit
BKS	S1	I+O+II II O	3SB30 00-5DD11 3SB30 00-5DD31 3SB30 00-5DD01	1 unit 1 unit 1 unit
O.M.R. ³⁾	73038 Light blue	I+O+II O	3SB30 00-3DG11 3SB30 00-3DG01	1 unit 1 unit
	73037 Red	O O+I	3SB30 00-3DH01 3SB30 00-3DH51	1 unit 1 unit
	73034 Black	I+O+II O	3SB30 00-3DJ11 3SB30 00-3DJ01	1 unit 1 unit
	73033 Yellow	I+O+II	3SB30 00-3DK11	1 unit
RONIS	SB 30	O	3SB30 00-4ED01	1 unit
CES	SSG 10	O	3SB30 00-4QD01	1 unit
BKS	S1	O	3SB30 00-5ED01	1 unit
O.M.R. ³⁾	73034 Black	O	3SB30 00-3EJ01	1 unit
	73037 Red	O	3SB30 00-3EH01	
RONIS	SB 30	O + II O II	3SB30 00-4GD61 3SB30 00-4GD01 3SB30 00-4GD31	1 unit 1 unit 1 unit
CES	SSG 10	O + II O	3SB30 00-4SD61 3SB30 00-4SD01	1 unit 1 unit
BKS	S1	O	3SB30 00-5GD01	1 unit
RONIS	SB 30	O+I O I	3SB30 00-4FD51 3SB30 00-4FD01 3SB30 00-4FD21	1 unit 1 unit 1 unit
CES	SSG 10	O+I O I	3SB30 00-4RD51 3SB30 00-4RD01 3SB30 00-4RD21	1 unit 1 unit 1 unit
BKS	S1	O+I O I	3SB30 00-5FD51 3SB30 00-5FD01 3SB30 00-5FD21	1 unit 1 unit 1 unit
O.M.R. ³⁾	73038 Light blue	O	3SB30 00-3FG01	1 unit
	73034 Black	I	3SB30 00-3FJ21	1 unit

 For online configurator see www.siemens.com/sirius/configurators.

¹⁾ Also available without holder. Supplement Order No. with "-Z" and quote order code "B01". Price reduction on request.

²⁾ For locks with key monitoring the supplied 3SB39 01-0AB holder must be used.
The key scan is performed by a 3SB34 single-pole NC contact block which must be snap-mounted in the center position. Scanning of the switch positions must be performed by additional contact blocks which are snap-mounted on the actuator.
Special locks can be ordered only with order code "Y01".

³⁾ According to FIAT standards; also available for other users.

For BKS and CES special locks see page 10/69.

Push Button Units and Indicator Lights

3SB3, Plastic, Round, 22 mm

Actuators and Indicators

1
2
3
4
5
6
7
8
9
10

Version	Color of handle	Approval	DT	Configurator 	PS
				Order No.	

**EMERGENCY-STOP devices according to ISO 13850 and IEC 60947-5-5, with holder¹⁾²⁾.
Can also be used with 3TK28 safety relays.**



Mushroom diameter 32 mm

EMERGENCY-STOP mushroom push buttons, Ø 32 mm,
with positive maintained according to ISO 13850, with rotate-to-unlatch mechanism

Red



3SB30 00-1FA20

1 unit



Mushroom diameter 40 mm,
with rotate-to-unlatch mechanism,
with switch position indication

EMERGENCY-STOP mushroom push buttons, Ø 40 mm,
with positive maintained according to ISO 13850, with rotate-to-unlatch mechanism

Red



3SB30 00-1HA20

1 unit

- Without switch position indicator
- With mechanical switch position indication
- Flat head style

3SB30 00-1HA26

1 unit

3SB30 00-1XA20



Mushroom diameter 40 mm,
pull-to-unlatch mechanism

EMERGENCY-STOP mushroom push buttons, Ø 40 mm,
with positive maintained according to ISO 13850, with pull-to-unlatch mechanism

Red



3SB30 00-1TA20

1 unit



Mushroom diameter 60 mm

EMERGENCY-STOP mushroom push buttons, Ø 60 mm,
with positive maintained according to ISO 13850, with rotate-to-unlatch mechanism

Red



3SB30 00-1AA20

1 unit



Mushroom diameter 40 mm,
with RONIS key-operated switch

EMERGENCY-STOP mushroom push buttons, Ø 40 mm, with RONIS lock,
lock No. SB 30, with positive maintained acc. to ISO 13850,
unlocking only possible using key

Red



3SB30 00-1BA20

1 unit



Mushroom diameter 40 mm,
with CES key-operated switch

EMERGENCY-STOP mushroom push buttons, Ø 40 mm, with CES lock,
lock No. SSG 10, with positive maintained according to ISO 13850,
unlocking only possible using key

Red



3SB30 00-1KA20

1 unit

EMERGENCY-STOP mushroom push buttons, Ø 40 mm, with BKS lock,
lock No. S1, with positive maintained according to ISO 13850,
unlocking only possible using key

Red



3SB30 00-1LA20

1 unit

EMERGENCY-STOP mushroom push buttons, Ø 40 mm, with O.M.R. lock,
lock No. 73037, with positive maintained according to ISO 13850,
unlocking only possible using key

Red



3SB30 00-1MA20

1 unit

EMERGENCY-STOP mushroom push buttons, Ø 40 mm, with "EMO" marking for SEMI S2 compliance
with mechanical maintained function acc. to EN418, turn short handle to left to unlatch

Red (flat)

3SB30 00-1XB80

1 unit

 For online configurator see www.siemens.com/sirius/configurators

1) Also available without holder. Supplement Order No. with "-Z" and quote order code "B01". Price reduction on request.

2) Yellow backing plates must be ordered separately; see "Accessories" on page 10/84..

For BKS and CES special locks see page 10/69.

Push Button Units and Indicator Lights

3SB3, Plastic, Round, 22 mm

Actuators and Indicators

Version	Color of lens	DT	Configurator 	PS
			Order No.	

Signaling elements with holder¹⁾



Indicator light with concentric rings

Indicator lights with smooth lens ²⁾	Amber	3SB30 01-6AA00	1 unit
	Red	3SB30 01-6AA20	1 unit
	Yellow	3SB30 01-6AA30	1 unit
	Green	3SB30 01-6AA40	1 unit
	Blue	3SB30 01-6AA50	1 unit
	White	3SB30 01-6AA60	1 unit
	Clear	3SB30 01-6AA70	1 unit

Indicator lights with lens with concentric rings ²⁾	Amber	3SB30 01-6BA00	1 unit
	Red	3SB30 01-6BA20	1 unit
	Yellow	3SB30 01-6BA30	1 unit
	Green	3SB30 01-6BA40	1 unit
	Blue	3SB30 01-6BA50	1 unit
	White	3SB30 01-6BA60	1 unit
	Clear	3SB30 01-6BA70	1 unit



Acoustic signaling device

Acoustic signaling devices, IP40³⁾ For acoustic signal transformer 24 V DC ⁴⁾ (without BA 9s base)	Black	3SB30 00-7AA10	1 unit
---	-------	-----------------------	--------

 For online configurator see www.siemens.com/sirius/configurators.

¹⁾ Also available without holder. Supplement Order No. with **"-Z"** and quote order code **"B01"**. Price reduction on request.

²⁾ Inscription by inserting a label is not possible.

³⁾ For acoustic signaling devices, IP65, see **"Complete Units"**.

⁴⁾ Following must be ordered separately:

- 3SB1902-2BN acoustic signal transformer, see **"Accessories"**.

- 3SB34 00-1A lamp holder for front plate mounting or

3SB34 20-1A lamp holder for base mounting, both with screw terminals.

Devices assembled in this way are suitable for use in enclosures.

Lamp holders with spring-type terminals cannot be used.

Version	Inscriptions	Color of handle	DT	Configurator 	PS
				Order No.	

Twin push buttons with indicator light with holder¹⁾²⁾



Twin push button with indicator light, with flat buttons

Twin push buttons with indicator light, IP65 with flat, square buttons, incl. holder for 3 elements	I/O ³⁾	Green/Red	3SB31 01-8BC21	1 unit
	I/O ³⁾	White/Black	3SB31 01-8BC31	1 unit
	↑ / ↓ ³⁾	Green/Red	3SB31 01-8BC81	1 unit



Twin push buttons with indicator light, with flat and raised buttons

Twin push buttons with indicator light, IP65 with flat and raised, square buttons, incl. holder for 3 elements	I/O ³⁾	Green/Red	3SB31 01-8DC21	1 unit
	I/O ³⁾	White/Black	3SB31 01-8DC31	1 unit

 For online configurator see www.siemens.com/sirius/configurators.

¹⁾ Mounting the twin push buttons in 3SB38 enclosure is not possible.

²⁾ Also available without holder. Supplement Order No. with **"-Z"** and quote order code **"B01"**. Price reduction on request.

³⁾ Black inscription for green, red and white

Push Button Units and Indicator Lights

3SB3, Plastic, Round, 22 mm

Actuators and Indicators

Version	Inscriptions	Color of handle	DT	Configurator	PS
---------	--------------	-----------------	----	--------------	----

Order No.

Twin push buttons with holder¹⁾²⁾



Twin push button with flat buttons

Twin push buttons, IP65 with flat, square buttons	I/O ³⁾	Green/Red	DT	3SB31 00-8AC21	1 unit
	I/O ³⁾	White/Black			3SB31 00-8AC31
Twin push buttons, IP65 with flat and raised, square buttons	↑ / ↓ ³⁾	White/White	DT	3SB31 00-8AC61-0AD0	1 unit
	I/O ³⁾	Green/Red			3SB31 00-8CC21
	I/O ³⁾	White/Black		3SB31 00-8CC31	1 unit

⚙️ For online configurator see www.siemens.com/sirius/configurators.

- 1) Mounting the twin push buttons in 3SB38 enclosure is not possible.
- 2) Also available without holder. Supplement Order No. with "-Z" and quote order code "B01". Price reduction on request.
- 3) Black inscription for green, red and white buttons;
white inscription on black button.

Version	Use	DT	Order No.	PS
---------	-----	----	-----------	----

Accessories for twin push buttons



Label holder

Label holders 70 mm x 30 mm for inscription label 12.5 mm x 27 mm ¹⁾	Twin push buttons	DT	3SB39 22-0AY	5 units
--	-------------------	----	---------------------	---------



Protective cap

Protective caps, clear Silicone, for degree of protection IP67	Twin push buttons with flat buttons	DT	3SB39 21-0AQ	1 unit
--	--	----	---------------------	--------

- 1) Mounting in 3SB38 enclosure is not possible.
For inscription labels see pages 10/75 and 10/76.

Push Button Units and Indicator Lights

3SB3, Plastic, Round, 22 mm

Coordinate switches, complete

Overview

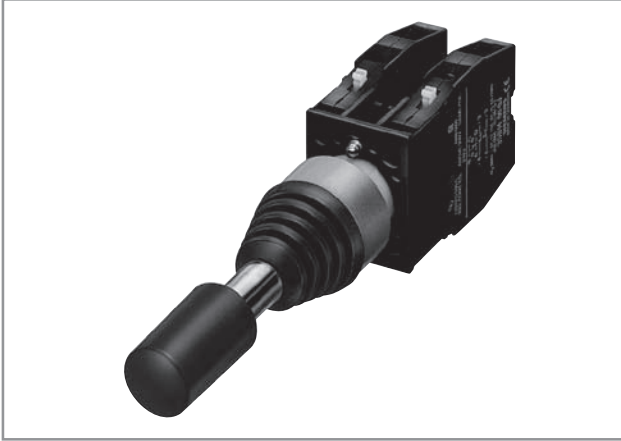

Coordinate switch with contact blocks

Coordinate switches control auxiliary circuits permitting movements in various directions of machines and equipment.

The switches are designed for front panel mounting. They are climate-proof.

Operation

The 3SB14 00-0J contact block is used, which due to its depth cannot be built into 3SB38 enclosures.

Switches are available as follows:

- With 2 or 4 switch positions
- Latching or momentary contact type
- With or without mechanical interlocking

In the case of switches with mechanical interlock in O position, the switch is unlatched with the unlatching button at the front of the actuating lever.

Inscriptions

A name plate consisting of a black, plastic label holder and two or four adhesive, silver-colored inscription labels of 27 mm x 27 mm in size is available for labeling purposes. These labels can be supplied with and without customized inscription.

Note mounting dimensions!

Selection and ordering data

Version	Operating travel <input type="checkbox"/> Contact closed <input type="checkbox"/> Contact open	DT	Screw terminals	PU (UNIT, SET, M)	PS
			Order No.		

Coordinate switches

2 switch positions, 1 NO per direction

Horizontal, momentary contact type

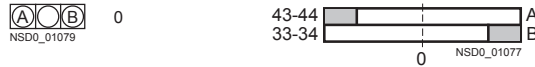

Without mechanical interlocking in the O position

- With plastic front ring, black
- With metal front ring

With mechanical interlocking in the O position

- With plastic front ring, black
- With metal front ring

Vertical, momentary contact type

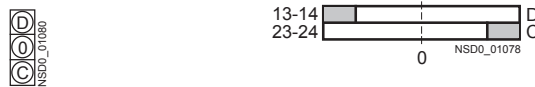

Without mechanical interlocking in the O position

- With plastic front ring, black
- With metal front ring

With mechanical interlocking in the O position

- With plastic front ring, black
- With metal front ring

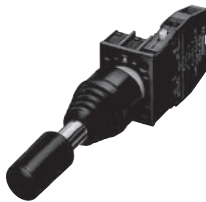

Coordinate switch,
2 switch positions

C	3SB12 01-7DV01	1	1 unit
C	3SB12 01-7DV20	1	1 unit

C	3SB12 01-7DW01	1	1 unit
C	3SB12 01-7DW20	1	1 unit

C	3SB12 01-7FV01	1	1 unit
C	3SB12 01-7FV20	1	1 unit

C	3SB12 01-7FW01	1	1 unit
C	3SB12 01-7FW20	1	1 unit

Push Button Units and Indicator Lights

3SB3, Plastic, Round, 22 mm

Coordinate switches, complete

Version	Operating travel	DT	Screw terminals 	PS
	<input checked="" type="checkbox"/> Contact closed <input type="checkbox"/> Contact open		Order No.	

Coordinate switches

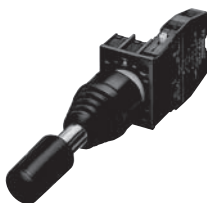

Coordinate switch,
2 switch positions

2 switch positions, 1 NO per direction

Horizontal, maintained

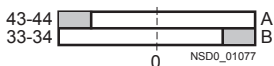

Without mechanical interlocking in the O position

- With plastic front ring, black
- With metal front ring

With mechanical interlocking in the O position

- With plastic front ring, black
- With metal front ring

Vertical, maintained

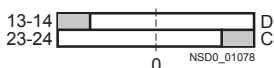

Without mechanical interlocking in the O position

- With plastic front ring, black
- With metal front ring

With mechanical interlocking in the O position

- With plastic front ring, black
- With metal front ring

4 switch positions, 1 NO per direction

Momentary contact type

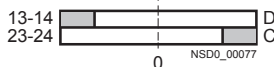
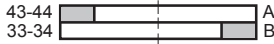
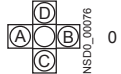

Without mechanical interlocking in the O position

- With plastic front ring, black
- With metal front ring

With mechanical interlocking in the O position

- With plastic front ring, black
- With metal front ring

Latching

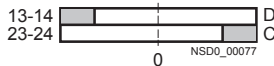
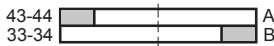
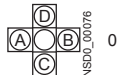

Without mechanical interlocking in the O position

- With plastic front ring, black
- With metal front ring

With mechanical interlocking in the O position

- With plastic front ring, black
- With metal front ring

3SB12 01-7EV01	1 unit
3SB12 01-7EV20	1 unit

3SB12 01-7EW01	1 unit
3SB12 01-7EW20	1 unit

3SB12 01-7GV01	1 unit
3SB12 01-7GV20	1 unit

3SB12 01-7GW01	1 unit
3SB12 01-7GW20	1 unit

3SB12 08-7JV01	1 unit
3SB12 08-7JV20	1 unit

3SB12 08-7JW01	1 unit
3SB12 08-7JW20	1 unit

3SB12 08-7KV01	1 unit
3SB12 08-7KV20	1 unit

3SB12 08-7KW01	1 unit
3SB12 08-7KW20	1 unit

Push Button Units and Indicator Lights

3SB3, Plastic, Round, 22 mm

Coordinate switches, complete

Accessories

Version Contact blocks	Symbols/ operating travel <input type="checkbox"/> Contact closed <input type="checkbox"/> Contact open	DT	Screw terminals 	PS
			Order No.	

Spare contact blocks



3SB14 00-0J

Contact blocks with 2 contacts
1 NO, 1 NO
(included in scope of supply of switch)

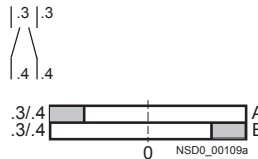

3SB14 00-0J	1 unit
--------------------	--------

Version	DT	Order No.	PS
---------	----	-----------	----

Name plates



3SB19 06-0AV

Label holders for coordinate switches

- 2 switch positions, horizontal, 89 mm × 30 mm
- 2 switch positions, vertical, 30 mm × 89 mm
- 4 switch positions

Inscription labels 27 mm × 27 mm, silver-colored, for sticking in place

- Without inscription
- With inscription (engraved)
 - Text lines (up to 5 lines each with 11 characters)
 - Graphic symbol with number according to ISO 7000 or IEC 60417
 - Any inscription or symbol

3SB19 06-0AU	1 unit
3SB19 06-0AV	1 unit
3SB19 06-0AW	1 unit

3SB19 06-2AA	1 unit
3SB19 06-2XZ	
K0Y, K1Y, K2Y, or K5Y	1 unit
K3Y	1 unit
K9Y	1 unit

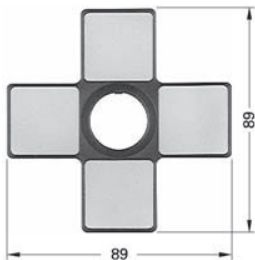

3SB19 06-0AW

For black plastic labels [see page 10/76](#).

Options

Customized inscriptions

These labeling plates can be inscribed with text or symbols. 5 lines with 11 characters each in a letter height of 4 mm are possible.

Ordering notes

Append the following order codes to the Order No.:

- Text line(s) in upper/lower case, upper case always for beginning of line (e.g. "Lift off"): **K0Y**
- Text line(s) in upper case (e.g. "LIFT OFF"): **K1Y**
- Text line(s) in lower case (e.g. "lift off"): **K2Y**
- Text line(s) in upper/lower case, all words begin with upper case letters (e.g. "Lift Off"): **K5Y**
- Symbol with number according to ISO 7000 or IEC 60417: **K3Y**
- Any inscription or symbol according to order form supplement: **K9Y**

When ordering, specify the required inscription in plain text in addition to the order number and order code. In the case of special inscriptions with words in languages other than German, give the exact spelling and specify the language.

In the case of multi-line inscriptions, the text must be assigned to the respective line, e.g. "Z1 = Lift, Z2 = Lower".

Symbols can also be ordered with numbers according to ISO 7000 or IEC 60417.

For special symbols (order code K9Y), a CAD drawing in DXF format can be submitted.

Ordering example

A label inscribed with symbol No. 1117 according to ISO 7000 is required:

3SB19 06-2XZ
K3Y
Z = 1117 ISO

For other ordering examples [see page 10/72](#).



Push Button Units and Indicator Lights

3SB3, Plastic, Square, 22 mm

Complete Units

1
2
3
4
5
6
7
8
9
10

Selection and ordering data

Version	Rated voltage of lamp	Color of handle	Contacts for front plate mounting	DT	Screw terminals 	PS
					Configurator 	
	V				Order No.	

Push buttons



Push button



Illuminated push button

Version	Rated voltage of lamp	Color of handle	Contacts for front plate mounting	DT	Screw terminals 	PS
Push buttons with flat button	—	Black	1 NO		3SB33 02-0AA11	1 unit
		Black	1 NC		3SB33 03-0AA11	1 unit
		Red	1 NC		3SB33 03-0AA21	1 unit
		Yellow	1 NO		3SB33 02-0AA31	1 unit
		Green	1 NO		3SB33 02-0AA41	1 unit
		Blue	1 NO		3SB33 02-0AA51	1 unit
		White	1 NO		3SB33 02-0AA61	1 unit
		Black	1 NO + 1 NC		3SB33 01-0AA11	1 unit
		Red	1 NO + 1 NC		3SB33 01-0AA21	1 unit
		Yellow	1 NO + 1 NC		3SB33 01-0AA31	1 unit
		Green	1 NO + 1 NC		3SB33 01-0AA41	1 unit
		Blue	1 NO + 1 NC		3SB33 01-0AA51	1 unit
		White	1 NO + 1 NC		3SB33 01-0AA61	1 unit
Illuminated push buttons with flat button with integrated LED (incl. holder for 3 elements)	24 AC/DC	Red ¹⁾	1 NC		3SB33 46-0AA21	1 unit
		Yellow ¹⁾	1 NO		3SB33 45-0AA31	1 unit
		Green ¹⁾	1 NO		3SB33 45-0AA41	1 unit
		Blue ¹⁾	1 NO		3SB33 45-0AA51	1 unit
		White	1 NO		3SB33 45-0AA61	1 unit
		Clear ¹⁾	1 NO		3SB33 45-0AA71	1 unit
		Red ¹⁾	1 NO + 1 NC		3SB33 47-0AA21	1 unit
		Yellow ¹⁾	1 NO + 1 NC		3SB33 47-0AA31	1 unit
		Green ¹⁾	1 NO + 1 NC		3SB33 47-0AA41	1 unit
		Blue ¹⁾	1 NO + 1 NC		3SB33 47-0AA51	1 unit
		White	1 NO + 1 NC		3SB33 47-0AA61	1 unit
		Clear ¹⁾	1 NO + 1 NC		3SB33 47-0AA71	1 unit
Illuminated push buttons with flat button with integrated LED (incl. holder for 3 elements)	230 AC	Red ¹⁾	1 NC		3SB33 54-0AA21	1 unit
		Yellow ¹⁾	1 NO		3SB33 53-0AA31	1 unit
		Green ¹⁾	1 NO		3SB33 53-0AA41	1 unit
		Blue ¹⁾	1 NO		3SB33 53-0AA51	1 unit
		White	1 NO		3SB33 53-0AA61	1 unit
		Clear ¹⁾	1 NO		3SB33 53-0AA71	1 unit
		Red ¹⁾	1 NO + 1 NC		3SB33 55-0AA21	1 unit
		Yellow ¹⁾	1 NO + 1 NC		3SB33 55-0AA31	1 unit
		Green ¹⁾	1 NO + 1 NC		3SB33 55-0AA41	1 unit
		Blue ¹⁾	1 NO + 1 NC		3SB33 55-0AA51	1 unit
		White	1 NO + 1 NC		3SB33 55-0AA61	1 unit
		Clear ¹⁾	1 NO + 1 NC		3SB33 55-0AA71	1 unit
Illuminated push buttons with flat button with BA 9s lamp holder without lamp (incl. holder for 3 elements)		Red ¹⁾	1 NC		3SB33 07-0AA21	1 unit
		Yellow ¹⁾	1 NO		3SB33 06-0AA31	1 unit
		Green ¹⁾	1 NO		3SB33 06-0AA41	1 unit
		Blue ¹⁾	1 NO		3SB33 06-0AA51	1 unit
		White	1 NO		3SB33 06-0AA61	1 unit
		Clear ¹⁾	1 NO		3SB33 06-0AA71	1 unit
		Red ¹⁾	1 NO + 1 NC		3SB33 05-0AA21	1 unit
		Yellow ¹⁾	1 NO + 1 NC		3SB33 05-0AA31	1 unit
		Green ¹⁾	1 NO + 1 NC		3SB33 05-0AA41	1 unit
		Blue ¹⁾	1 NO + 1 NC		3SB33 05-0AA51	1 unit
		White	1 NO + 1 NC		3SB33 05-0AA61	1 unit
		Clear ¹⁾	1 NO + 1 NC		3SB33 05-0AA71	1 unit



 For online configurator see www.siemens.com/sirius/configurators.

¹⁾ Inscription is possible by inserting a label.

Push Button Units and Indicator Lights

3SB3, Plastic, Square, 22 mm

Complete units

Version	Color of handle	Contacts for front plate mounting	DT	Screw terminals 	PS
				Configurator 	
				Order No.	

EMERGENCY-STOP devices acc. to ISO 13850, with yellow name plate, Ø 80 mm, with inscription¹⁾. Can also be used with 3TK28 safety relays.

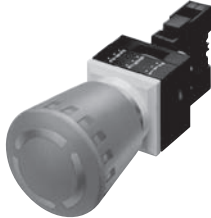

EMERGENCY-STOP mushroom push buttons, Ø 40 mm, with positive maintained function, with rotate-to-unlatch mechanism

Red

1 NC



1 NO + 1 NC



3SB33 03-1HA20

1 unit

3SB33 01-1HA20

1 unit



EMERGENCY-STOP mushroom push button with rotate-to-unlatch mechanism

 For online configurator see www.siemens.com/sirius/configurators.

 Positive opening according to IEC 60947-5-1, Appendix K. Can be used with 3TK28 safety relays. Certificate:



¹⁾ German inscription "NOT-HALT".

Version	Rated voltage of lamp	Color of lens	DT	Screw terminals 	PS
				Configurator 	
				Order No.	

V

Signaling devices



Indicator light

Indicator lights with integrated LED

24 AC/DC

Red
Yellow
Green
Blue
White
Clear

3SB33 44-6AA20
3SB33 44-6AA30
3SB33 44-6AA40
3SB33 44-6AA50
3SB33 44-6AA60
3SB33 44-6AA70

1 unit
1 unit
1 unit
1 unit
1 unit
1 unit

Indicator lights with integrated LED

230 AC

Red
Yellow
Green
Blue
White
Clear

3SB33 52-6AA20
3SB33 52-6AA30
3SB33 52-6AA40
3SB33 52-6AA50
3SB33 52-6AA60
3SB33 52-6AA70

1 unit
1 unit
1 unit
1 unit
1 unit
1 unit

Indicator lights with BA 9s lamp holder (without lamp)

–

Red
Yellow
Green
Blue
White
Clear

3SB33 04-6AA20
3SB33 04-6AA30
3SB33 04-6AA40
3SB33 04-6AA50
3SB33 04-6AA60
3SB33 04-6AA70

1 unit
1 unit
1 unit
1 unit
1 unit
1 unit

 For online configurator see www.siemens.com/sirius/configurators.

Push Button Units and Indicator Lights

3SB3, Plastic, Square, 22 mm

Actuators and Indicators

1
2
3
4
5
6
7
8
9
10

Selection and ordering data

Version	Color of handle	DT	Configurator 	PS			
			Order No.				
Push buttons and switches with holder¹⁾							
 Push button	Push buttons with flat button	Black Red Yellow Green Blue White Clear ²⁾	3SB31 10-0AA11 3SB31 10-0AA21 3SB31 10-0AA31 3SB31 10-0AA41 3SB31 10-0AA51 3SB31 10-0AA61 3SB31 10-0AA71	1 unit 1 unit 1 unit 1 unit 1 unit 1 unit 1 unit			
	 Push button with raised front ring	Push buttons with raised front ring (height 13 mm)	Black Red Green White	3SB31 10-0AA12 3SB31 10-0AA22 3SB31 10-0AA42 3SB31 10-0AA62	1 unit 1 unit 1 unit 1 unit		
		 Push button with raised front ring, castellated	Push buttons with raised front ring, castellated (height 13 mm)	Black Red Yellow Green White	3SB31 10-0AA13 3SB31 10-0AA23 3SB31 10-0AA33 3SB31 10-0AA43 3SB31 10-0AA63	1 unit 1 unit 1 unit 1 unit 1 unit	
			 Illuminated push button	Illuminated push buttons with flat button (incl. holder for 3 elements)	Red ²⁾ Yellow ²⁾ Green ²⁾ Blue ²⁾ White Clear ²⁾	3SB31 11-0AA21 3SB31 11-0AA31 3SB31 11-0AA41 3SB31 11-0AA51 3SB31 11-0AA61 3SB31 11-0AA71	1 unit 1 unit 1 unit 1 unit 1 unit 1 unit
				 Push button	Push buttons, maintained, with flat button, unlocking by pressing again	Black Red Yellow Green Blue White	3SB31 10-0DA11 3SB31 10-0DA21 3SB31 10-0DA31 3SB31 10-0DA41 3SB31 10-0DA51 3SB31 10-0DA61
	 Illuminated push button				Illuminated push buttons, maintained, with flat button (incl. holder for 3 elements), unlatches by pressing again,	Red ²⁾ Yellow ²⁾ Green ²⁾ Blue ²⁾ White Clear ²⁾	3SB31 11-0DA21 3SB31 11-0DA31 3SB31 11-0DA41 3SB31 11-0DA51 3SB31 11-0DA61 3SB31 11-0DA71

 For online configurator see www.siemens.com/sirius/configurators.













¹⁾ Also available without holder. Supplement Order No. with "-Z" and quote order code "B01". Price reduction on request.

²⁾ Inscription is possible by inserting a label.

Push Button Units and Indicator Lights

3SB3, Plastic, Square, 22 mm

Actuators and Indicators

Version	Version Illumination	Color of handle	DT	Configurator 	PS
				Order No.	
Selector switches with holder¹⁾					
Selector switches with 2 switch positions					
 Selector switch	Switching sequence O-I, 50° operating angle, maintained 	Non-illuminated	Black	3SB31 10-2KA11	1 unit
			Red	3SB31 10-2KA21	1 unit
			Green	3SB31 10-2KA41	1 unit
			White	3SB31 10-2KA61	1 unit
		Illuminated (incl. holder for 3 elements)	Red	3SB31 11-2KA21	1 unit
	Yellow	3SB31 11-2KA31	1 unit		
	Green	3SB31 11-2KA41	1 unit		
	Blue	3SB31 11-2KA51	1 unit		
	Clear	3SB31 11-2KA71	1 unit		
 Selector switch, illuminated	Switching sequence O-I, 50° operating angle, momentary, spring return from the left 	Non-illuminated	Black	3SB31 10-2LA11	1 unit
			Red	3SB31 10-2LA21	1 unit
			Green	3SB31 10-2LA41	1 unit
			White	3SB31 10-2LA61	1 unit
		Illuminated (incl. holder for 3 elements)	Red	3SB31 11-2LA21	1 unit
	Yellow	3SB31 11-2LA31	1 unit		
	Green	3SB31 11-2LA41	1 unit		
	Blue	3SB31 11-2LA51	1 unit		
	Clear	3SB31 11-2LA71	1 unit		
Selector switches with 3 switch positions					
 Selector switch	Switching sequence I-O-II, 2 x 50° operating angle, maintained 	Non-illuminated	Black	3SB31 10-2DA11	1 unit
			Red	3SB31 10-2DA21	1 unit
			Green	3SB31 10-2DA41	1 unit
			White	3SB31 10-2DA61	1 unit
		Illuminated (incl. holder for 3 elements)	Red	3SB31 11-2DA21	1 unit
	Yellow	3SB31 11-2DA31	1 unit		
	Green	3SB31 11-2DA41	1 unit		
	Blue	3SB31 11-2DA51	1 unit		
	Clear	3SB31 11-2DA71	1 unit		
 Selector switch, illuminated	Switching sequence I-O-II, 2 x 50° operating angle, momentary, spring return from the left and right 	Non-illuminated	Black	3SB31 10-2EA11	1 unit
			Red	3SB31 10-2EA21	1 unit
			Green	3SB31 10-2EA41	1 unit
			White	3SB31 10-2EA61	1 unit
		Illuminated (incl. holder for 3 elements)	Red	3SB31 11-2EA21	1 unit
	Yellow	3SB31 11-2EA31	1 unit		
	Green	3SB31 11-2EA41	1 unit		
	Blue	3SB31 11-2EA51	1 unit		
	Clear	3SB31 11-2EA71	1 unit		
	Switching sequence I-O-II, 2 x 50° operating angle, momentary to the left, spring return from the left, maintained to the right 	Non-illuminated	Black	3SB31 10-2GA11	1 unit
			Green	3SB31 10-2GA41	1 unit
			White	3SB31 10-2GA61	1 unit
	Switching sequence I-O-II, 2 x 50° operating angle, maintained to the left, momentary to the right, spring return from the right 	Non-illuminated	Black	3SB31 10-2FA11	1 unit
			Red	3SB31 10-2FA21	1 unit
			Green	3SB31 10-2FA41	1 unit

 For online configurator see www.siemens.com/sirius/configurators.

¹⁾ Also available without holder. Supplement Order No. with "-Z" and quote order code "B01". Price reduction on request.

Push Button Units and Indicator Lights

3SB3, Plastic, Square, 22 mm

Actuators and Indicators

Version	Lock version			DT	Configurator 	PS
	Type	Lock No./color	Key removal position			
					Order No.	

Key-operated switches with holder¹⁾



RONIS key-operated switch





CES key-operated switch



O.M.R. key-operated switch

Key-operated switches with 2 keys, 2 switch positions

Switching sequence O-I, 50° operating angle, maintained 	RONIS	SB 30	O+I O I	3SB31 10-4AD11 3SB31 10-4AD01 3SB31 10-4AD21	1 unit 1 unit 1 unit	
	CES	SSG 10	O+I O I	3SB31 10-4LD11 3SB31 10-4LD01 3SB31 10-4LD21	1 unit 1 unit 1 unit	
		LSG 1	O+I O	3SB31 10-4LF01 3SB31 10-4LF11	1 unit 1 unit	
BKS	S1		O+I	3SB31 10-5AD11	1 unit	
			O	3SB31 10-5AD01	1 unit	
O.M.R. ²⁾		73037 Red	O	3SB31 10-3AH01	1 unit	
			73034 Black	O+I	3SB31 10-3AJ11	1 unit
				73037 Red	O+I	3SB31 10-3AH11

Switching sequence O-I, 50° operating angle, momentary, spring return from the right 	RONIS	SB 30	O	3SB31 10-4BD01	1 unit
	CES	SSG 10	O	3SB31 10-4MD01	1 unit

Key-operated switches with 2 keys, 3 switch positions

Switching sequence I-O-II, 2 x 50° operating angle, maintained 	RONIS	SB 30	I+O+II	3SB31 10-4DD11	1 unit
	CES	SSG 10	I+O+II	3SB31 10-4PD11	1 unit
			O	3SB31 10-4PD01	1 unit
BKS	S1	O	3SB31 10-5BD01	1 unit	

Switching sequence I-O-II, 2 x 50° operating angle, momentary, spring return from the left and right 	RONIS	SB 30	O	3SB31 10-4ED01	1 unit
	CES	SSG 10	O	3SB31 10-4QD01	1 unit

Switching sequence I-O-II, 2 x 50° operating angle, momentary to the left, spring return from the left, maintained to the right 	CES	SSG 10	O	3SB31 10-4SD01	1 unit
--	-----	--------	---	-----------------------	--------

Switching sequence I-O-II, 2 x 50° operating angle, maintained maintained maintained to the left, momentary to the right, spring return from the right 	CES	SSG 10	O+I	3SB31 10-4RD51	1 unit
---	-----	--------	-----	-----------------------	--------

 For online configurator see www.siemens.com/sirius/configurators.

¹⁾ Also available without holder. Supplement Order No. with **"-Z"** and quote order code **"B01"**. Price reduction on request.

²⁾ According to FIAT standards; also available for other users.

For BKS and CES special locks see page 10/69

Push Button Units and Indicator Lights

3SB3, Plastic, Square, 22 mm

Actuators and Indicators

Version	Color of handle	Approval	DT	Configurator	PS
				Order No.	

**EMERGENCY-STOP devices according to ISO 13850 and IEC 60947-5-5, with holder¹⁾²⁾.
Can also be used with 3TK28 safety relays.**



EMERGENCY-STOP mushroom push button with rotate-to-unlatch mechanism

EMERGENCY-STOP mushroom push buttons, Ø 40 mm, Red
with positive latching according to ISO 13850,
with rotate-to-unlatch mechanism

Red



3SB31 10-1HA20

1 unit



EMERGENCY-STOP mushroom push button with RONIS key-operated switch

EMERGENCY-STOP mushroom push buttons, Ø 40 mm, Red
with RONIS key-operated switch
(with 2 keys), lock No. SB 30,
with positive latching according to ISO 13850,
unlocking only possible using key

Red



3SB31 10-1BA20

1 unit

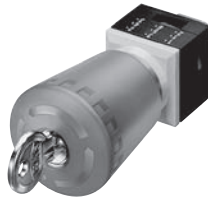

EMERGENCY-STOP mushroom push button with CES key-operated switch

EMERGENCY-STOP mushroom push buttons, Ø 40 mm, Red
with CES key-operated switch
(with 2 keys), lock No. SSG 10,
with positive latching according to ISO 13850,
unlocking only possible using key

Red



3SB31 10-1KA20

1 unit



EMERGENCY-STOP mushroom push button with O.M.R. key-operated switch

EMERGENCY-STOP mushroom push buttons, Ø 40 mm, Red
with BKS key-operated switch
(with 2 keys),
lock No. S1, with positive latching according to ISO 13850,
unlocking only possible using key

Red



3SB31 10-1LA20

1 unit

EMERGENCY-STOP mushroom push buttons, Ø 40 mm, Red
with O.M.R. key-operated switch
(with 2 keys), lock No. 73037
with positive latching according to ISO 13850,
unlocking only using key

Red



3SB31 10-1MA20

1 unit

¹⁾ For online configurator see www.siemens.com/sirius/configurators.

¹⁾ Also available without holder. Supplement Order No. with "-Z" and quote order code "B01". Price reduction on request.

²⁾ Yellow backing plates must be ordered separately; see "Accessories" on page 10/84.

For BKS and CES special locks see page 10/69

Version	Color of lens	DT	Configurator	PS
			Order No.	

Signaling elements with holder¹⁾



Indicator lights

Indicator lights

Red
Yellow
Green
Blue
Clear
White

3SB31 11-6AA20
3SB31 11-6AA30
3SB31 11-6AA40
3SB31 11-6AA50
3SB31 11-6AA70
3SB31 11-6AA60

1 unit
1 unit
1 unit
1 unit
1 unit
1 unit

¹⁾ For online configurator see www.siemens.com/sirius/configurators.

¹⁾ Also available without holder. Supplement Order No. with "-Z" and quote order code "B01". Price reduction on request.



Push Button Units and Indicator Lights

3SB3, Components for Actuators and Indicators, 22 mm













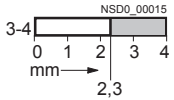

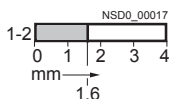

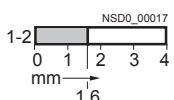

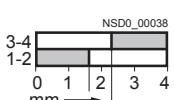

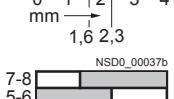
Contact blocks and lamp holders

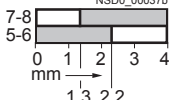
1
2
3
4
5
6
7
8
9
10

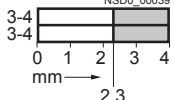
Selection and ordering data

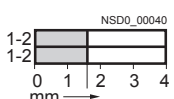
Version	Diagram	Operating travel	DT	Screw terminals	PS
		 Contact closed  Contact open			
				Order No.	

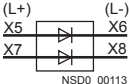
Contact blocks for front plate mounting

 3SB34 00-0B	Contact blocks with one contact • Mounting depth: 50 mm 1 NO 1 NO with gold-plated contacts			3SB34 00-0B 3SB34 00-0BA	1 unit 1 unit
	1 NC 1 NC with gold-plated contacts			3SB34 00-0C 3SB34 00-0CA	1 unit 1 unit
	1 NC with mounting monitoring contact ¹⁾ • Mounting depth: 63 mm			3SB34 00-0M	1 unit
 3SB34 00-0M	Contact block with 2 contacts Mounting depth 63 mm (including unit labeling plate)				
	1 NO + 1 NC 1 NO + 1 NC with gold-plated contacts			3SB34 00-0A 3SB34 00-0AA	1 unit 1 unit
	1 NO + 1 NC with dust protection ²⁾			3SB34 00-0N	1 unit
	1 NO leading + 1 NC lagging 1 NO leading + 1 NC lagging with gold-plated contacts			3SB34 00-0H 3SB34 00-0HA	1 unit 1 unit
	2 NO 2 NO with gold-plated contacts 2 NO with dust protection ²⁾			3SB34 00-0D 3SB34 00-0DA	1 unit 1 unit
	2 NC 2 NC with gold-plated contacts 2 NC with dust protection ²⁾			3SB34 00-0E 3SB34 00-0EA 3SB34 00-0Q	1 unit 1 unit 1 unit
 3SB34 00-2A	Blocks with 2 diodes type 1N 4007 Mounting depth: 63 mm $U_{RMS} = \text{max. } 250 \text{ V}$ $I_{FAV} = 0.8 \text{ A}$ at $T_U = 60 \text{ }^\circ\text{C}$			3SB34 00-2A	1 unit

⊕ Positive opening according to IEC 60947-5-1, Appendix K.













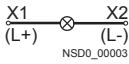

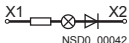

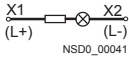
¹⁾ The NC contact opens automatically upon disconnection of the actuator. On delivery, the contact is open (= safe state). Activation (= NC contacts on the non-actuated control device are closed) takes place upon first-time actuation after the contact block is snapped onto the actuator. Not suitable for mounting in 3SB38 enclosures.

²⁾ With 3SB30 01-0CH dust protection shield

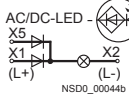
Push Button Units and Indicator Lights

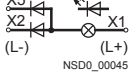
3SB3, Components for Actuators and Indicators, 22 mm

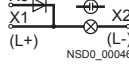
Contact blocks and lamp holders

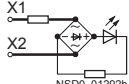
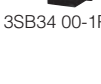
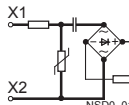
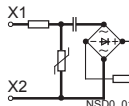
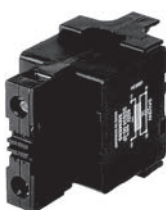
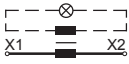
Version	Diagram	Rated voltage	DT	Screw terminals 	PS
		V		Order No.	
Contact blocks for front plate mounting					
	BA 9s lamp holders , mounting depth 50 mm				
	Without lamp With 24 V incandescent lamp (3SX1 344)		Acc. to lamp 24 AC/DC	3SB34 00-1A 3SB34 00-1D	1 unit 1 unit
	BA 9s lamp holders , mounting depth 50 mm				
	With integrated voltage reducer and with 130 V lamp (3SX1 731) ¹⁾		230 / 240 AC	3SB34 00-1C	1 unit
	BA 9s lamp holders , mounting depth 50 mm				
	With built-in resistor for longer endurance and with 130 V lamp (3SX1 731) ¹⁾		110/130 AC/DC	3SB34 00-1B	1 unit
	BA 9s lamp holders with separate lamp test function ²⁾³⁾				
	With integrated voltage reducer and with 130 V lamp (3SX1 731) ¹⁾		230 / 240 AC	3SB34 00-1F	1 unit
	Without lamp				
	For incandescent lamp, max. 2.6 W; for LED lamp, 24/48/230 V AC/DC ⁴⁾		Acc. to lamp	3SB34 00-1G	1 unit
	Without lamp				
	For incandescent lamp, max. 2.6 W; for LED lamp, AC or DC ⁵⁾		Acc. to lamp	3SB34 00-1L	1 unit
	Without lamp				
	For incandescent lamp, max. 2.6 W; for glow lamp, AC		Acc. to lamp	3SB34 00-1H	1 unit
	Lamp holders with integrated LED Mounting depth: 50 mm				
	Yellow Red Green Blue White		24 AC/DC	3SB34 00-1PA 3SB34 00-1PB 3SB34 00-1PC 3SB34 00-1PD 3SB34 00-1PE	1 unit 1 unit 1 unit 1 unit 1 unit
	Yellow Red Green Blue White		110 AC	3SB34 00-1QA 3SB34 00-1QB 3SB34 00-1QC 3SB34 00-1QD 3SB34 00-1QE	1 unit 1 unit 1 unit 1 unit 1 unit
	Yellow Red Green Blue White		230 AC	3SB34 00-1RA 3SB34 00-1RB 3SB34 00-1RC 3SB34 00-1RD 3SB34 00-1RE	1 unit 1 unit 1 unit 1 unit 1 unit
	Transformers For snapping onto 3SB34 00-1A lamp holder		127 / 24 240 / 24 260 / 24 400 / 24	3SB34 00-3A 3SB34 00-3C 3SB34 00-3E 3SB34 00-3F	1 unit 1 unit 1 unit 1 unit
	For incandescent lamp AC, max. 2 W Mounting depth: 97 mm		127 / 6 240 / 6 400 / 6 480 / 6 600 / 6	3SB34 00-3M 3SB34 00-3P 3SB34 00-3S 3SB34 00-3U 3SB34 00-3W	1 unit 1 unit 1 unit 1 unit 1 unit

1) Use these lamps only.

2) The lamp holder with separate lamp test function can not be installed in an enclosure.

3) For circuit examples see Reference manual "Commanding and Signaling Devices".



4) Not suitable for LEDs which are suitable only for AC or DC.

5) Not suitable for LED for 24/48/230 V AC/DC. For connecting to DC, X5 must be connected to L-.













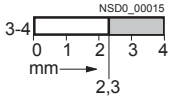

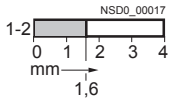

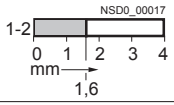

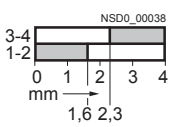

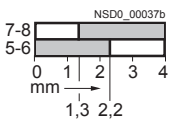

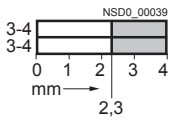

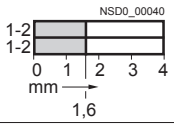
Push Button Units and Indicator Lights

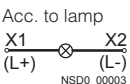
3SB3, Components for Actuators and Indicators, 22 mm

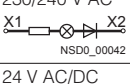
Contact blocks and lamp holders

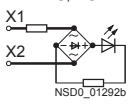
Version	Rated voltage of lamp/ Diagram	Operating travel/color	DT	Spring-type terminals	PS
	V	 Contact closed  Contact open			
				Order No.	

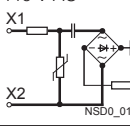
Contact blocks for front plate mounting

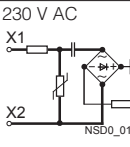
 3SB34 03-0B	Contact blocks with one contact , mounting depth 50 mm					
	1 NO 1 NO with gold-plated contacts			3SB34 03-0B 3SB34 03-0BA	1 unit 1 unit	
 3SB34 03-0C	Contact blocks with one contact , mounting depth 50 mm					
	1 NC 1 NC with gold-plated contacts			3SB34 03-0C 3SB34 03-0CA	1 unit 1 unit	
 3SB34 03-0M	Contact blocks with one contact , mounting depth 63 mm					
	1 NC with mounting monitoring contact ¹⁾ • Mounting depth: 63 mm			3SB34 03-0M	1 unit	
 3SB34 03-0M	Contact blocks with 2 contacts , mounting depth 63 mm					
	1 NO + 1 NC 1 NO + 1 NC with gold-plated contacts			3SB34 03-0A 3SB34 03-0AA	1 unit 1 unit	
 3SB34 03-0A	Contact blocks with 2 contacts , mounting depth 63 mm					
	1 NO leading + 1 NC lagging 1 NO leading + 1 NC lagging with gold-plated contacts			3SB34 03-0H 3SB34 03-0HA	1 unit 1 unit	
 3SB34 03-0A	Contact blocks with 2 contacts , mounting depth 63 mm					
	2 NO 2 NO with gold-plated contacts			3SB34 03-0D 3SB34 03-0DA	1 unit 1 unit	
 3SB34 03-0A	Contact blocks with 2 contacts , mounting depth 63 mm					
	2 NC 2 NC with gold-plated contacts			3SB34 03-0E 3SB34 03-0EA	1 unit 1 unit	
 3SB34 03-1C	BA 9s lamp holders , mounting depth 50 mm					
	Without lamp ²⁾	Acc. to lamp X1 (L+) ⊗ X2 (L-)		3SB34 03-1A	1 unit	
 3SB34 03-1C	BA 9s lamp holders , mounting depth 50 mm					
	With integrated voltage reducer and with 130 V lamp (3SX1 731) ²⁾³⁾	230/240 V AC X1 ⊗ X2		3SB34 03-1C	1 unit	
 3SB3403-1PA	Lamp holders with integrated LED Mounting depth: 50 mm					
	24 V AC/DC		Yellow Red Green Blue White	3SB34 03-1PA 3SB34 03-1PB 3SB34 03-1PC 3SB34 03-1PD 3SB34 03-1PE	1 unit 1 unit 1 unit 1 unit 1 unit	
 3SB3403-1PA	Lamp holders with integrated LED Mounting depth: 50 mm					
	110 V AC		Yellow Red Green Blue White	3SB34 03-1QA 3SB34 03-1QB 3SB34 03-1QC 3SB34 03-1QD 3SB34 03-1QE	1 unit 1 unit 1 unit 1 unit 1 unit	
 3SB3403-1PA	Lamp holders with integrated LED Mounting depth: 50 mm					
	230 V AC		Yellow Red Green Blue White	3SB34 03-1RA 3SB34 03-1RB 3SB34 03-1RC 3SB34 03-1RD 3SB34 03-1RE	1 unit 1 unit 1 unit 1 unit 1 unit	

⊗ Positive opening according to IEC 60947-5-1, Appendix K.

¹⁾ The NC contact opens automatically upon disconnection of the actuator. On delivery, the contact is open (= safe state). For more explanations see footnote, page 10/65. Not suitable for mounting in 3SB38 enclosures.

²⁾ Not suitable for square command devices.

³⁾ Use these lamps only.

Push Button Units and Indicator Lights

3SB3, Components for Actuators and Indicators, 22 mm

Contact blocks and lamp holders

Version	Diagram	Operating travel <input type="checkbox"/> Contact closed <input type="checkbox"/> Contact open	DT	Solder pin connections  Order No.	PS
---------	---------	--	----	--	----

Contact blocks for use on printed circuit boards



3SB34 11-0B

Contact blocks with one contact

Mounting depth 44 mm

1 NO

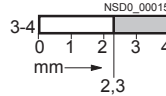

3SB34 11-0B

1 unit

1 NC

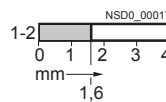

3SB34 11-0C

1 unit



3SB34 11-1A

Wedge base lamp holders W2 x 4.6 d

Mounting depth: 44 mm

Without lamp

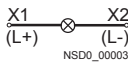

3SB34 11-1A

1 unit

⊕ Positive opening according to IEC 60947-5-1, Appendix K.

Version	DT	Order No.	PS
---------	----	-----------	----

Holders for 3 contact blocks, for front panel mounting



3SB39 01-0AB

Holders for push buttons and switches¹⁾

for snapping on 3 blocks

(for illuminated push buttons and illuminated selector switches the holder is included in the scope of supply)

3SB39 01-0AB

20 units

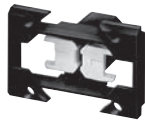

3SB39 01-0AC

Holders for selector switches, key-operated switches and twin push buttons

With pressure plate for actuating the central contact block of 3 contact blocks

3SB39 01-0AC

10 units

Pressure plates for use on printed circuit boards



3SB39 01-0AW

Pressure plates for selector switches and key-operated switches

For actuating the central contact block of 3 contact blocks

3SB39 01-0AW

10 units

Accessories for printed circuit boards

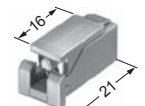

3SB39 01-0AA

Holders for printed circuit boards

for mounting the command devices on the printed circuit board (screw is included in the scope of supply)

3SB39 01-0AA

10 units

¹⁾ Holder also for mushroom push button and push-pull button.

Push Button Units and Indicator Lights

3SB3, Components for Actuators and Indicators, 22 mm

Special locks

1
2
3
4
5
6
7
8
9
10

Options

Special locks for key-operated switches

The BKS and CES plastic and metal key-operated switches, round and square versions, can be optionally equipped with special locks.

In this case the Order No. of the matching key-operated switch must be supplemented with "-Z", the matching order code "Y01" or "Y02" and the required lock number.

Order code	Y01	Y02
In accordance with the table of special locks	No	Yes
Normal delivery time	25 working days	5 working days
Additional price per unit	On request	On request
Ordering example	3SB30 00-4LD01-Z Y01 Z = SSG18	3SB30 00-4LD01-Z Y02 Z = SSG11

Available special locks with order code "Y02"	Order No. with order code
Key-operated switch	
CES SSG 11 to SSG 15	3SB3. ...-4LD01-Z Y02 3SB3. ...-4LD11-Z Y02 3SB3. ...-4LD21-Z Y02 3SB3. ...-4MD01-Z Y02 3SB3. ...-4PD.-Z Y02 3SB3. ...-4QD.-Z Y02 3SB3. ...-4RD.-Z Y02 3SB3. ...-4SD.-Z Y02
BKS E1, E2, E7, E9 ¹⁾	3SB3. ...-5AD.-Z Y02 3SB3. ...-5BD01-Z Y02 3SB3. ...-5DD.-Z Y02 3SB3. ...-5ED01-Z Y02 3SB3. ...-5FD01-Z Y02 3SB3. ...-5GD01-Z Y02
BKS E9 ¹⁾	3SB3. ...-5FD51-Z Y02

EMERGENCY-STOP mushroom push buttons

CES SSP 9	3SB3. ...-1KA20-Z Y02
BKS E2, E7, E9 ¹⁾	3SB3. ...-1LA20-Z Y02

¹⁾ Delivery of these BKS key-operated switches (locks for VW) without key.

Master and master-pass key systems

The following key systems can be supplied with BKS or CES key-operated switches:

- Central lock systems
- Master key systems
- Central master key systems
- Master-pass key systems

When placing an order you must supplement the Order No. of the matching key-operated switches with "-Z" and quote the order code "Y03".

Please enquire for price and delivery time.

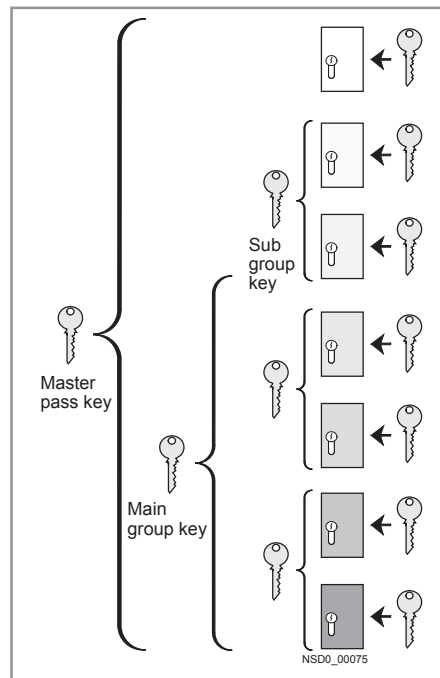

Example of master-pass key system

Ordering notes

- For all special locks, an additional price applies.
- The order code "Y01" or "Y02" must be quoted in accordance with the table above. Automated processing of the order with a defined delivery time can be guaranteed only for correctly submitted orders.
- For applications in which access security is important and several lock numbers are used, we recommend the use of BKS or CES key-operated switches.
- Special locks for VW (E1, E2, ...) will be delivered without keys, all others with 2 keys.

Push Button Units and Indicator Lights

3SB3, Components for Actuators and Indicators, 22 mm

Contact block position for selector switches & 3-position push-pull

Selection and ordering data

Switch Position (front of switch)	Circuit	Contact Block	Block Position ¹⁾²⁾
--------------------------------------	---------	---------------	--------------------------------

Two-Position Selector Contact Block Selection

	O	X	1 NO	3SB34 00-0B	Any Position
	X	O	1 NC	3SB34 00-0C	Any Position
	O	X	1 NO/1 NC	3SB34 00-0A	Any Position
	O	X	2 NO	3SB34 00-0D	Any Position
	X	O	2 NC	3SB34 00-0E	Any Position

Three-Position Selector Contact Block Selection

	X	O	O	1 NO	3SB34 00-0B	1 or 2A
	X	O	X	1 NO	3SB34 00-0B	2
	O	O	X	1 NO	3SB34 00-0B	3 or 2B
	O	X	X	1 NC	3SB34 00-0C	1 or 2A
	O	X	O	1 NC	3SB34 00-0C	2
	X	X	O	1 NC	3SB34 00-0C	3 or 2B
	X	O	O	1 NO/1 NC	3SB34 00-0A	1 or 2A
	X	O	X	1 NO/1 NC	3SB34 00-0A	2
	O	O	X	1 NO/1 NC	3SB34 00-0A	3 or 2B
	X	O	O	2 NO	3SB34 00-0D	1 or 2A
	X	O	X	2 NO	3SB34 00-0D	2
	O	O	X	2 NO	3SB34 00-0D	3 or 2B
	O	X	X	2 NC	3SB34 00-0E	1 or 2A
	O	X	O	2 NC	3SB34 00-0E	2
	X	X	O	2 NC	3SB34 00-0E	3 or 2B
	X	X	O	2 NC	3SB34 00-0E	3 or 2B

Three-Position Push-Pull Contact Block Selection

Out	Center	In	Circuit	Contact Block	Block Position
X	O	O	1 NO	3SB34 00-0B	1 or 2A
O	O	X	1 NO	3SB34 00-0B	3 or 2B
X	X	O	1 NC	3SB34 00-0C	3 or 2B
O	X	X	1 NC	3SB34 00-0C	1 or 2A
O	X	X	1 NO/1 NC	3SB34 00-0A	1 or 2A
X	X	O	1 NO/1 NC	3SB34 00-0A	3 or 2B
O	X	O	1 NO/1 NC	3SB34 00-0A	2
X	O	X	1 NO/1 NC	3SB34 00-0A	2

Rear View of Switch

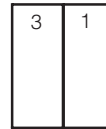

Operator without Contact Block Carrier

For Mounting Contacts Directly to Operator

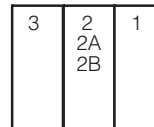

Operator with Contact block carrier

For Mounting Contacts with Carrier

X — Contact Closed
O — Contact Open
2 — Both Pushers Inserted
2A—Left Pusher Inserted
2B—Right Pusher Inserted



3SB39 01-0AC for operating center position. Shown with both pushers inserted (Sold separately)



3SB39 01-0AB included with illuminated devices

Orienting 3-Position Push-Pull Devices

1. Pull the operator to the out position and locate the device orientation mark.
2. With the mark located, insert into panel with the mark on the left side of the device as you face the panel.

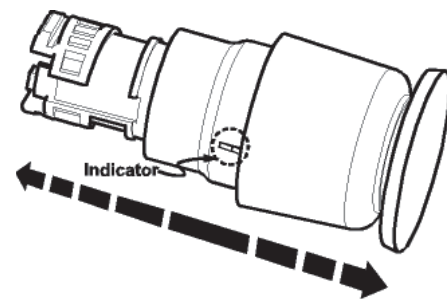

1) Positions 2, 2A and 2B cannot be used on illuminated selector switches. Position is occupied by lamp holder.

2) For illuminated transformer-type devices, an extra-deep lampholder is required when using two-element contact blocks.

Overview

Inscription of actuators and indicators

Actuators and indicators of plastic as well as metal version can be optionally inscribed with a laser.



Pushbutton (metal) with laser inscription

The actuators of the push buttons, illuminated push buttons, mushroom push buttons and illuminated mushroom push buttons can be inscribed as well as the lenses of the indicator lights.

Selector switches can be inscribed only if they are made of plastic (only one text line on the front ring).

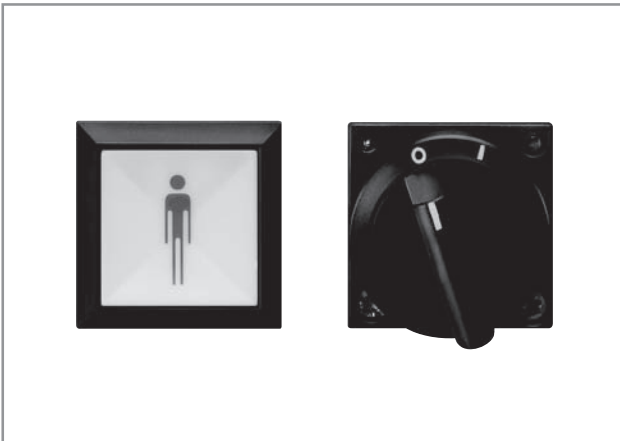

Pushbutton and selector switch (plastic) with laser inscription

Version

A letter height of 4 mm is used as standard for text inscriptions:

The typeface used is Arial. Other letter heights and typefaces are possible, but must be specified when ordering.

For round buttons and lenses, the possible number of characters per line is:

- 10 characters for one line of text
- 8 characters for 2 lines of text
- 6 characters for 3 lines of text, but 10 characters in the middle line

On square buttons and lenses, 10 characters are possible per line.

Ordering notes

When ordering, supplement the Order No. of the actuator or the indicator light with "**-Z**" and an order code:

- Text line in upper/lower case, always upper case for beginning of line (e.g. "Lift off"): **Y10**
- Text in upper case (e.g. "LIFT OFF"): **Y11**
- Text in lower case (e.g. "lift off"): **Y12**
- Text in upper/lower case, all words begin with capital letters (e.g. "Lift Off"): **Y15**
- Symbol with number according to ISO 7000 or IEC 60417: **Y13**
- Any inscription or symbol according to order form supplement: **Y19**

Additional price per unit for Y10 to Y19 on request.

When ordering, specify the required inscription in plain text in addition to the order number and order code. In the case of special inscriptions with words in languages other than German, give the exact spelling and specify the language (see ordering example 1).

In the case of multi-line inscriptions, the text must be assigned to the respective line, e.g. "Z1 = Lift, Z2 =Lower". For long words you can also specify the end-of-line division.

Symbols can also be ordered with numbers according to ISO 7000 or IEC 60417 (see ordering examples 2 and 3).

For special symbols (order code Y19), a CAD drawing in DXF format can be submitted.

Ordering example 1

A round push button with the inscription "Reset" is required:

3SB30 00-0AA41-Z

Y10

Z = Reset (English)

Ordering example 2

A square push button inscribed with symbol No. 5389 according to IEC 60417 is required:

3SB31 10-0AA31-Z

Y13

Z = 5389 IEC

Ordering example 3

A round push button inscribed with symbol No. 1118 according to ISO 7000 is required:

3SB30 00-0AA41-Z

Y13

Z = 1118 ISO

Push Button Units and Indicator Lights

3SB3, Incriptions, 22 mm

Laser inscriptions

Options

Customized inscriptions

The labels can be inscribed with text and symbols not listed in the ordering data.

Insert Labels

By default, a letter height of 4 mm (for a single line of text) or 3 mm (for 2 or 3 lines of text) is used for text inscriptions.

The typeface used is Arial. Other letter heights and typefaces are possible, but must be specified when ordering.

For round insert labels, the maximum possible number of characters per line is:

- 10 characters for one line of text
- 8 characters for 2 lines of text
- 6 characters for 3 lines of text, but 10 characters in the middle line

On square insert labels, 10 characters are possible per line.

Name plates

The following letter heights are used as standard for text inscriptions:

- Label size 12.5 mm × 27 mm: maximum 3 lines with letter height 4 mm (1-line), 3.5 mm (2-line) or 2.5 mm (3-line)
- Label size 27 mm × 27 mm: maximum 5 lines with letter height 4 mm (1- to 5-line)
- Label size 17.5 mm × 28 mm: maximum 3 lines with letter height 4 mm (1- and 2-line) or 3 mm (3-line)

Up to 11 characters per line are possible. The typeface used is Arial. Other letter heights and typefaces are possible, but must be specified when ordering.

Inscription labels for enclosures

A letter height of 4 mm is used as standard for text inscriptions (1 to 3 lines)

Up to 11 characters per line are possible. The typeface used is Arial. Other letter heights and typefaces are possible, but must be specified when ordering.

Ordering notes

Append the following codes to the Order No.:

- Text line(s) in upper/lower case, upper case always for beginning of line (e.g. "Lift off"): **K0Y**
- Text line(s) in upper case (e.g. "LIFT OFF"): **K1Y**
- Text line(s) in lower case (e.g. "lift off"): **K2Y**
- Text line(s) in upper/lower case, all words begin with upper case letters (e.g. "Lift Off"): **K5Y**
- Symbol with number according to ISO 7000 or IEC 60417: **K3Y**
- Any inscription or symbol according to order form supplement: **K9Y**

When ordering, specify the required inscription in plain text in addition to the order number and order code. In the case of special inscriptions with words in languages other than German, give the exact spelling and specify the language.

In the case of multi-line inscriptions, the text must be assigned to the respective line, e.g. "Z1 = Lift, Z2 = Lower". For long words you can also specify the end-of-line division ([see ordering example 1](#)).

Symbols can also be ordered with numbers according to ISO 7000 or IEC 60417 ([see ordering examples 2 and 3](#)).

For special symbols (order code K9Y), a CAD drawing in DXF format should be submitted to sirius-attach.aud@siemens.com

Ordering example 1

A label with 2 lines of text is required:

3SB39 02-1XZ
K1Y
Z1 = LIFT
Z2 = LOWER

Ordering example 2

A label inscribed with symbol No. 5011 according to IEC 60417 is required:

3SB39 02-1XZ
K3Y
Z = 5011 IEC

Ordering example 3

A label inscribed with symbol No. 1118 according to ISO 7000 is required:

3SB39 02-1XZ
K3Y
Z = 1118 ISO

Examples for customized inscription



Two-line inscription in upper/lower case lettering (K0Y)
(Insert labels)



Single-line inscription in upper case lettering (K1Y)
(Name plates)



Three-line inscription in lower case lettering (K2Y)



Symbol number 5011 according to IEC 60417 (K3Y)

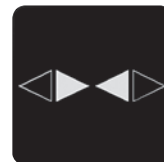

Any symbol according to order form supplement (K9Y)
(Inscription labels for enclosures)

Push Button Units and Indicator Lights

3SB3, Inscriptions, 22 mm

Inscriptions by laser printer

1

2

3

4

5

6

7

8

9

10

Overview

Label inscriptions

Using the *Label Designer* software, which can be downloaded from the Internet, and the inscription labels for laser inscription you can create your own customized labels with a standard laser printer.

The self-adhesive or snap-on labels can be stuck or snapped onto the corresponding label holders (see [Name plates](#)). Round labels are provided for inserting in illuminated push buttons and switches.

The labels are suitable for printing with one to three lines of text or symbols.

For applications with more exacting requirements we recommend factory-printed inscription labels and insert labels (laser-printed or engraved depending on the type).

You can find the *Label Designer* software on the Internet at:

www.siemens.com/sirius-label-designer

Selection and ordering data

Version	Color	DT	Order No.	Price per PU	PU (UNIT, SET, M)	PS
---------	-------	----	-----------	--------------	-------------------	----

Labels for printing

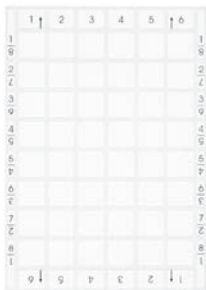

Insert labels for inserting in round illuminated push buttons and illuminated switches	Milky	A	3SB39 01-2AB		100	480 units
Inscription labels 12.5 mm x 27 mm for sticking onto label holder	White	A	3SB39 02-2AA		100	480 units
Inscription labels 27 mm x 27 mm for sticking onto label holder	White	A	3SB39 03-2AA		100	480 units
Inscription labels 17.5 mm x 28 mm for snapping onto label holder	White	A	3SB39 05-2AA		100	720 units
Inscription labels 22 mm x 22 mm for sticking onto enclosure	White	A	3SB39 06-2AA		100	700 units

Push Button Units and Indicator Lights

3SB3, Incriptions, 22 mm

Insert labels

Overview

Push buttons (clear) and illuminated push buttons with a flat button can be fitted with insert labels for identification purposes, but indicator lights cannot.











These insert labels are made of clear, transparent plastic with black inscription; they can be fitted in any 90° angle.

Inscriptions

The inscriptions have upper case initial letters. Graphic symbols, including those not listed in the catalog, are according to ISO 7000 or IEC 60417 (see page 10/72).

The insert labels without inscription are suitable for user marking with permanent pen.

Selection and ordering data

Inscription/Symbol	Symbol No.	DT	Round range		Square range			
			Order No.	Price per PU	Order No.	Price per PU		
Insert labels								
<i>For self-inscription</i>								
	Blank	B	3SB19 01-4AS		B	3SB39 40-4AA		
<i>With inscription</i>								
	On	B	3SB19 01-4EB		B	3SB39 40-4EB		
	Off	B	3SB19 01-4EC		B	3SB39 40-4EC		
	Up	B	3SB19 01-4ED		B	3SB39 40-4ED		
	Down	B	3SB19 01-4EE		B	3SB39 40-4EE		
	Forward	B	3SB19 01-4EF		B	3SB39 40-4EF		
	Reverse	B	3SB19 01-4EG		B	3SB39 40-4EG		
	Right	C	3SB19 01-4EH			—		
	Left	C	3SB19 01-4EJ			—		
	Open	B	3SB19 01-4EP		B	—		
	Close	B	3SB19 01-4EQ			—		
	Fast	B	3SB19 01-4ER			—		
	Slow	B	3SB19 01-4ES			—		
	Running	B	3SB19 01-4EV			3SB39 40-4EV		
	Fault	B	3SB19 01-4EW			3SB39 40-4EW		
	Reset	B	3SB19 01-4EM		B	3SB39 40-4EM		
	Test	B	3SB19 01-4EN			—		
	Start	B	3SB19 01-4EK		B	3SB39 40-4EK		
	Stop	B	3SB19 01-4EL		B	3SB39 40-4EL		
<i>With graphic symbol</i>								
	O (Off)			5008 IEC	B	3SB19 01-4MB	B	3SB39 40-4MB
	I (On)			5007 IEC	B	3SB19 01-4MC	B	3SB39 40-4MC
	II (On)			—	B	3SB19 01-4MD	B	3SB39 40-4MD
	Electric motor			0011 ISO	B	3SB19 01-4PA		3SB39 40-4PA
	Motion in direction of arrow			5022 IEC	B	3SB19 01-4NA	B	3SB39 40-4NA
	Increase, plus			5005 IEC	B	3SB19 01-4NG	B	3SB39 40-4NG
	Decrease, minus			5006 IEC	B	3SB19 01-4MC	B	3SB39 40-4MC
<i>With customized inscription</i>								
	For inscriptions or symbols see "Options"					3SB19 01-4AZ		3SB39 40-4AZ
	• Text line(s) or symbol with No.	B				K0Y, K1Y, K2Y, K3Y or K5Y	B	K0Y, K1Y, K2Y, K3Y or K5Y
	• Any inscription or symbol	B				K9Y	B	K9Y

For customized inscriptions see page 10/72.

Push Button Units and Indicator Lights

3SB3, Inscriptions, 22 mm

Name plates

1
2
3
4
5
6
7
8
9
10

Overview

The name plates consist of a black plastic label holder and an inscription label (black with white print or silver-colored with black print) for sticking or snapping in place. They are not suitable for EMERGENCY-STOP push buttons.

Note mounting dimensions!

Inscriptions

The inscriptions have upper case initial letters. The typeface is Arial. Graphic symbols, including those not listed in the tables, are according to ISO 7000 or IEC 60417 (see page 10/72).

Self-adhesive labels

There are 2 sizes available for the round and square ranges:

- Label holders 30 mm × 45 mm × 7 mm with inscription label 12.5 mm × 27 mm.
- Label holders 30 mm × 60 mm × 7 mm with inscription label 27 mm × 27 mm.

Snap-on labels

The following version is available for the round range:

- Label holders 29.8 mm × 51 mm × 3 mm with inscription label 17.5 mm × 28 mm (inscription area: 17.5 mm × 27 mm)

Selection and ordering data

Inscriptions	DT	Black Order No.	DT	Silver-colored Order No.
Inscription labels, self-adhesive, 12.5 mm × 27 mm				
<i>For self-inscription</i>				
Blank	▶	3SB39 02-1AA	B	3SB19 01-2AA
<i>With inscription</i>				
On	B	3SB39 02-1EB	B	3SB19 01-2EB
Off	B	3SB39 02-1EC	B	3SB19 01-2EC
Up	B	3SB39 02-1ED	B	3SB19 01-2ED
Down	B	3SB39 02-1EE	B	3SB19 01-2EE
Emerg. Stop		3SB39 02-1AU		
Hand O Auto		3SB39 02-1BE		
Jog		3SB39 02-1BG		
Man O Auto		3SB39 02-1ET		
Power Off		3SB39 02-1BH		
Power On		3SB39 02-1BJ		
Reset		3SB39 02-1EM		
Run		3SB39 02-1EX		
Forward	B	3SB39 02-1EF		
Reverse	B	3SB39 02-1EG		
Right	B	3SB39 02-1EH	B	3SB19 01-2EH
Left	B	3SB39 02-1EJ	B	3SB19 01-2EJ
Open	B	3SB39 02-1EP	B	3SB19 01-2EP
Close	B	3SB39 02-1EQ	B	3SB19 01-2EQ
Fast		—	B	3SB19 01-2ER
Slow		—	B	3SB19 01-2ES
Stop	B	3SB39 02-1EK	B	3SB19 01-2EK
Start	B	3SB39 02-1EL	B	3SB19 01-2EL
Test	B	3SB39 02-1EN	B	3SB19 01-2EN
Running		—	B	3SB19 01-2EV
Fault	B	3SB39 02-1EW	B	3SB19 01-2EW
Reset		—	B	3SB19 01-2EM
Stop Start	B	3SB39 02-1BC	B	3SB19 01-2BC
Hand Auto	B	3SB39 02-1BA	B	3SB19 01-2BA
Man Auto	B	3SB39 02-1EU	B	3SB19 01-2EU
Hand O Auto		—	B	3SB19 01-2BE
Man O Auto		—	B	3SB19 01-2ET
Off On		3SB39 02-1EA		

For label holders see page 10/78.

For customized inscriptions see page 10/72..

Push Button Units and Indicator Lights

3SB3, Incriptions, 22 mm

Name plates

Incriptions	DT	Black	DT	Silver-colored
		Order No.		Order No.

Inscription labels, self-adhesive, 12.5 mm x 27 mm



With graphic symbol

O
I
II
III
O I
I O II
I O 2
1 2

B	3SB39 02-1MB	B	3SB19 01-2MB
B	3SB39 02-1MC	B	3SB19 01-2MC
	—	C	3SB19 01-2MD
	—	B	3SB19 01-2ME
B	3SB39 02-1MF	B	3SB19 01-2MF
B	3SB39 02-1MG	B	3SB19 01-2MG
	—	B	3SB19 01-2MK
B	3SB39 02-1ML		—
B	3SB39 02-1NJ	B	3SB19 01-2NA
B	3SB39 02-1NA	B	3SB19 01-2NJ



With customized inscription

For inscriptions or symbols see "Options"

- Text line(s)
- Text line(s) or symbol with No.
- Any inscription or symbol

B	3SB39 02-1XZ	B	3SB19 01-2XZ
B	K0Y	B	K0Y
B	K1Y, K2Y, K3Y or K5Y	B	K1Y, K2Y, K3Y or K5Y
B	K9Y	B	K9Y

Incriptions	DT	Black	DT	Silver-colored
		Order No.		Order No.

Inscription labels, self-adhesive, 27 mm x 27 mm



For self-inscription

Blank

B	3SB39 03-1AA	B	3SB19 06-2AA
---	--------------	---	--------------

With inscription

On
Off
Start
Emerg. Stop
Hand O Auto
Jog
Man O Auto
Power Off
Power On
Reset
Run
Forward
Reverse
Right
Left
Up
Down
Open
Close
Test
Stop
Man Auto
Off On

B	3SB39 03-1EB		—
B	3SB39 03-1EC		—
B	3SB39 03-1EL		—
B	3SB39 03-1AU		—
B	3SB39 03-1BE		—
B	3SB39 03-1BG		—
B	3SB39 03-1ET		—
B	3SB39 03-1BH		—
B	3SB39 03-1BJ		—
B	3SB39 03-1EM		—
B	3SB39 03-1EX		—
B	3SB39 03-1EF		—
B	3SB39 03-1EG		—
B	3SB39 03-1EH		—
B	3SB39 03-1EJ		—
B	3SB39 03-1ED		—
B	3SB39 03-1EE		—
B	3SB39 03-1EP		—
B	3SB39 03-1EQ		—
B	3SB39 03-1EN		—
B	3SB39 03-1EK		—
B	3SB39 03-1EU		—
B	3SB39 03-1EA		—

Stop Start
Hand Auto

B	3SB39 03-1BC		—
B	3SB39 03-1BA		—



With graphic symbol

O
O I

B	3SB39 03-1MB		—
B	3SB39 03-1MF		—
B	3SB39 03-1NA		—



With customized inscription

For inscriptions or symbols see "Options"

- Text line(s)
- Text line(s) or symbol with No.
- Any inscription or symbol

B	3SB39 03-1XZ	B	3SB19 06-2XZ
B	K0Y	B	K0Y
B	K1Y, K2Y, K3Y or K5Y	B	K1Y, K2Y, K3Y or K5Y
B	K9Y	B	K9Y

For label holders [see page 10/78](#).

For customized inscriptions [see page 10/72](#).

Push Button Units and Indicator Lights







3SB3, Inscriptions, 22 mm

Name plates

1
2
3
4
5
6
7
8
9
10

Inscriptions	DT	Black	DT	Silver-colored
		Order No.		Order No.

Inscription labels, for snapping on, 17.5 mm x 28 mm

	For self-inscription				
	Blank	B	3SB39 05-1AA	B	3SB19 04-2AA
	With inscription				
	On	B	3SB39 05-1EB	B	3SB19 04-2EB
	Off	B	3SB39 05-1EC	B	3SB19 04-2EC
	Up	B	3SB39 05-1ED		—
	Down	B	3SB39 05-1EE		—
	Forward	B	3SB39 05-1EF	B	—
	Reverse	B	3SB39 05-1EG	B	3SB19 04-2EG
	Right	B	3SB39 05-1EH		—
	Left	B	3SB39 05-1EJ		—
	Open	B	3SB39 05-1EP		—
	Close	B	3SB39 05-1EQ		—
	Stop	B	3SB39 05-1EK	B	3SB19 04-2EK
	Start	B	3SB39 05-1EL	B	3SB19 04-2EL
	Test		—	B	3SB19 04-2EN
	Running	B	3SB39 05-1EV		—
	Fault	B	3SB39 05-1EW	B	3SB19 04-2EW
	Reset		—	B	3SB19 04-2EM
	Stop Start	B	3SB39 05-1BC	B	3SB19 04-2BC
	Hand Auto	B	3SB39 05-1BA	B	3SB19 04-2BA
	Man Auto	B	3SB39 05-1EU	C	3SB19 04-2EU
	Man O Auto		—	B	3SB19 04-2ET
	With graphic symbol				
	O	B	3SB39 05-1MB	B	3SB19 04-2MB
	I	B	3SB39 05-1MC	B	3SB19 04-2MC
	O I	B	3SB39 05-1MF	B	3SB19 04-2MF
	I O II		—	B	3SB19 04-2MG
	1 O 2		—	B	3SB19 04-2MK
		B	3SB39 05-1NA	B	3SB19 04-2NA
		B	3SB39 05-1NJ	B	3SB19 04-2NJ
	With customized inscription				
	For inscriptions or symbols see "Options"		3SB39 05-1XZ		3SB19 04-2XZ
	• Text line(s)	B	K0Y	B	K0Y
	• Text line(s) or symbol with No.	B	K1Y, K2Y, K3Y or K5Y	B	K1Y, K2Y, K3Y or K5Y
	• Any inscription or symbol	B	K9Y	B	K9Y



For label holders [see page 10/78](#).

For customized inscriptions [see page 10/72](#).

Push Button Units and Indicator Lights

3SB3, Incriptions, 22 mm

Name plates

Version	DT	Black	PU (UNIT, SET, M)	PS
		Order No.		
Label holders for inscription labels 12.5 mm × 27 mm				
	For round range, flat	B	3SB39 22-0AV	100 10 units
	For potentiometer drives 3SB10 00-7CH07 ¹⁾	B	3SB39 22-0AS	1 1 unit
	For square range, flat	B	3SB39 42-0AX	100 5 units
Label holders for inscription labels 27 mm × 27 mm				
	For round range, flat	B	3SB39 23-0AV	100 10 units
	For round range, raised	C	3SB39 23-0AX	1 10 units
	For potentiometer drives, flat	B	3SB39 23-0AS	1 1 unit
	For square range, flat	B	3SB39 43-0AX	100 1 unit
Label holders for inscription labels 17.5 mm × 28 mm				
	For round design	▶	3SB39 25-0AV	100 10 units

¹⁾ This label holder can also be used for push buttons with dust covers if the front panel thickness of 3 mm is not exceeded.











Push Button Units and Indicator Lights

3SB3, Accessories and spare parts, 22 mm

Buttons and lenses

1
2
3
4
5
6
7
8
9
10

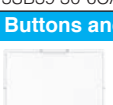
Selection and ordering data

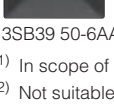
Version	Color	DT	Order No.	PU (UNIT, SET, M)	PS						
Buttons and lenses for round version¹⁾											
 3SB39 30-0CA6	Buttons, flat for round illuminated push buttons and illuminated switches, plastic version	Red Yellow Green Blue White Clear	B B B B B B	3SB39 30-0CA2 3SB39 30-0CA3 3SB39 30-0CA4 3SB39 30-0CA5 3SB39 30-0CA6 3SB39 30-0CA7	1 1 1 1 1 1	10 units 10 units 10 units 10 units 10 units 10 units					
	 3SB39 30-0EA3	Buttons, flat for round push buttons and switches, metal version	Black Red Yellow Green Blue White Clear	B B B B B B B	3SB39 30-0EA1 3SB39 30-0EA2 3SB39 30-0EA3 3SB39 30-0EA4 3SB39 30-0EA5 3SB39 30-0EA6 3SB39 30-0EA7	1 1 1 1 1 1 1	10 units 10 units 10 units 10 units 10 units 10 units 10 units				
		 3SB39 30-0DA4	Buttons, raised for round illuminated push buttons and illuminated switches, plastic version	Red Green Clear	B B B	3SB39 30-0DA2 3SB39 30-0DA4 3SB39 30-0DA7	1 1 1	10 units 10 units 10 units			
			 3SB39 30-0FA4	Buttons, raised for round push buttons and switches, metal version	Black Red Yellow Green Blue White Clear	D C C C C C C	3SB39 30-0FA1 3SB39 30-0FA2 3SB39 30-0FA3 3SB39 30-0FA4 3SB39 30-0FA5 3SB39 30-0FA6 3SB39 30-0FA7	1 1 1 1 1 1 1	10 units 10 units 10 units 10 units 10 units 10 units 10 units		
				 3SB39 30-0GA3	Buttons, flat for round illuminated push buttons and illuminated switches, metal version	Amber Red Yellow Green Blue White Clear	B B B B B B B	3SB39 30-0GA0 3SB39 30-0GA2 3SB39 30-0GA3 3SB39 30-0GA4 3SB39 30-0GA5 3SB39 30-0GA6 3SB39 30-0GA7	1 1 1 1 1 1 1	10 units 10 units 10 units 10 units 10 units 10 units 10 units	
		 3SB39 30-0HA4			Buttons, flat, solvent-resistant²⁾ for round illuminated push buttons and switches, metal version	Red Yellow Green Blue White Clear	B B B B B B	3SB39 30-0GA20-0PA0 3SB39 30-0GA30-0PA0 3SB39 30-0GA40-0PA0 3SB39 30-0GA50-0PA0 3SB39 30-0GA60-0PA0 3SB39 30-0GA70-0PA0	1 1 1 1 1 1	10 units 10 units 10 units 10 units 10 units 10 units	
					 3SB39 30-0BA3	Buttons, raised for round illuminated push buttons and illuminated switches, metal version	Amber Red Yellow Green Blue White Clear	C C C C C C C	3SB39 30-0HA0 3SB39 30-0HA2 3SB39 30-0HA3 3SB39 30-0HA4 3SB39 30-0HA5 3SB39 30-0HA6 3SB39 30-0HA7	1 1 1 1 1 1 1	10 units 10 units 10 units 10 units 10 units 10 units 10 units
 3SB39 30-6CA3						Lenses, smooth For round indicator lights, plastic and metal version	Amber Red Yellow Green Blue White Clear	C B B B B B B	3SB39 30-6BA0 3SB39 30-6BA2 3SB39 30-6BA3 3SB39 30-6BA4 3SB39 30-6BA5 3SB39 30-6BA6 3SB39 30-6BA7	1 1 1 1 1 1 1	10 units 10 units 10 units 10 units 10 units 10 units 10 units
	 3SB39 50-0CA6					Lenses with concentric rings For round indicator lights, plastic and metal version	Amber Red Yellow Green Blue White Clear	B B B B B B B	3SB39 30-6CA0 3SB39 30-6CA2 3SB39 30-6CA3 3SB39 30-6CA4 3SB39 30-6CA5 3SB39 30-6CA6 3SB39 30-6CA7	1 1 1 1 1 1 1	10 units 10 units 10 units 10 units 10 units 10 units 10 units
						 3SB39 50-6AA2	Buttons, flat For square illuminated push buttons and illuminated switches, plastic version	Red Yellow Green Blue White Clear	B B B B B B	3SB39 50-0CA2 3SB39 50-0CA3 3SB39 50-0CA4 3SB39 50-0CA5 3SB39 50-0CA6 3SB39 50-0CA7	1 1 1 1 1 1
		 3SB39 50-6AA2	Lenses, smooth For square indicator lights, plastic version				Red Yellow Green Blue White Clear	B B B B B B	3SB39 50-6AA2 3SB39 50-6AA3 3SB39 50-6AA4 3SB39 50-6AA5 3SB39 50-6AA6 3SB39 50-6AA7	1 1 1 1 1 1	10 units 10 units 10 units 10 units 10 units 10 units

¹⁾ In scope of supply of push buttons or indicator lights.



²⁾ Not suitable for laser inscription.

Push Button Units and Indicator Lights

3SB3, Accessories and spare parts, 22 mm

Lamps, acoustic signal transformers and keys

Selection and ordering data

Version	Rated voltage	Color	DT	Order No.	PU (UNIT, SET, M)	PS
V						
Lamps, BA 9s bases¹⁾						
 3SB19 02-0AY	Incandescent lamps 1.2 W , length up to 28 mm, max. bulb diameter 10 mm	24 AC/DC	Clear	A	3SB19 02-0AY	1 10 units
	Incandescent lamps 2 W , length up to 28 mm, max. bulb diameter 10 mm	6 AC/DC	Clear	A	52AABN	1 1 units
		12 AC/DC		A	52AACN	1 1 units
		24 AC/DC		A	52AADN1	1 1 units
		30 AC/DC		B	3SB19 02-2AF	1 10 units
48 AC/DC			B	3SB19 02-1AP	1 10 units	
60 AC/DC		A	3SR94 24	1 10 units		
Incandescent lamps 2.6 W , length 28 mm, bulb diameter 10 mm	110 ... 130 AC/DC ²⁾	Clear	▶	3SX1 731	1 10 units	
Incandescent lamps 3 W , length 28 mm, bulb diameter 10 mm	120V #120 MB	Clear	▶	52AAENC	1 1 units	
Multi-incandescent lamps 1.2 W , endurance 25 000 h, high resistance to vibration	24 AC/DC		B	3SB19 02-2BU	1 10 units	
 3SB39 01-1PA	LED lamps, super-bright Length up to 28 mm, max. bulb diameter 10 mm, max. operational current 15 mA	24 V AC/DC	Red	▶	52AED2	1 1 units
			Green	B	52AED3	1 1 units
			Yellow	▶	52AED4	1 1 units
			White	B	52AEDB	1 1 units
			Blue	▶	52AED5	1 1 units
	48 AC/DC	Red	B	3SB39 01-1CC	1 10 units	
		Yellow	B	3SB39 01-1BC	1 10 units	
		Green	B	3SB39 01-1DC	1 10 units	
		Blue	B	3SB39 01-1PC	1 10 units	
		White	B	3SB39 01-1QC	1 10 units	
	120 AC/DC	Red	B	52AEE2	1 1 units	
		Green	B	52AEE3	1 1 units	
		Yellow	B	52AEE4	1 1 units	
		White	B	52AEEB	1 1 units	
		Blue	B	52AEE5	1 1 units	
	230 AC, 110 ... 160 DC, if X1 at "+"	Red	B	3SB39 01-1CF	1 10 units	
		Yellow	B	3SB39 01-1BF	1 10 units	
		Green	B	3SB39 01-1DF	1 10 units	
		Blue	B	3SB39 01-1PF	1 10 units	
		White	B	3SB39 01-1QF	1 10 units	
230 AC/DC	Red	B	3SB39 01-1CG	1 10 units		
	Yellow	B	3SB39 01-1BG	1 10 units		
	Green	B	3SB39 01-1DG	1 10 units		
	Blue	B	3SB39 01-1PG	1 10 units		
	White	B	3SB39 01-1QG	1 10 units		
LED lamps Length up to 28 mm, max. bulb diameter 10 mm, max. operational current 15 mA	22 ... 32 DC	Red	D	3SB19 02-4AJ	1 10 units	
		Yellow	D	3SB19 02-4BJ	1 10 units	
		Green	D	3SB19 02-4CJ	1 10 units	
LED lamps, flashing (1.4 Hz) , length up to 28 mm, bulb diameter 10 mm, operational current 24 ... 29 mA	24 DC	Red	B	3SB19 02-4LC	1 10 units	
		Yellow	C	3SB19 02-4MC	1 10 units	
		Green	C	3SB19 02-4NC	1 10 units	
Glow lamps³⁾ length 28 mm, bulb diameter 10 mm, operational current approx. 1.8 mA	110 AC	Clear	A	3SX1 703	1 10 units	
	220 AC	Clear	A	3SX1 701	1 10 units	
	220 AC	Green	C	3SX1 702	1 10 units	
Lamp extractors For lamps with BA 9s base			▶	3SB19 02-2AD	1 1 unit	

¹⁾ Essential accessories when using lamp holders with BA 9s base and delivery without lamp.

²⁾ Also for 230 V when used with a 3SB34 00-1C voltage reducer.







³⁾ Due to the inherent orange color of glow lamps and their lower luminance level compared to incandescent lamps, it is recommended that they should only be used with clear or red screw lenses and in areas where ambient light levels are not very high.

Push Button Units and Indicator Lights

3SB3, Accessories and spare parts, 22 mm

Lamps, acoustic signal transformers and keys

1
2
3
4
5
6
7
8
9
10

Version	Rated voltage	Color	DT	Order No.	PU (UNIT, SET, M)	PS
Lamps, Wedge bases¹⁾						
 3SB29 08-1AE	Wedge base W2 x 4.6 d, 1.0 W	Clear	C	3SB29 08-1AA	100	10 units
			B	3SB29 08-1AB	100	10 units
			▶	3SB29 08-1AC	100	10 units
			A	3SB29 08-1AD	100	10 units
			B	3SB29 08-1AE	1	10 units
			B	3SB29 08-1AF	1	10 units
 3SB39 01-1SB	Wedge base W2 x 4.6 d, operational current 10 mA	Red Yellow Green White Blue	B	3SB39 01-1SB	1	10 units
			B	3SB39 01-1RB	1	10 units
			B	3SB39 01-1TB	1	10 units
			B	3SB39 01-1UB	1	10 units
			B	3SB29 08-1BD	1	10 units
			B	3SB29 08-1BD	1	10 units
 3SB39 01-1VE	Wedge base W2 x 4.6 d, operational current 10 mA	Red Yellow Green White Blue	B	3SB39 01-1SE	1	10 units
			B	3SB39 01-1RE	1	10 units
			B	3SB39 01-1TE	1	10 units
			B	3SB39 01-1UE	1	10 units
			D	3SB39 01-1VE	1	10 units
			▶	3SB29 08-2AB	1	1 unit
 3SB29 08-2AB	for lamps with bases W2x 4.6 d			3SB29 08-2AB	1	1 unit
 3SB19 02-1AU	For fitting a lamp with a wedge base socket into a BA 9s lamp holder			3SB19 02-1AU	1	1 unit
Acoustic signal transformers, BA 9s base						
 3SB19 02-2BN	Acoustic signal transformers for acoustic signaling devices ²⁾ operational current 25 mA, 0.6 W, sound pressure 80 dB/10 cm	24 ... 28 DC		B	3SB19 02-2BN	1 1 unit

¹⁾ Can be used with lamp adapters in lamp holders with BA 9s base.

²⁾ For increased protection, the IP65 acoustic signaling device (complete unit) can be used.

Version	Lock	Color	DT	Order No.	PU (UNIT, SET, M)	PS
Manufacturer	Lock No.					
Keys for actuators¹⁾						
 3SY1 054	RONIS	SB 30	—	B	3SB39 10-4A	1 1 unit
	BKS	S1	—	A	3SY1 066	1 1 unit
	CES	LSG 1	—	B	3SB19 10-2F	1 1 unit
		SSG 10	—	B	3SY1 054	1 1 unit
		SSP 9	—	A	3SY1 052	1 1 unit
	O.M.R.	73038	Light blue	C	3SB19 10-2L	1 1 unit
		73037	Red	B	3SB19 10-2M	1 1 unit
		73034	Black	B	3SB19 10-2N	1 1 unit
		73033	Yellow	D	3SB19 10-2P	1 1 unit









¹⁾ Included in scope of supply of the key-operated switches and the EMERGENCY-STOP mushroom push buttons with key-operated switch. Also available with special lock. Supplement Order No. with "-Z" and quote the required lock in plain text. Additional price on request. This does not include locks for VW and main and general locking systems.

Push Button Units and Indicator Lights

3SB3, Accessories and spare parts, 22 mm

Protective covers

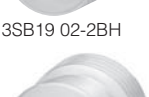
Selection and ordering data

Version	Use	Color	DT	Order No.	PU (UNIT, SET, M)	PS	
Protective caps¹⁾, degree of protection IP67							
<i>Material: elastolan</i>							
	Protective caps For round version	Flat button (plastic)	Clear	B	3SB39 21-0AJ	1	1 unit
		Flat button (metal), raised button (plastic)	Clear	B	3SB39 21-0AM	1	1 unit
		• PVC Raised button (metal)	Clear	C	3SB19 02-2AN	1	1 unit
	Protective caps For square version	Flat button (plastic)	Clear	B	3SB39 41-0AJ	1	1 unit
<i>Material: silicone</i>							
	Protective caps For round version	Flat button (plastic)	Clear	B	3SB39 21-0AH	1	1 unit
		Flat button (metal), raised button (plastic)	Clear	B	3SB19 02-0AK	1	1 unit
		Raised button (metal)	Clear	B	3SB19 02-0AN	1	1 unit
	Protective caps For round version	Selector switch (plastic and metal, normal handle)	Clear	B	3SB39 21-0BA	1	1 unit
	Protective caps For round version	Mushroom push-pull button, Ø 40 mm (plastic and metal)	Clear	B	3SB19 02-2BH	1	1 unit
		EMERGENCY-STOP mushroom pushbutton, Ø 40 mm (plastic and metal)	Clear	B	3SB39 21-0BU	1	1 unit
	Protective caps For square version	Flat button (plastic)	Clear	B	3SB39 41-0AH	1	1 unit

¹⁾ Protective caps are not suitable for use with 3SB38 plastic enclosures.
With 3SB38 metal enclosures, protective caps can only be used with
3SB34 00 single-pole contact blocks for front plate mounting.
Not to be used with label holder.

Push Button Units and Indicator Lights

3SB3, Accessories and spare parts, 22 mm

Protective covers

1

2

3

4

5

6

7

8

9

10

Version	Use	Color	DT	Order No.	PU (UNIT, SET, M)	PS
---------	-----	-------	----	-----------	-------------------------	----

Other protective caps¹⁾

	Sealable caps	Flat button (plastic)	Black	B	3SB19 02-0AL	1	1 unit
	For round version	Flat button (metal), raised button (plastic)	Clear	B	3SB19 02-2AR	1	1 unit

3SB19 02-0AL



3SB19 02-2AR



3SB39 21-0BT

Dust covers	BKS, CES, O.M.R. key-operated switch	Clear	B	3SB39 21-0BT	1	1 unit
--------------------	--------------------------------------	-------	---	---------------------	---	--------

For use in dusty environments

Protective collars for front plates

	Protective collars for EMERGENCY-STOP²⁾	EMERGENCY-STOP mushroom push button without key-operated switch	Yellow	▶	3SB39 21-0AK	1	1 unit
		EMERGENCY-STOP mushroom pushbutton with key-operated switch	Gray	C	3SB39 21-0AP	1	1 unit
	For round version	EMERGENCY-STOP mushroom pushbutton with key-operated switch	Yellow	B	3SB39 21-0AX	1	1 unit

3SB39 21-0AX



3SB39 21-0CG

Protective collars for EMERGENCY-STOP for 5 padlocks²⁾	3SB3...-1AA20 EMERGENCY-STOP mushroom push button	Yellow	▶	3SB39 21-0CG	1	1 unit
--	---	--------	---	---------------------	---	--------

For round version



3SB39 21-0AS

Sun collars	Illuminated push buttons	Black	B	3SB39 21-0AS	1	1 unit
--------------------	--------------------------	-------	---	---------------------	---	--------

For round version

Blanking plugs for spare command points for front plates

	Blanking plugs	Plastic version	Black	▶	3SB39 21-0AA	1	10 units
---	-----------------------	-----------------	-------	---	---------------------	---	----------

For round version

3SB39 21-0AA



3SB39 41-0AA

Blanking plugs	Plastic version	Black	B	3SB39 41-0AA	1	1 unit
-----------------------	-----------------	-------	---	---------------------	---	--------

For square version



3SB19 02-0AQ

Blanking plugs (plastic) for round version	Metal version	Aluminized	B	3SB19 02-0AQ	1	10 units
---	---------------	------------	---	---------------------	---	----------

¹⁾ Not suitable for mounting in 3SB38 enclosures.
Not to be used with label holder.









²⁾ The protective collar must only be used to protect against inadvertent actuating and must be fitted to allow unimpeded actuation of the EMERGENCY-STOP mushroom pushbutton.

Push Button Units and Indicator Lights

3SB3, Accessories and spare parts, 22 mm

Miscellaneous accessories

Selection and ordering data

Version	Use	Inscriptions	DT	Order No.	PU (UNIT, SET, M)	PS	
Yellow name plates for EMERGENCY-STOP							
<i>For use on front plates</i>							
	Name plates, round Self-adhesive, external diameter 60 mm, internal diameter 23 mm	EMERGENCY-STOP mushroom push button (round version)	Blank	B	3SB39 21-0DY	1 1 unit	
3SB39 21-0AC	Name plates, round Self-adhesive, external diameter 80 mm, internal diameter 23 mm	EMERGENCY-STOP mushroom push button (round version)	Blank	B	3SB39 21-0AB	1 1 unit	
	Name plates, round Self-adhesive, external diameter 80 mm, cutout 26 mm x 26 mm	EMERGENCY-STOP mushroom push buttons (square version)	EMERGENCY STOP	B	3SB39 21-0AD	1 1 unit	
3SB39 21-0BW	Name plates, round Self-adhesive, external diameter 80 mm, cutout 26 mm x 26 mm	EMERGENCY-STOP mushroom push buttons (square version)	Blank	B	3SB39 41-0AB	1 1 unit	
	Name plates, round 1 mm thick, external diameter 75 mm, internal diameter 22.5 mm	EMERGENCY-STOP mushroom push button (round version)	Blank	B	3SB19 02-2BA	1 1 unit	
3SB39 21-0DA	Name plates, round Self-adhesive, external diameter 60 mm, internal diameter 23 mm ¹⁾	EMERGENCY-STOP mushroom push button (round version)	Blank	B	3SB39 21-0DA	1 1 unit	
	Illuminated, suitable as signaling device for EMERGENCY-STOP, with plug-in connection for 24 V AC/DC ²⁾	EMERGENCY STOP	EMERGENCY STOP	B	3SB39 21-0DD	1 1 unit	
Inscription labels							
	Inscription labels For supporting dust resistance	Contact blocks		B	3SB39 01-0CH	100 10 units	
3SB39 01-0CH	Unit labeling plates	Contact blocks		B	3TX4 210-0H	100 100 units	
							
3TX4 210-0H	Lockouts						
	Locking cover	Prevents access to pushbuttons, knob type selector switches and will work with both metal and plastic devices			3SB39 21-0BS	1 1 unit	
3SB3921-0BS	Lockout	for metal flush pushbutton for metal extended pushbutton for metal mushroom cap (40 mm) pushbutton			3SB39 21-0BG 3SB39 21-0BH 3SB39 21-0BJ	1 1 unit 1 1 unit 1 1 unit	
							
3SB3921-0BG	2 Position Selector Switch Lockouts³⁾	Lock in left position Lock in right position			3SB39 21-0BK 3SB39 21-0BL	1 1 unit 1 1 unit	
							
3SB3921-0BK	3 Position Selector Switch Lockouts³⁾	Lock in left position Lock in center position Lock in right position Lock out -left position only Lock out -right position only			3SB39 21-0BM 3SB39 21-0BN 3SB39 21-0BP 3SB39 21-0BQ 3SB39 21-0BR	1 1 unit 1 1 unit 1 1 unit 1 1 unit 1 1 unit	
							
3SB3921-0BN							

1) For front panel thickness of max. 4 mm.

2) The illuminated label can also be operated through the AS-Interface F adapter (see page 10/97).

3) For metal devices only.

Push Button Units and Indicator Lights

3SB3, Accessories and spare parts, 22 mm

Miscellaneous accessories

1
2
3
4
5
6
7
8
9
10

Version	Use	DT	Order No.	PU (UNIT, SET, M)	PS
Holders and pressure plates					
 3SB39 01-0AB	Holders For snapping on 3 blocks ¹⁾	▶	3SB39 01-0AB	100	20 units
 3SB39 01-0AC	Holders with pressure plate For actuating the central contact block of 3 contact blocks ²⁾	▶	3SB39 01-0AC	100	10 units
 3SB39 01-0AW	Pressure plates For actuating the central contact block of 3 contact blocks ²⁾	B	3SB39 01-0AW	100	10 units
Holders for commanding and signaling elements³⁾					
 3SB39 31-0AA	Holders For plastic version, round	▶	3SB39 31-0AA	1	10 units
 3SB39 51-0AA	Holders For plastic version, square	B	3SB39 51-0AA	1	1 unit
 3SB39 31-0AC	Holders For metal version, round	▶	3SB39 31-0AC	1	10 units
 3SB39 21-0BD	Grounding screws For grounding metal actuators for fitting in front plates made of non-conducting materials	B	3SB39 21-0BD	100	50 units
	Bolt for enclosure Ring nut wrench		3SB39 31-0AB		
Guards					
 3SB3921-0BE	Pushbutton Guard		3SB39 21-0BE	1	1 unit
 3SB3921-0BF	Guard		3SB39 21-0BF	1	1 unit







1) The holder for illuminated commanding devices is included in the scope of supply.
2) The pressure plates can be removed one by one to meet individual requirements.

3) The matching holder for actuators and indicators is included in the scope of supply (exception: Order with order code "B01").

Push Button Units and Indicator Lights

3SB3, Accessories and spare parts, 22 mm

Miscellaneous accessories

Version	Use	Color	DT	Order No.	PU (UNIT, SET, M)	PS
Tools						
	Blanking tools 26 mm × 26 mm, for square version		B	3SB39 41-0AF	1	1 unit
3SB39 41-0AF						
	Hole drilling templates for 30 mm × 30 mm grid, horizontal, for round and square versions		C	3SB19 02-2BG	1	1 unit
3SB19 02-2BG						
	Mounting tools For buttons and lenses, metal version		B	3SB39 21-0BC	1	1 unit
3SB39 21-0BC						
	Mounting tools For potentiometer drives and for push buttons with extended stroke		C	3SX1 707	1	1 unit
3SX1 707						
	Dismantling tools For contact blocks and lamp holders	Blocks with screw terminals	B	3SB39 01-0CB	1	1 unit
3SB39 01-0CB						
	Dismantling tools For contact blocks and lamp holders	With spring-type terminals	C	3SB39 01-0CG	1	1 unit
Various accessories						
	Single frames For square design of the round version	Black	C	3SB39 21-0AU	1	1 unit
3SB39 21-0AU						
	Adapter parts Adapters for 30.5 mm mounting hole, comprising a metal disk with an adhe- sive layer on one side, degree of protection IP65	As thrust ring for a thin molded- plastic front plate	B	3SB39 21-0AE	1	1 unit
3SB39 21-0AE						
	Printed circuit board holders For mounting the command devices on the printed circuit board (screw is included in the scope of supply)	Contact blocks and lamp hold- ers for solder connection	B	3SB39 01-0AA	100	10 units
3SB39 01-0AA						
	Extension plungers For compensation of the distance between a push button and the unlatch- ing button of an overload relay	Push buttons with extended stroke	A	3SX1 335	1	1 unit
3SX1 335						

Overview



Enclosures with standard and customized equipment

Enclosed push buttons and indicator lights are used as hand operated control devices for separately allocated control units and cabinets.

Enclosures with handle are available for suspension (e.g. for crane control units).

The enclosed push buttons and indicator lights are available with conventional controls as well as for connection to the AS-Interface bus system.

The following versions are available:

- Enclosures with standard fittings with 1 to 3 command points
- Enclosures with customized equipment with 1 to 6 command points
- Empty enclosures (individual parts must be ordered separately)

Customer-specific enclosures

On request enclosures with more than 6 command points can also be supplied with AS-Interface connection.

Use the configurator for selection.

For AS-Interface enclosures [see page 10/96](#).

Enclosures with standard fittings

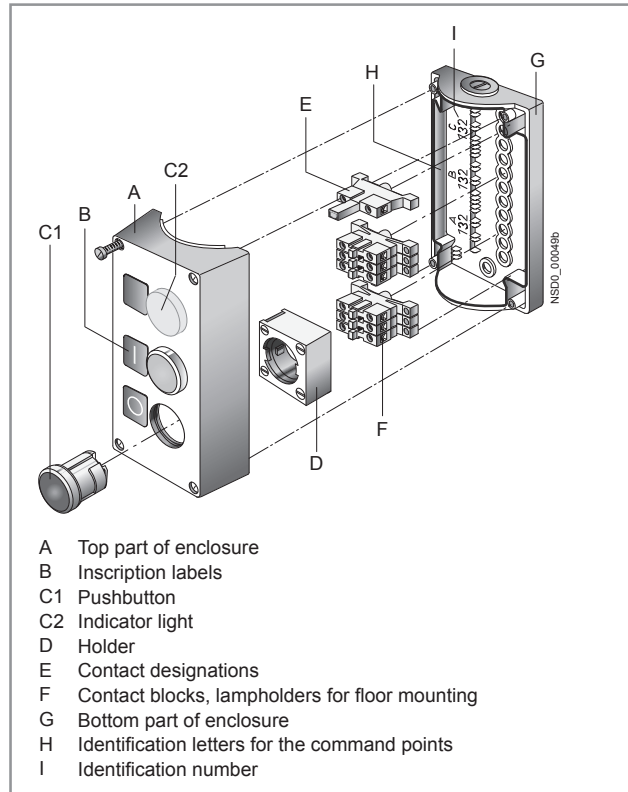

Standards

IEC 60947-5-1, EN 60947-5-1

Application

The devices are climate-proof (KTW 24) according to EN ISO 6270-2 and suitable for stationary use (weather-protected) and for use in marine applications.

Technical specifications

Type	3SB38 0.-0, 3SB38 0.-1	3SB38 0.-2, 3SB38 0.-3
Enclosures		
Enclosure material	Plastic	Metal
Actuators and indicators	Plastic, round	Metal, round
Degree of protection acc. to IEC 60529	IP65	IP67 and NEMA Type 4
Climatic withstand capability according to EN ISO 6270-2	KTW 24	
Shock resistance according to IEC 60068-2-27 for half-sine shock type, 11 ms shock duration		
• Devices without incandescent lamp	≤ 50 g	
• Devices with incandescent lamp	≤ 30 g	
Vibration resistance acc. to IEC 60068-2-6		
• Acceleration at frequency 20 ... 200 Hz	5 g	

Push Button Units and Indicator Lights

3SB3, Enclosures, 22 mm

Enclosures with standard fittings

Overview

Enclosures with standard fittings are available with:

- 1 to 3 command points
- Operational voltage up to 400 V
- Vertical mounting type
- Plastic enclosures are equipped with plastic actuators and indicators, metal enclosures are equipped with metal actuators and indicators
- Contact blocks and lamp holders for base mounting (are snapped into the enclosure base); screw terminals (box terminals) as standard; some versions also with spring-type terminals (Order No. ends with -0CC0)



Color of enclosure cover:

- Gray, RAL 7035
- Yellow, RAL 1004

Color of enclosure base:









- Black, RAL 9005

Selection and ordering data

Equipment	Contact block function	Number of command points	DT	Screw terminals	PU (UNIT, SET, M)	PS
						
						
Order No.						

Plastic enclosures with standard fittings

Cable entry top and bottom each 1 x M20

	A = Pushbutton green, label "I"	1 NO	1	B	3SB38 01-0DA3	1	1 unit
	A = Pushbutton red, label "O"	1 NC	1	B	3SB38 01-0DB3	1	1 unit
	A = Pushbutton white, label "I"	1 NO	1	B	3SB38 01-0DD3	1	1 unit
	A = Pushbutton black, label "O"	1 NC	1	B	3SB38 01-0DE3	1	1 unit
	A = EMERGENCY-STOP mushroom pushbutton, Ø 40 mm, with positive latching according to ISO 13850 and rotate-to-unlatch mechanism						
	• With yellow top part, without protective collar	1 NC 	1	B	3SB38 01-0DG3	1	1 unit
		2 NC 	1	B	3SB38 01-0EG3	1	1 unit
	• With yellow top part, with protective collar ¹⁾	1 NC 	1	B	3SB38 01-0DF3	1	1 unit
		2 NC 	1	B	3SB38 01-0EF3	1	1 unit
	B = Pushbutton green, label "I"	1 NO,	2	B	3SB38 02-0DA3	1	1 unit
	A = Pushbutton red, label "O"	1 NC					
	B = Pushbutton white, label "I"	1 NO,	2	B	3SB38 02-0DB3	1	1 unit
	A = Pushbutton black, label "O"	1 NC					
	C = Indicator light clear, label without inscription,	BA 9s ²⁾ ,	3	B	3SB38 03-0DA3	1	1 unit
	B = Pushbutton green, label "I",	1 NO,					
	A = Pushbutton red, label "O"	1 NC					
	C = Pushbutton black, label "II"	1 NO,	3	C	3SB38 03-0DB3	1	1 unit
	B = Pushbutton black, label "I",	1 NO,					
	A = Pushbutton red, label "O"	1 NC					
	C = Indicator light clear, label without inscription,	BA 9s ²⁾ ,	3	C	3SB38 03-0DC3	1	1 unit
	B = Pushbutton white, label "I",	1 NO,					
	A = Pushbutton black, label "O"	1 NC					

 For online configurator see www.siemens.com/sirius/configurators.

 Positive opening according to IEC 60947-5-1, Appendix K.

¹⁾ The protective collar must only be used to protect against inadvertent actuating and must be fitted to allow unimpeded access to the EMERGENCY-STOP mushroom pushbutton.

²⁾ Only lamp holder; order lamp separately.

Push Button Units and Indicator Lights







3SB3, Enclosures, 22 mm

Enclosures with standard fittings

Equipment	Contact block function	Number of command points	DT	Screw terminals	⊕	PU (UNIT, SET, M)	PS
				Spring-type terminals ³⁾	∞		
				Configurator	⚙️		
				Order No.			

Metal enclosures with standard fittings

Cable entry top and bottom each 1 x M20

	A = Pushbutton green, label "I"	1 NO	1	B	3SB38 01-2DA3	1	1 unit
	A = Pushbutton red, label "O"	1 NC	1	B	3SB38 01-2DB3	1	1 unit
	A = Pushbutton white, label "I"	1 NO	1	B	3SB38 01-2DD3	1	1 unit
	A = Pushbutton black, label "O"	1 NC	1	B	3SB38 01-2DE3	1	1 unit
	A = EMERGENCY-STOP mushroom pushbutton, Ø 40 mm, with positive latching according to ISO 13850 and rotate-to-unlatch mechanism						
	• With yellow top part, without protective collar	1 NC ⊕	1	B	3SB38 01-2DG3	1	1 unit
		2 NC ⊕	1	B	3SB38 01-2EG3	1	1 unit
	- With M12 socket	2 NC ⊕ ²⁾	1	C	3SB38 01-2EG10-0CC0	1	1 unit
	• With yellow top part, with protective collar ¹⁾	1 NC ⊕	1	B	3SB38 01-2DF3	1	1 unit
		2 NC ⊕	1	B	3SB38 01-2EF3	1	1 unit
	A = EMERGENCY-STOP mushroom pushbutton, Ø 60 mm, with positive latching according to ISO 13850 and rotate-to-unlatch mechanism						
	• With yellow top part, with protective collar for 5 padlocks	2 NC ⊕	1	B	3SB38 01-2EA30	1	1 unit
		2 NC ⊕ ²⁾	1	B	3SB38 01-2EA30-0CC0	1	1 unit
	A = mushroom pushbutton, Ø 60 mm, black, with positive latching and rotate-to-unlatch mechanism						
	• With gray top part, with protective collar for 5 padlocks	2 NC ²⁾	1	B	3SB38 01-2EB30-0CC0	1	1 unit
	B = Pushbutton green, label "I"	1 NO,	2	B	3SB38 02-2DA3	1	1 unit
	A = Pushbutton red, label "O"	1 NC					
	B = Pushbutton white, label "I"	1 NO,	2	B	3SB38 02-2DB3	1	1 unit
	A = Pushbutton black, label "O"	1 NC					
	C = Indicator light clear, label without inscription,	BA 9s ³⁾ ,	3	B	3SB38 03-2DA3	1	1 unit
	B = Pushbutton green, label "I",	1 NO,					
	A = Pushbutton red, label "O"	1 NC					
	C = Pushbutton black, label "II"	1 NO,	3	B	3SB38 03-2DB3	1	1 unit
	B = Pushbutton black, label "I",	1 NO,					
	A = Pushbutton red, label "O"	1 NC					
	C = Indicator light clear, label without inscription,	BA 9s ³⁾ ,	3	B	3SB38 03-2DC3	1	1 unit
	B = Pushbutton white, label "I",	1 NO,					
	A = Pushbutton black, label "O"	1 NC					

⚙️ For online configurator see www.siemens.com/sirius/configurators.

⊕ Positive opening according to IEC 60947-5-1, Appendix K.

¹⁾ The protective collar must only be used to protect against inadvertent actuating and must be fitted to allow unimpeded access to the EMERGENCY-STOP mushroom pushbutton.

²⁾ -0CC0: Contact blocks with spring-type terminals.

³⁾ Only lamp holder; order lamp separately.

Push Button Units and Indicator Lights

3SB3, Enclosures, 22 mm

Empty enclosures

Selection and ordering data

Version	Number of command points	DT	Configurator 	PU (UNIT, SET, M)	PS
			Order No.		

Empty enclosures, plastic



3SB38 02-0AA3

Cable entry top and bottom each 1 x M20 for 1 to 3 command points, each 1 x M25 for 4 and 6 command points

For contact blocks, lamp holders and accessories with snap-on base mounting, also single-pole front plate blocks can be used (switching state is maintained upon opening), with gray top part

1	B	3SB38 01-0AA3	1	1 unit
2	B	3SB38 02-0AA3	1	1 unit
3	B	3SB38 03-0AA3	1	1 unit
4	B	3SB38 04-0AA3	1	1 unit
6	B	3SB38 06-0AA3	1	1 unit



3SB38 01-0AB3

For EMERGENCY-STOP, for contact blocks, lamp holders and accessories with snap-on base mounting, also single-pole front plate blocks can be used (switching state is maintained upon opening)

- With yellow top part, without protective collar

1	B	3SB38 01-0AB3	1	1 unit
---	---	----------------------	---	--------

- With yellow top part, with protective collar¹⁾

1	B	3SB38 01-0AD3	1	1 unit
---	---	----------------------	---	--------

Empty enclosures, metal



3SB38 04-2AA3

Cable entry top and bottom each 1 x M20 for 1 to 3 command points, each 1 x M25 for 4 and 6 command points

For contact blocks, lamp holders and accessories with snap-on base mounting, also single-pole front plate blocks can be used (switching state is maintained upon opening), with gray top part

1	B	3SB38 01-2AA3	1	1 unit
2	B	3SB38 02-2AA3	1	1 unit
3	B	3SB38 03-2AA3	1	1 unit
4	B	3SB38 04-2AA3	1	1 unit
6	B	3SB38 06-2AA3	1	1 unit



3SB38 01-2AB3

For EMERGENCY-STOP, for contact blocks, lamp holders and accessories with snap-on base mounting, also single-pole front plate blocks can be used (switching state is maintained upon opening)

- With yellow top part, without protective collar

1	B	3SB38 01-2AB3	1	1 unit
---	---	----------------------	---	--------

- With yellow top part, with protective collar¹⁾

1	B	3SB38 01-2AD3	1	1 unit
---	---	----------------------	---	--------



3SB38 01-2AD3

- With gray top part, with protective collar

1	B	3SB38 01-2AE3	1	1 unit
---	---	----------------------	---	--------

- With yellow top part, with protective collar for 3 padlocks, for mushroom Ø 40 mm, can be locked (BKS, CES, O.M.R.)

1	B	3SB38 01-2EC3	1	1 unit
---	---	----------------------	---	--------



3SB38 01-2EC3

 For online configurator see www.siemens.com/sirius/configurators.

¹⁾ The protective collar must only be used to protect against inadvertent actuating and must be fitted to allow unimpeded access to the EMERGENCY-STOP mushroom pushbutton.

Push Button Units and Indicator Lights

3SB3, Enclosures, 22 mm

Customized enclosures

1
2
3
4
5
6
7
8
9
10

Overview

Customized enclosures are available with:

- 1 to 6 command points
- Operational voltage up to 400 V

One command point comprises:

- 1 actuator or indicator
- Up to 3 contact blocks or up to 2 contact blocks + 1 lamp holder
- 1 inscription label

For plastic enclosures the command points are equipped as standard with plastic actuators and indicators, for metal enclosures they are equipped with metal actuators and indicators.

For cable entry in each case, a hole is provided at the top and bottom:

- For M20 for 1 to 3 command points
- For M25 for 4 and 6 command points

Ordering notes (selection by configurator)

To order customized enclosures with the 3SB3 control devices (except suspended push buttons), use the 3SB3/3SF5 configurator to select the blocks for equipping. An electronic order form will be generated for the additional options. The configurator is available in the electronic catalog CA 01 on DVD or in the online catalog (Mall) on the Internet:

www.siemens.com/industry/mall

Supplement the Order No. with the order code "K0Y" (as already listed in the selection table).

The list price of the complete enclosure is generated in the configurator for the customized equipment.

Please send the resulting electronic order form along with your order by e-mail to our Competence Center at

sirius-attach.aud@siemens.com

If you are unable to access either catalog, please contact our Technical Assistance.

Selection and ordering data

Version	Number of command points	DT	Configurator 	PU (UNIT, SET, M)	PS
			Order No.		

Plastic enclosures



3SB38 03-.AZ

With contact blocks and lamp holders for base mounting	1	C	3SB38 01-0AZK0Y	1	1 unit
	2	C	3SB38 02-0AZK0Y	1	1 unit
	3	C	3SB38 03-0AZK0Y	1	1 unit
	4	B	3SB38 04-0AZK0Y	1	1 unit
	6	B	3SB38 06-0AZK0Y	1	1 unit
	With single-pole contact blocks and lamp holders for front plate mounting	1	C	3SB38 01-1AZK0Y	1
2		C	3SB38 02-1AZK0Y	1	1 unit
3		C	3SB38 03-1AZK0Y	1	1 unit
4		B	3SB38 04-1AZK0Y	1	1 unit
6		B	3SB38 06-1AZK0Y	1	1 unit

Metal enclosures



3SB38 03-.AZ

With contact blocks and lamp holders for base mounting	1	C	3SB38 01-2AZK0Y	1	1 unit
	2	C	3SB38 02-2AZK0Y	1	1 unit
	3	C	3SB38 03-2AZK0Y	1	1 unit
	4	C	3SB38 04-2AZK0Y	1	1 unit
	6	C	3SB38 06-2AZK0Y	1	1 unit
	With single-pole contact blocks and lamp holders for front plate mounting	1	C	3SB38 01-3AZK0Y	1
2		C	3SB38 02-3AZK0Y	1	1 unit
3		C	3SB38 03-3AZK0Y	1	1 unit
4		C	3SB38 04-3AZK0Y	1	1 unit
6		C	3SB38 06-3AZK0Y	1	1 unit

 For online configurator see www.siemens.com/sirius/configurators.

Push Button Units and Indicator Lights

3SB3, Enclosures, 22 mm









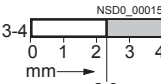

Contact blocks and lamp holders

Selection and ordering data

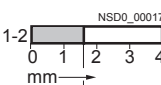
For self-equiping of the enclosures

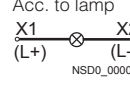
Version	Rated voltage/ Diagram	Operating travel/color <input type="checkbox"/> Contact closed <input type="checkbox"/> Contact open	DT	Screw terminals 	PU (UNIT, SET, M)	PS
				Order No.		

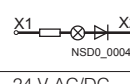
Contact blocks for base mounting

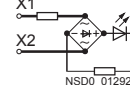
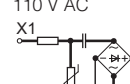
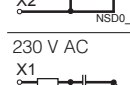
	Contact blocks with one contact							
	1 NO 1 NO with gold-plated contacts			▶	3SB34 20-0B	1	1 unit	
	1 NC 1 NC with gold-plated contacts			▶	3SB34 20-0C	1	1 unit	
				▶	3SB34 20-0CA	1	1 unit	
	BA 9s lamp holders							
	Without lamp	Acc. to lamp 		▶	3SB34 20-1A	1	1 unit	
	With integrated voltage reducer and with 130 V lamp (3SX1 731) ¹⁾	230/240 V AC 	Clear	B	3SB34 20-1C	1	1 unit	
		Lamp holders with integrated LED						
24 V AC/DC			Yellow Red Green Blue White	B ▶ ▶ B ▶	3SB34 20-1PA 3SB34 20-1PB 3SB34 20-1PC 3SB34 20-1PD 3SB34 20-1PE	1 1 1 1 1	1 unit 1 unit 1 unit 1 unit 1 unit	
110 V AC			Yellow Red Green Blue White	B B B D B	3SB34 20-1QA 3SB34 20-1QB 3SB34 20-1QC 3SB34 20-1QD 3SB34 20-1QE	1 1 1 1 1	1 unit 1 unit 1 unit 1 unit 1 unit	
230 V AC			Yellow Red Green Blue White	B B B B B	3SB34 20-1RA 3SB34 20-1RB 3SB34 20-1RC 3SB34 20-1RD 3SB34 20-1RE	1 1 1 1 1	1 unit 1 unit 1 unit 1 unit 1 unit	
Fixpoint terminals								
				Black Blue Green/Yellow	B B B	3SB39 01-0AG 3SB39 01-0AH 3SB39 01-0AJ	1 1 1	1 unit 1 unit 1 unit

 Positive opening according to IEC 60947-5-1, Appendix K.

¹⁾ Only use with this lamp.

Push Button Units and Indicator Lights

3SB3, Enclosures, 22 mm

Contact blocks and lamp holders

1
2
3
4
5
6
7
8
9
10

Version	Rated voltage/ Diagram	Operating travel/color <input type="checkbox"/> Contact closed <input type="checkbox"/> Contact open	DT	Spring-type terminals 	PU (UNIT, SET, M)	PS
				Order No.		

Contact blocks for base mounting



3SB34 23-0B

Contact blocks with one contact

1 NO
1 NO with
gold-plated contacts

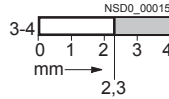

B **3SB34 23-0B**
D **3SB34 23-0BA**

1 1 unit
1 1 unit

1 NC
1 NC with
gold-plated contacts

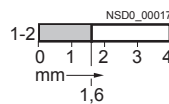

B **3SB34 23-0C**
B **3SB34 23-0CA**

1 1 unit
1 1 unit

Lamp holders with integrated LED

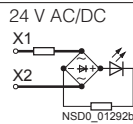

Yellow
Red
Green
Blue
White

B **3SB34 23-1PA**
B **3SB34 23-1PB**
B **3SB34 23-1PC**
B **3SB34 23-1PD**
B **3SB34 23-1PE**

1 1 unit
1 1 unit
1 1 unit
1 1 unit
1 1 unit

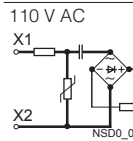

Yellow
Red
Green
Blue
White

B **3SB34 23-1QA**
D **3SB34 23-1QB**
D **3SB34 23-1QC**
D **3SB34 23-1QD**
D **3SB34 23-1QE**

1 1 unit
1 1 unit
1 1 unit
1 1 unit
1 1 unit

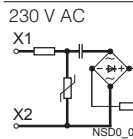

Yellow
Red
Green
Blue
White

D **3SB34 23-1RA**
B **3SB34 23-1RB**
B **3SB34 23-1RC**
B **3SB34 23-1RD**
B **3SB34 23-1RE**

1 1 unit
1 1 unit
1 1 unit
1 1 unit
1 1 unit

Fixpoint terminals

Black
Blue
Green/Yellow

B **3SB34 23-2F**
B **3SB34 23-2G**
B **3SB34 23-2H**

1 1 unit
1 1 unit
1 1 unit



3SB34 23-2G

↻ Positive opening according to IEC 60947-5-1, Appendix K.

Version	DT	Order No.	PU (UNIT, SET, M)	PS

Accessories



3SB39 01-0AW

Pressure plates for selector switches and key-operated switches
For actuating the central contact block of 3 contact blocks

B **3SB39 01-0AW**

100 10 units

Push Button Units and Indicator Lights

3SB3, Enclosures, 22 mm

Inscription labels for enclosures

Overview

Inscription labels

The inscription labels (black with white inscription or silver-colored with black print) have an adhesive layer on the back. The size of the labels is 22 mm x 22 mm.

Inscriptions

The inscriptions have upper case initial letters. The typeface is Arial. Graphic symbols, including those not listed in the catalog, are according to ISO 7000 or IEC 60417 (see page 10/95).

Selection and ordering data

Inscriptions	DT	Black Order No.	DT	Silver-colored Order No.
Inscription labels, self-adhesive, 22 mm x 22 mm				
<i>For self-inscription</i>				
Blank	B	3SB39 06-1AA	B	3SB19 01-3AA
<i>With inscription</i>				
On	B	3SB39 06-1EB	B	3SB19 01-3EB
Off	B	3SB39 06-1EC	B	3SB19 01-3EC
Up	B	3SB39 06-1ED	B	3SB19 01-3ED
Down	B	3SB39 06-1EE	B	3SB19 01-3EE
Open	B	3SB39 06-1EP	B	3SB19 01-3EP
Close	B	3SB39 06-1EQ	B	3SB19 01-3EQ
Forward	B	3SB39 06-1EF	B	3SB19 01-3EF
Reverse	B	3SB39 06-1EG	B	3SB19 01-3EG
Right	B	3SB39 06-1EH		—
Left	B	3SB39 06-1EJ		—
Fast	B	3SB39 06-1ER		—
Slow	B	3SB39 06-1ES		—
Running	B	3SB39 06-1EV	B	3SB19 01-3EV
Fault	B	3SB39 06-1EW		—
Operation	B	3SB39 06-1AP		—
Start	B	3SB39 06-1EL	B	3SB19 01-3EL
Reset	B	3SB39 06-1EM	B	3SB19 01-3EM
Test	B	3SB39 06-1EN	B	3SB19 01-3EN
Stop	B	3SB39 06-1EK	B	3SB19 01-3EK
EMERGENCY STOP	B	3SB39 06-1EY	B	3SB19 01-3EY
<i>Equipment</i>				
Fan	B	3SB39 06-1CA		—
Pump	B	3SB39 06-1CB		—
Cooling	B	3SB39 06-1CC		—
Heating	B	3SB39 06-1CD		—
Lighting	B	3SB39 06-1CE		—
Filter	B	3SB39 06-1CF		—
Motor	B	3SB39 06-1CG		—
Compressor	B	3SB39 06-1CH		—
<i>With graphic symbol</i>				
O	B	3SB39 06-1MB	B	3SB19 01-3MB
I	B	3SB39 06-1MC	B	3SB19 01-3MC
II	B	3SB39 06-1MD	B	3SB19 01-3MD
III	B	3SB39 06-1ME	B	3SB19 01-3ME
O I (horizontal)	B	3SB39 06-1MF	B	3SB19 01-3MF
I O II (horizontal)	B	3SB39 06-1MG	B	3SB19 01-3MG
I O (vertical)	B	3SB39 06-1MH	B	3SB19 01-3MH
II O I (vertical)	B	3SB39 06-1MW	C	3SB19 01-3MW
	B	3SB39 06-1NA	B	3SB19 01-3NA
Inscription labels, self-adhesive, 22 mm x 22 mm				
<i>With customized inscription</i>				
For inscriptions or symbols see "Options"		3SB39 06-0XZ		3SB19 01-3XZ
• Text line(s)	B	K0Y	B	K0Y
• Text line(s) or symbol with No.	B	K1Y, K2Y, K3Y or K5Y	B	K1Y, K2Y, K3Y or K5Y
• Any inscription or symbol	B	K9Y	B	K9Y

For customized inscriptions see page 10/72.











Push Button Units and Indicator Lights

3SB3, Enclosures, 22 mm

Accessories for enclosures

1
2
3
4
5
6
7
8
9
10

Selection and ordering data

Version	Color/ inscription	DT	Order No.	PU (UNIT, SET, M)	PS
Blanking plugs for spare command points					
 3SB39 21-0AA	Blanking plugs For plastic version, round	Black	▶ 3SB39 21-0AA	1	10 units
 3SB19 02-0AQ	Blanking plugs (plastic) For metal version, round	Aluminized	B 3SB19 02-0AQ	1	10 units
Holders and pressure plates					
 3SB39 01-0AB	Holders for push buttons and switches For snapping on 3 blocks, ¹⁾ for front plate mounting		▶ 3SB39 01-0AB	100	20 units
 3SB39 01-0AC	Holders for selector switches and key-operated switches with pressure plate For actuating a central contact block, for front plate mounting ²⁾		▶ 3SB39 01-0AC	100	10 units
 3SB39 01-0AW	Pressure plates for selector switches and key-operated switches For actuating a central contact block, for base mounting ²⁾		B 3SB39 01-0AW	100	10 units
Accessories for enclosures					
	Yellow name plates As backing plate for EMERGENCY-STOP, self-adhesive	Without inscription	D 3SB19 02-1AQ	1	1 unit
		With recess for inscription label	B 3SB39 21-0BV	1	1 unit
 3SB39 01-0CK	Cable gland includes hexagonal nut	• M20	B 3SB39 01-0CK	1	1 unit
		• M25	B 3SB39 01-0CM	1	1 unit
		• Pg 16	B 3SB39 01-0AK	1	1 unit
		• Pg 22	B 3SB39 01-0AM	1	1 unit
 3SB39 01-0CL	Hexagonal nuts For cable glands	• M25	B 3SB39 01-0CL	100	10 units
		• M20	B 3SB39 01-0CN	100	10 units
		• Pg 16	B 3SB39 01-0AL	100	10 units
		• Pg 22	B 3SB39 01-0AN	100	10 units
 3SB39 01-0CS	Connecting pieces For connecting 2 plastic enclosures	• M20/M20	B 3SB39 01-0CS	1	1 unit
		• M20/M25 ³⁾	B 3SB39 01-0CT	1	1 unit
		• M25/M25	B 3SB39 01-0CU	1	1 unit
 3SB39 01-0CP	Connecting pieces For connecting 2 metal enclosures	• M20/M20	B 3SB39 01-0CP	1	1 unit
		• M20/M25	B 3SB39 01-0CQ	1	1 unit
	Pg 16 terminal for AS interface cable suitable receptacles: crimp snap-in contacts 0.2–0.56 mm ²		B 3SB39 01-0AF	1	1 unit

¹⁾ The holder for illuminated commanding devices is included in the scope of supply.

²⁾ The pressure plates can be removed one by one to meet individual requirements.

³⁾ Not suitable for plastic enclosures with 6 command points.

Push Button Units and Indicator Lights

3SB3, Enclosures for AS-Interface, 22 mm

General data

Overview



AS-Interface enclosure with customized equipment

Distributed command devices of the 3SB3 series can be quickly connected to the AS-Interface using AS-Interface enclosures. Using suitable components you can make your own enclosures with integrated AS-Interface or flexibly modify existing enclosures.

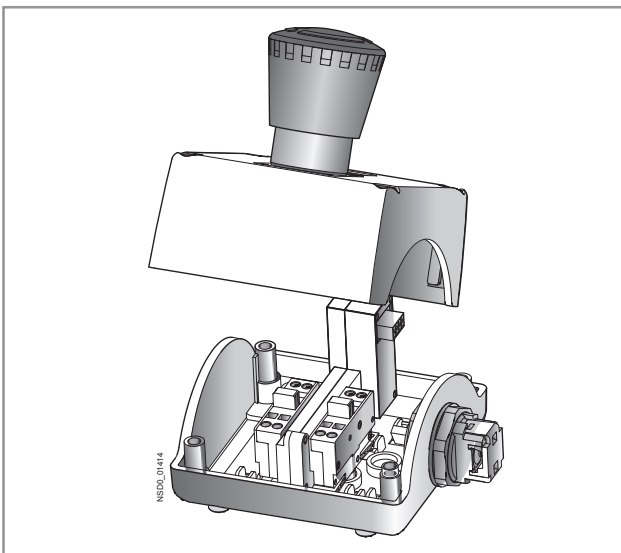

EMERGENCY-STOP enclosure

Enclosures

Color of enclosure cover:

- Gray, RAL 7035, or
- Yellow, RAL 1004, for EMERGENCY-STOP.

Color of enclosure base:

- Black, RAL 9005

Installation of AS-Interface slaves

The following slave types are available for connecting the command points:

- Slave in A/B technology with 4 inputs and 3 outputs
- Slave with 4 inputs and 4 outputs
- F Slave with two secure inputs for EMERGENCY-STOP mushroom pushbutton

The following table shows the maximum number of equippable slaves:

Enclosures for	Number of slaves for enclosures without EMERGENCY-STOP	Number of slaves for enclosures with EMERGENCY-STOP
1 command point	Not available	1 x F slave
2 command points	1 x slave 4I/4O or 4I/3O	Not available
3 command points	1 x slave 4I/4O or 4I/3O	1 x slave 4I/4O or 4I/3O + 1 x F slave
4 command points	2 x slave 4I/4O or 4I/3O ¹⁾	2 x slave 4I/4O or 4I/3O + 1 x F slave ¹⁾
6 command points	2 x slave 4I/4O or 4I/3O	2 x slave 4I/4O or 4I/3O + 1 x F slave

¹⁾ For metal enclosures with 4 command points, only 1 x slave 4I/4O or 4I/3O is possible.

Connection

One set of links is required in each case to connect a slave to contact blocks, to lamp holders and to the connection element.

The connection elements are mounted in the front-end cable glands and are used for connection of the AS-Interface or for bringing unused inputs or outputs out of the enclosure.

For connection to AS-Interface it can be selected between:

- Terminal for shaped AS-Interface cable. The cable is contacted by the insulation piercing method and routed past the enclosure on the outside (possible only with plastic enclosure).
- Cable gland for the shaped AS-Interface cable or round cable. The cable is routed into the enclosure (preferable for metal enclosure).
- Connection using M12 plug.

If less than all inputs/outputs of the installed slaves in an enclosure are used for connecting the command devices, free inputs and outputs can be routed on request to the outside through an M12 socket on the top or bottom side of the enclosure.

To supply inputs with power, the S+ connection of the slave must be assigned to the socket, for outputs the OUT- connection must be assigned.

Addressing is performed using the AS-Interface connections or the integrated addressing socket. An external power supply is not required.

Customized enclosures (selection by configurator)

To order customized 3SF58 AS-Interface enclosures with the 3SB3 control devices, use the 3SB3/3SF5 configurator to select the blocks for equipping. An electronic order form will be generated for the additional options.

For related ordering notes see page 10/91

Push Button Units and Indicator Lights

3SB3, Components for Actuators and Indicators, 22 mm

AS-Interface F adapters for EMERGENCY-STOP devices

1

2

3

4

5

6

7

8

9

10

Overview

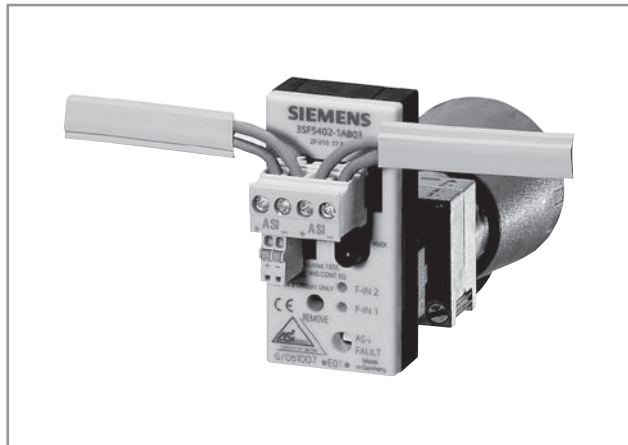

EMERGENCY-STOP mushroom push button with F adapter for bus connection

The AS-Interface F adapter is used to connect an EMERGENCY-STOP device according to ISO 13850 from the 3SB3 series to the AS-Interface bus system. The F adapter is suitable for control devices with mounting on front plates.

The F adapter has a safe AS-Interface 2I slave and is snapped from behind onto the EMERGENCY-STOP mushroom push button. In the 2I/1O expanded version, an output is also available for actuating an indicator light with LED.

Depending on the version, screw terminals or spring-type terminals or the insulation piercing method are used for connecting to the AS-Interface bus cable. Addressing is performed using the AS-Interface connection or the integrated addressing socket.

Safety category 4 (SIL 3) is achieved with the adapter.

Selection and ordering data

Version	DT	Screw terminals	PS
---------	----	-----------------	----

Order No.	
3SF5 402-1AA03	1 unit
3SF5 402-1AB03	1 unit



3SF5 402-1AA03

AS-Interface F adapter for 3SB3 EMERGENCY-STOP mushroom push buttons

For mounting on front plates

- 2I
- 2I/1O, with output for LED control

Version	DT	Spring-type terminals	PS
---------	----	-----------------------	----

Order No.	
3SF5 402-1AA04	1 unit
3SF5 402-1AB04	1 unit



3SF5 402-1AA04

AS-Interface F adapter for 3SB3 EMERGENCY-STOP mushroom push buttons

For mounting on front plates

- 2I
- 2I/1O, with output for LED control

Version	DT	Insulation piercing method	PS
---------	----	----------------------------	----

Order No.	
3SF5 402-1AA05	1 unit
3SF5 402-1AB05	1 unit



3SF5 402-1AA05

AS-Interface F adapter for 3SB3 EMERGENCY-STOP mushroom push buttons

For mounting on front plates

- 2I
- 2I/1O, with output for LED control

Push Button Units and Indicator Lights

3SB3, Enclosures for AS-Interface, 22 mm

AS-Interface enclosures with standard fittings

Overview

Enclosures with standard fittings are available with:

- 1 to 3 command points
- Operational voltage through AS-Interface (approx. 30 V)
- Vertical mounting type
- Plastic enclosures are equipped with plastic actuators and indicators, metal enclosures are equipped with metal actuators and indicators





The enclosures without EMERGENCY-STOP each have one user module with 4I/3O; the enclosures with EMERGENCY-STOP mushroom push buttons have a safe AS-Interface slave integrated in the enclosure.

Enclosures with EMERGENCY-STOP mushroom push buttons are fitted with two NC contact blocks, which are wired to the safe slave. The contact blocks and lamp holders (with spring-type terminals) of the control device, and the AS-Interface slaves, are mounted in the base of the enclosure and are cable-connected.

The plastic enclosures are designed with a connection for the AS-Interface flat cable (the cable is run passed the outside of the enclosure). For metal enclosures, the AS-Interface cable is run inside the enclosure.

The housing with EMERGENCY-STOP mushroom push buttons with an M12 connector is also available.

Selection and ordering data

Equipping options (A, B, C = identification letters of the command points)		Number of command points	DT	Configurator 	PU (UNIT, SET, M)	PS
				Order No.		
AS-Interface enclosures, plastic						
<i>With M12 top connector</i>						
	A = EMERGENCY-STOP mushroom push buttons, with rotate-to-unlatch mechanism, 1 NC, 1 NC, yellow enclosure top	1	B	3SF5 811-0AA10	1	1 unit
<i>With terminal for insulation piercing method at top</i>						
	A = EMERGENCY-STOP mushroom push buttons, with rotate-to-unlatch mechanism, 1 NC, 1 NC					
	• Yellow enclosure top	1	A	3SF5 811-0AA08	1	1 unit
	• Yellow enclosure top, with protective collar	1	A	3SF5 811-0AB08	1	1 unit
	B = Pushbutton green, label "I", 1 NO A = Pushbutton red, label "O", 1 NO	2	A	3SF5 812-0DA00	1	1 unit
	B = Pushbutton white, label "I", 1 NO A = Pushbutton black, label "O", 1 NO	2	A	3SF5 812-0DB00	1	1 unit
	C = Indicator lights clear, label without inscription	3	A	3SF5 813-0DA00	1	1 unit
	B = Pushbutton green, label "I", 1 NO A = Pushbutton red, label "O", 1 NO					
	C = Indicator lights clear, label without inscription	3	A	3SF5 813-0DC00	1	1 unit
	B = Pushbutton white, label "I", 1 NO A = Pushbutton black, label "O", 1 NO					
	C = Pushbutton black, label "II", 1 NO B = Pushbutton black, label "I", 1 NO A = Pushbutton red, label "O", 1 NO	3	A	3SF5 813-0DB00	1	1 unit
AS-Interface enclosures, metal						
<i>With M12 top connector</i>						
	A = EMERGENCY-STOP mushroom push buttons, with rotate-to-unlatch mechanism, 1 NC, 1 NC					
	• Yellow enclosure top	1	C	3SF58 11-2AA10	1	1 unit
	• Yellow enclosure top, with protective collar	1	C	3SF58 11-2AB10	1	1 unit
<i>With cable gland at top</i>						
	A = EMERGENCY-STOP mushroom push buttons, with rotate-to-unlatch mechanism, 1 NC, 1 NC					
	• Yellow enclosure top	1	A	3SF5 811-2AA08	1	1 unit
	• Yellow enclosure top, with protective collar	1	A	3SF5 811-2AB08	1	1 unit
	B = Pushbutton green, label "I", 1 NO A = Pushbutton red, label "O", 1 NO	2	A	3SF5 812-2DA00	1	1 unit
	B = Pushbutton white, label "I", 1 NO A = Pushbutton black, label "O", 1 NO	2	A	3SF5 812-2DB00	1	1 unit
	C = Indicator lights clear, label without inscription	3	A	3SF5 813-2DA00	1	1 unit
	B = Pushbutton green, label "I", 1 NO A = Pushbutton red, label "O", 1 NO					
	C = Indicator lights clear, label without inscription	3	A	3SF5 813-2DC00	1	1 unit
	B = Pushbutton white, label "I", 1 NO A = Pushbutton black, label "O", 1 NO					
	C = Pushbutton black, label "II", 1 NO B = Pushbutton black, label "I", 1 NO A = Pushbutton red, label "O", 1 NO	3	A	3SF5 813-2DB00	1	1 unit

For online configurator see www.siemens.com/sirius/configurators.

Push Button Units and Indicator Lights



3SB3, Enclosures for AS-Interface, 22 mm

Components for AS-Interface enclosures

1
2
3
4
5
6
7
8
9
10

Selection and ordering data

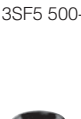
For self-equipping of the enclosures

Version	Number of command points	DT	Order No.	PU (UNIT, SET, M)	PS
For plastic enclosures					
 3SF5 500-0BA	AS-Interface slaves F slave, 2 safe inputs, for plastic enclosure, EMERGENCY-STOP, without protective collar	1 ... 6	A	3SF5 500-0BA	1 1 unit
	F slave, 2 safe inputs, for plastic or metal enclosure, EMERGENCY-STOP, with protective collar	1	A	3SF5 500-0DA	1 1 unit
 3SF5 500-0BB	A/B slave, 4I/3O for plastic enclosure	2 ... 6	A	3SF5 500-0BB	1 1 unit
	Slave, 4I/4O, for plastic enclosure	2 ... 6	A	3SF5 500-0BC	1 1 unit
Sets of links					
 3SF5 900-0CA	For F slave		A	3SF5 900-0BA	1 1 unit
	For slave 4I/4O or A/B slave 4I(3O)		A	3SF5 900-0BB	1 1 unit
Connection elements					
 3SF5 900-0CC	For AS-Interface shaped cable, connection by insulation piercing method, for plastic enclosure	1 ... 3	A	3SF5 900-0CA	1 1 unit
		4 ... 6	B	3SF5 900-0CB	1 1 unit
 3SF5 900-0CD	For AS-Interface connection using M12 plug, for plastic enclosure	1 ... 3	B	3SF5 900-0CC	1 1 unit
		4 ... 6	B	3SF5 900-0CD	1 1 unit
 3SF5 900-0CE	For bringing out unused inputs/outputs through an M12 socket, for plastic enclosure	1 ... 3	B	3SF5 900-0CE	1 1 unit
		4 ... 6	B	3SF5 900-0CF	1 1 unit
 3SF5 900-0CG	For AS-Interface shaped cable, cable is routed into the enclosure, for plastic or metal enclosure	1 ... 3	A	3SF5 900-0CG	1 1 unit
		4 ... 6	A	3SF5 900-0CH	1 1 unit
 3SF5 900-0CJ	For round cable, cable is routed into the enclosure, for plastic or metal enclosure	1 ... 3	A	3SF5 900-0CJ	1 1 unit
		4 ... 6	A	3SF5 900-0CK	1 1 unit
For metal enclosures					
 3SF5 500-0CB	AS-Interface slaves F slave, 2 safe inputs, for metal enclosure, EMERGENCY-STOP, without protective collar	1 ... 6	A	3SF5 500-0CA	1 1 unit
	F slave, 2 safe inputs, for plastic or metal enclosure, EMERGENCY-STOP, with protective collar	1	A	3SF5 500-0DA	1 1 unit
	A/B slave, 4I/3O, for metal enclosure	2 ... 6	A	3SF5 500-0CB	1 1 unit
	Slave, 4I/4O, for metal enclosure	2 ... 6	A	3SF5 500-0CC	1 1 unit
Sets of links					
 3SF5 900-0CC	For F slave		A	3SF5 900-0BA	1 1 unit
	For slave 4I/4O or A/B slave 4I(3O)		A	3SF5 900-0BB	1 1 unit
Connection elements					
 3SF5 900-0CD	For AS-Interface connection using M12 plug, for metal enclosure	1 ... 3	B	3SF5 900-2CC	1 1 unit
		4 ... 6	B	3SF5 900-2CD	1 1 unit
 3SF5 900-0CE	For bringing out unused inputs/outputs through an M12 socket, for metal enclosure	1 ... 3	B	3SF5 900-2CE	1 1 unit
		4 ... 6	B	3SF5 900-2CF	1 1 unit
 3SF5 900-0CG	For AS-Interface shaped cable, cable is routed into the enclosure, for plastic or metal enclosure	1 ... 3	A	3SF5 900-0CG	1 1 unit
		4 ... 6	A	3SF5 900-0CH	1 1 unit
 3SF5 900-0CJ	For round cable, cable is routed into the enclosure, for plastic or metal enclosure	1 ... 3	A	3SF5 900-0CJ	1 1 unit
		4 ... 6	A	3SF5 900-0CK	1 1 unit

Push Button Units and Indicator Lights

SIRIUS 3SB3

Dimension drawings (mm) Operator and indicator elements

Dimension drawings

Mounting dimensions

Round design

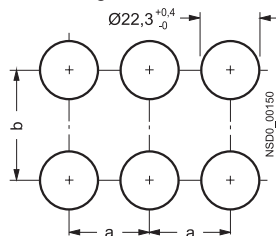

Square design

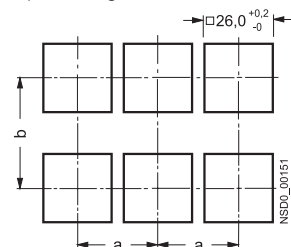

Minimum clearance

	a	b
Switch blocks (1 contact) and lampholder		
• for front plate mounting, with screw terminals	30 ¹⁾	45
• for front plate mounting, with spring-loaded terminals	30 ¹⁾	30 ¹⁾
• for use on PCB, with solder pins	30 ¹⁾	30 ¹⁾
Switch blocks with 2 contacts		
• for front plate mounting	30 ¹⁾	50
When using holders for labeling plates		
• 12.5 mm x 27 mm	30 ¹⁾	45 ²⁾
• 27.0 mm x 27 mm	30 ¹⁾	60

1) For mushroom pushbutton, EMERGENCY-STOP and push-pull button:
Note mushroom diameter d = 40 mm or 60 mm.

2) 60 mm with switch blocks having two contacts.

Molded-plastic version, round

Pushbutton or illuminated pushbutton
with flat pushbutton
and single-pole switch block
(and lampholder)

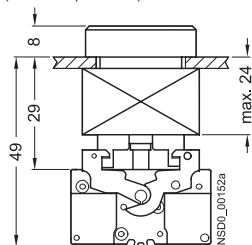

Pushbutton or illuminated pushbutton
with raised button

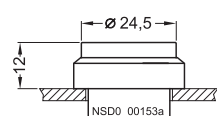

Pushbutton
with raised front ring

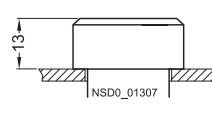

Pushbutton
with raised front ring castellated

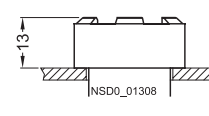

Mushroom pushbutton, illuminated mushroom pushbutton, push-pull-button or illuminated push-pull-button,
? 30 mm

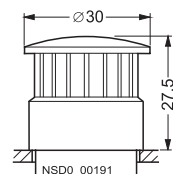

Mushroom pushbutton, illuminated mushroom pushbutton, push-pull-button or illuminated push-pull-button,
? 40 mm

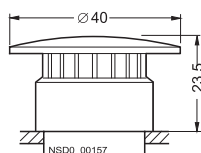

Mushroom pushbutton, illuminated mushroom pushbutton, push-pull-button or illuminated push-pull-button,
? 60 mm

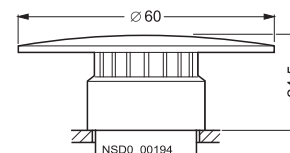

Selector switch or illuminated selector switch

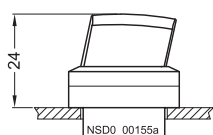

RONIS key-operated switch

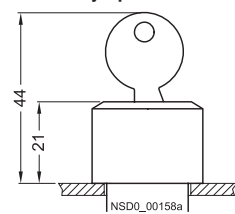

BKS, CES, IKON, O.M.R. key-operated switches

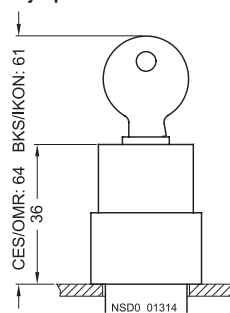

Joystick switch

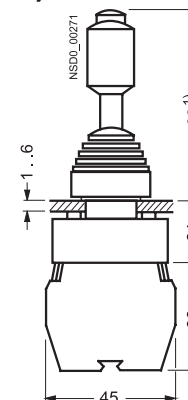

Pushbutton
with raised button, latching

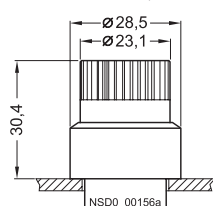

Operating mechanism for potentiometer
with shaft \varnothing 6 mm,
30 ... 32 mm long

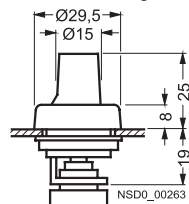

Pushbutton with extended stroke

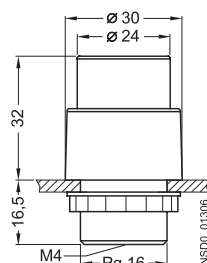

1) 82 with mechanical interlock,
77 without mechanical interlock

Push Button Units and Indicator Lights

SIRIUS 3SB3

Dimension drawings (mm)
Operator and indicator elements

1

2

3

4

5

6

7

8

9

10

EMERGENCY-STOP mushroom pushbutton,
Ø 32 mm, pull to unlatch

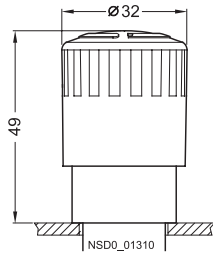

EMERGENCY-STOP mushroom pushbutton,
Ø 40 mm, pull to unlatch

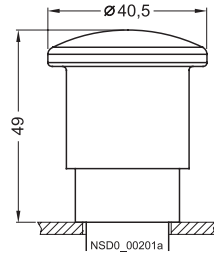

EMERGENCY-STOP mushroom pushbutton,
Ø 40 mm, pull to unlatch

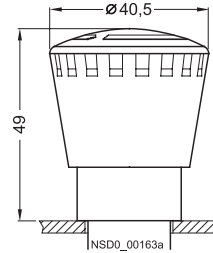

EMERGENCY-STOP mushroom pushbutton,
Ø 60 mm, rotate to unlatch

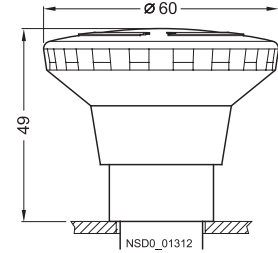

EMERGENCY-STOP mushroom pushbutton
with RONIS key-operated switch

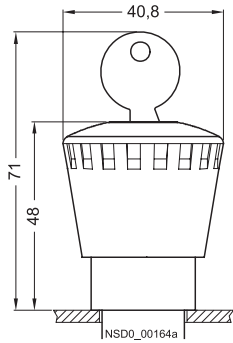

EMERGENCY-STOP mushroom pushbutton
with BKS, CES, IKON, O.M.R.
key-operated switch

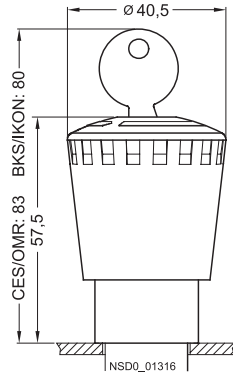

Indicator light

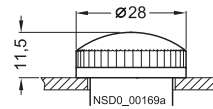

Gear Holder

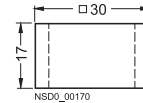

Audible signal device

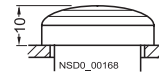

Hole plug

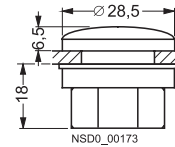

On-Off pushbutton
with flat buttons

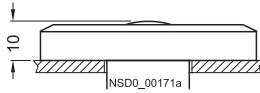

On-Off pushbutton
with raised buttons

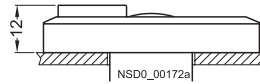

On-Off pushbutton
with or without indicator light

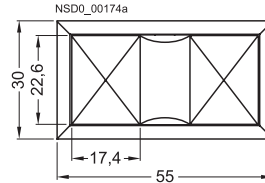

Top view

Operating mechanism for potentiometer
with shaft Ø 6 mm,
30 ... 32 mm long

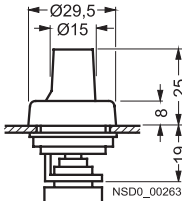

Pushbutton with extended stroke

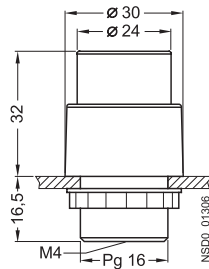

Push Button Units and Indicator Lights

SIRIUS 3SB3

Dimension drawings (mm) Operator and indicator elements

Plastic version, square

Pushbutton or illuminated pushbutton with flat pushbutton

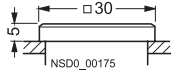

Indicator light

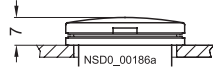

Selector switch or illuminated selector switch

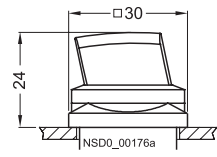

RONIS key-operated switch

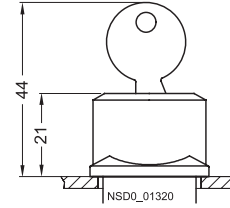

BKS, CES, IKON, O.M.R. key-operated switch

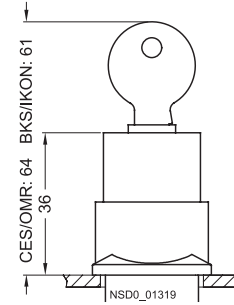

EMERGENCY-STOP mushroom pushbutton with safety lock

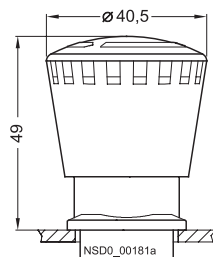

EMERGENCY-STOP mushroom pushbutton with RONIS key-operated switch

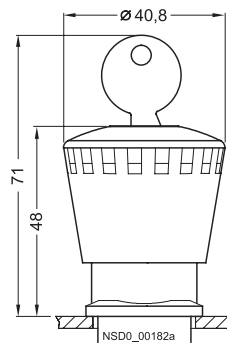

EMERGENCY-STOP mushroom pushbutton with BKS, CES, IKON, O.M.R. key-operated switch

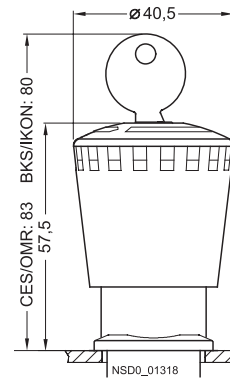

Gear Holder

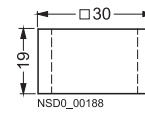

Hole plug

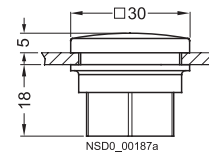

Metal version, round

Pushbutton or illuminated pushbutton

with flat button and single-pole switch block (and lampholder)

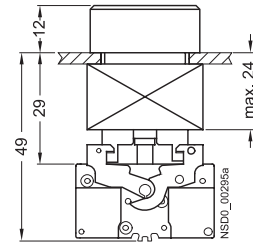

Selector switch or illuminated selector switch, standard

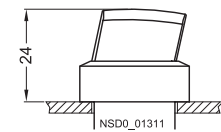

Selector switch or illuminated selector switch, heavy duty

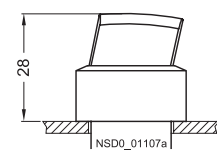

EMERGENCY-STOP mushroom pushbutton, Ø 32 mm, rotate to unlatch

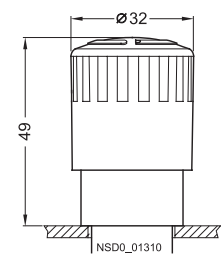

EMERGENCY-STOP mushroom pushbutton with RONIS key-operated switch

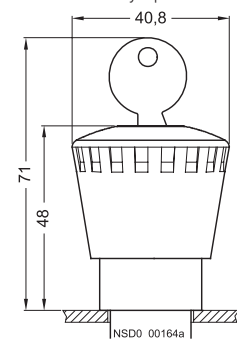

Pushbutton or illuminated pushbutton with raised button

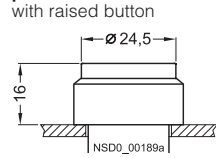

Mushroom pushbutton, illuminated mushroom pushbutton, push-pull-button or illuminated push-pull-button, ? 30 mm

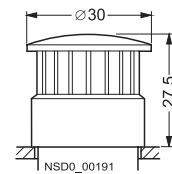

Selector switch or illuminated selector switch with long handle

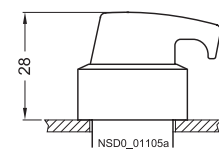

EMERGENCY-STOP mushroom pushbutton, Ø 40 mm, pull to unlatch

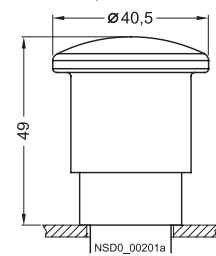

EMERGENCY-STOP mushroom pushbutton with BKS, CES, IKON, O.M.R. key-operated switch

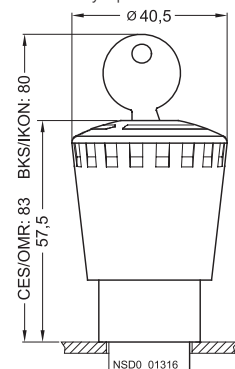

Pushbutton or illuminated pushbutton, latching, with flat button

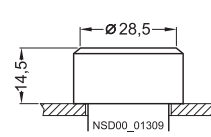

Mushroom pushbutton, illuminated mushroom pushbutton, push-pull-button or illuminated push-pull-button, ? 40 mm

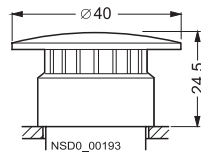

RONIS key-operated switch

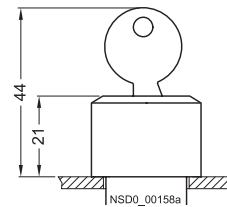

EMERGENCY-STOP mushroom pushbutton, Ø 40 mm, rotate to unlatch

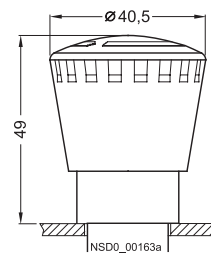

Indicator light

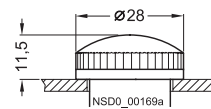

Pushbutton with raised front ring

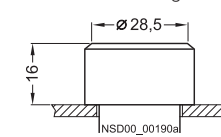

Mushroom pushbutton, illuminated mushroom pushbutton, push-pull-button or illuminated push-pull-button, ? 60 mm

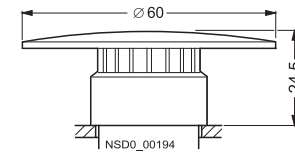

BKS, CES, IKON, O.M.R. key-operated switches

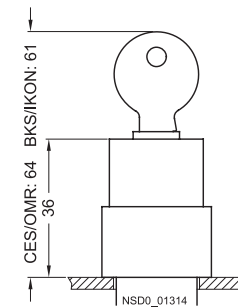

EMERGENCY-STOP mushroom pushbutton, Ø 60 mm, rotate to unlatch

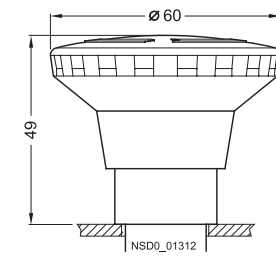

Gear Holder

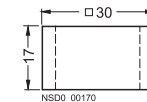

Push Button Units and Indicator Lights

SIRIUS 3SB3

Dimension drawings (mm) Contact blocks and lamp holders

Contact blocks and lampholders

Screw connection, for front plate mounting

Switch block with 1 contact

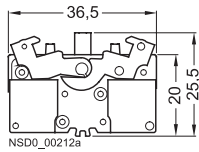

Switch block with 2 contacts

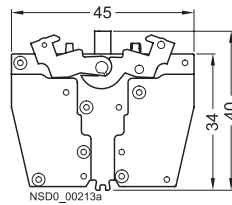

BA 9s lampholder with or without integrated voltage reducer

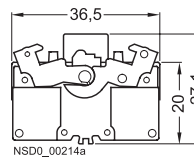

BA 9s lampholder with separate lamp test function

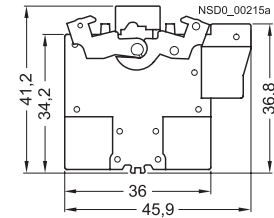

Lampholder with integrated LED

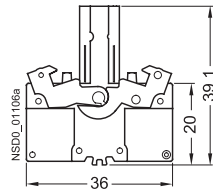

Pushbutton or illuminated pushbutton with switch blocks with 1 contact

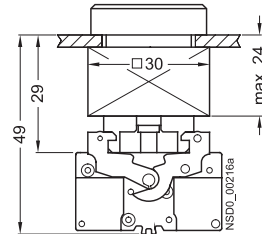

Pushbutton with switch blocks with 1 contact

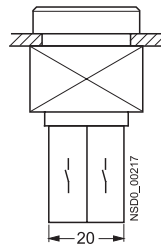

Illuminated pushbutton with switch blocks with 1 contact and lampholder

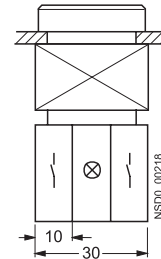

Pushbutton or illuminated pushbutton with switch blocks with 2 contacts

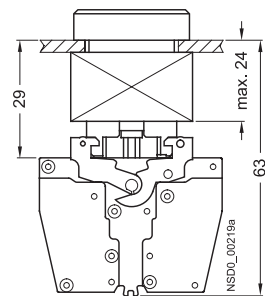

Illuminated pushbutton with switch blocks with 2 contacts and lampholder

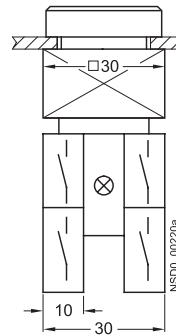

Illuminated pushbutton with switch blocks with 1 contact and lampholder with snapped-on transformer

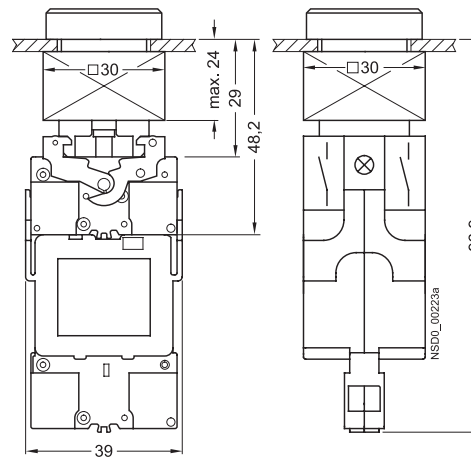

Spring-loaded terminals, for front plate mounting

Switch block with 1 contact

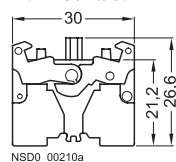

Switch block with 2 contacts

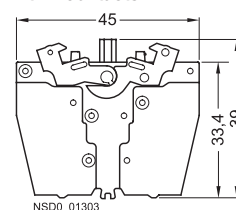

Lampholder BA 9s

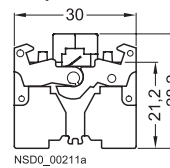

Lampholder with integrated LED

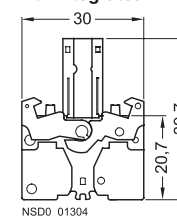

With solder pins, for use on PCB

Contact block 1 NO and 1 NC

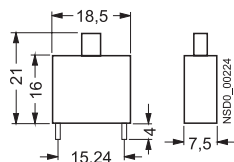

Lampholder

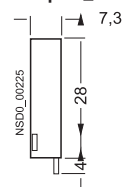

Solder pin spacing

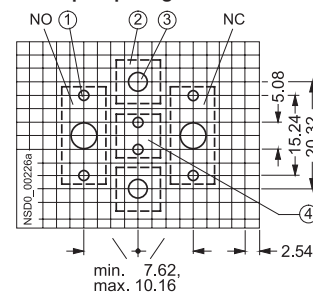

Pushbutton or illuminated pushbutton with contact blocks with 1 contact and PCB support

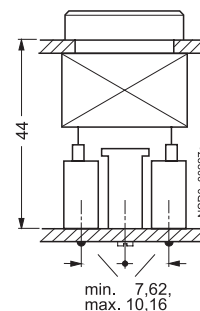

- ① Solder pin $\varnothing 1.3^{+0.1}$
- ② PCB holder
- ③ Centering hole $\varnothing 4.2^{+0.1}$
- ④ Lampholder

Accessories

3SB39 21-0AK shroud

for front plate mounting ¹⁾
for EMERGENCY-STOP mushroom
pushbutton without key-operated switch.

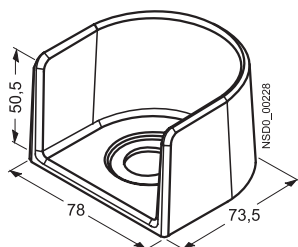

3SB39 21-0AX shroud

for front plate mounting ¹⁾
for EMERGENCY-STOP mushroom
pushbutton with key-operated switch.

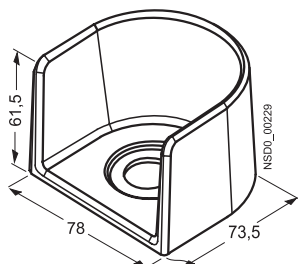

1) Can be used with a front plate thickness up to 4mm.

Holder for mounting 3 elements

Holder for pushbuttons

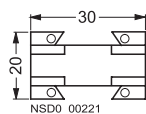

Holder for selector switch, key-operated switch and On-Off pushbutton, with pressure plate

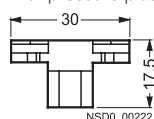

Push Button Units and Indicator Lights

SIRIUS 3SB3

Dimension drawings (mm) Accessories and enclosures

Enclosures

Enclosure without shroud, molded plastic

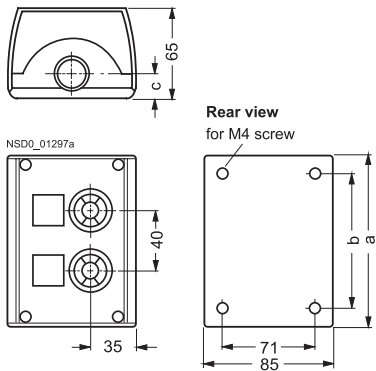

top and bottom with knockouts for one gland each

Number of command points	Length a	Spacing b	Spacing c
1	85	54	17,5
2	114	83	17,5
3	154	123	17,5
4	194	163	17,5
6	280	249	20,5

Enclosure without shroud, metal

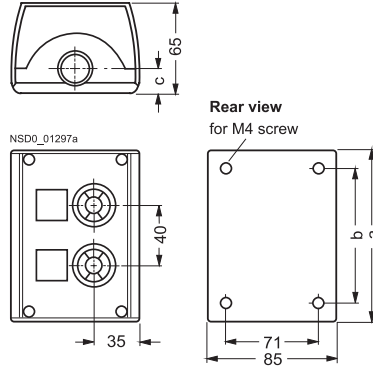

top and bottom with opening for one gland each

Number of command points	Length a	Spacing b	Spacing c
1	85	54	21
2	114	83	21
3	154	123	21
4	194	163	21
6	280	249	21

Enclosure with shroud, molded plastic

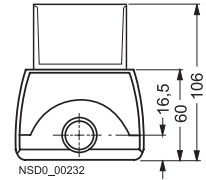

top and bottom with knockouts for one gland each

Enclosure with shroud, metal

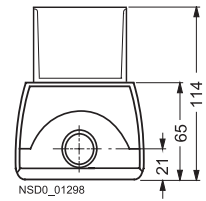

top and bottom with opening for one gland each

Screw connection, for base mounting

Contact block with 1 contact

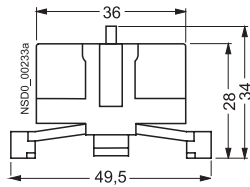

BA9s lampholder with or without integrated voltage reducer

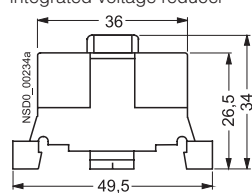

Lampholder with integrated LED

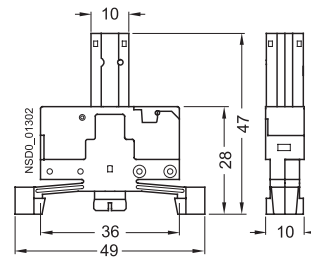

Spring-loaded terminals, for base mounting

Contact block with 1 contact

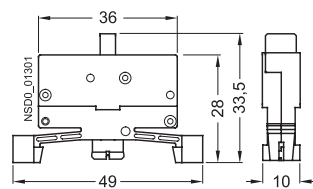

Lampholder with integrated LED

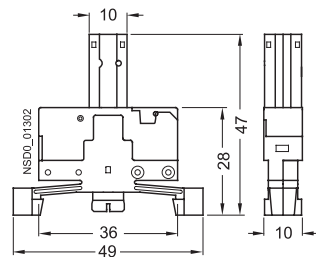

Support terminal

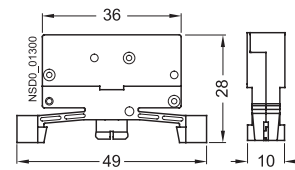

Typical circuits

3SB14 00-2N or 3SB34 00-1F lampholder
incl. 130 V incandescent lamp

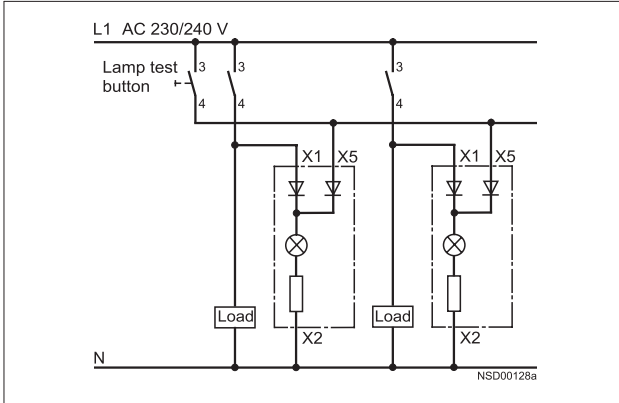

3SB14 00-2P or 3SB34 00-1G lampholder
for incandescent lamps up to 2.6 W or AC/DC LED lamps

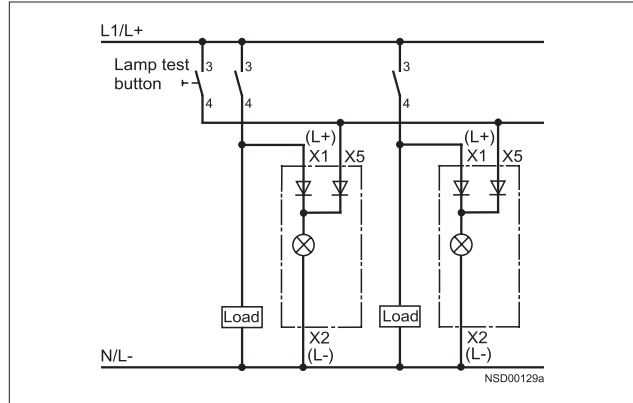

3SB14 00-2Q or 3SB34 00-1H lampholder
for incandescent lamp to 2.6 W or
AC neon bulbs or AC/DC LED lamps

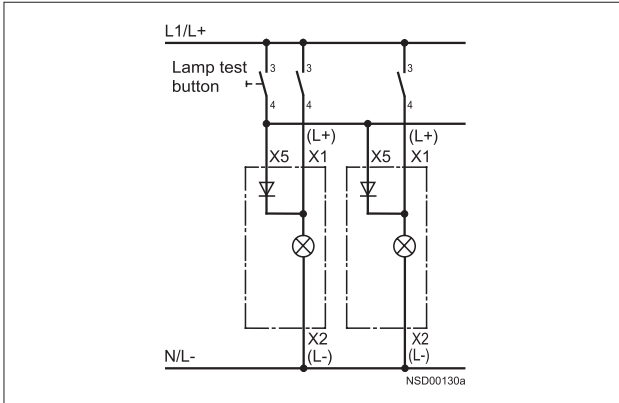

3SB34 00-1L lampholder
for incandescent lamp up to 2.6 W or
DC LED lamps

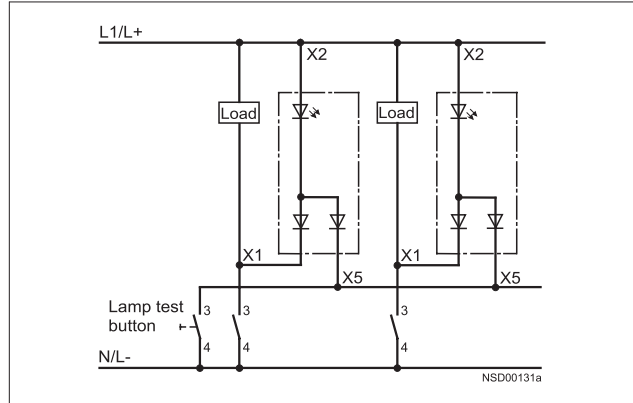

Typical lamp test circuit with
with 3SB14 00-3X or 3SB34 00-1N

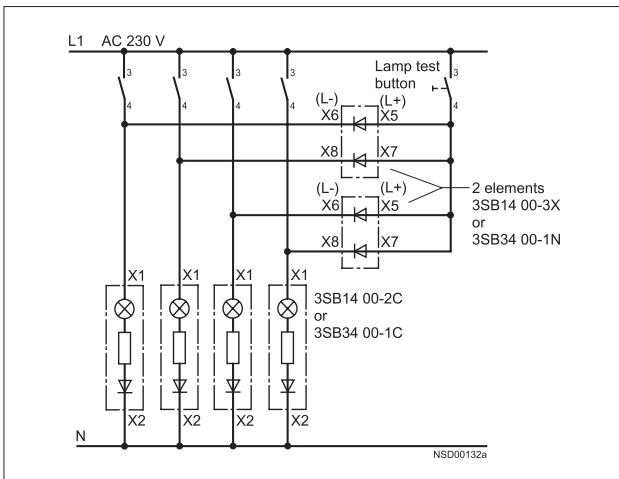

Application examples for 3SB14 00-3X and 3SB34 00-1N diode elements

- Lamp test circuit,
- Interference suppression,
- Limiting voltage peaks,
- Limiting DC coils,
- Diode gates,
- Rectifier circuits.

The diode element contains two 1N 4007 diodes. The element can be snapped onto the gear holder as required.

Notes on using the lampholders with separate lamp test function

When connected in parallel with inductive loads (e.g. contactors), surge suppression is required.

The 3SB14 00-2Q and 3SB34 00-1H elements are not suitable for use with a parallel load.

Example of a typical push to test circuit using a standard, illuminated push-button transformer type with 1 NO + 1 NC contact. e.g. Illuminated Pilot Light components require to make-up a 120 V red raised push to test transformer type use (1) each of the following components:

- 3SB3 001-0BA21
- 52AABN
- 3SB3 400-0B
- 3SB3 400-1A
- 3SB3 400-3M
- 3SB3 400-0C

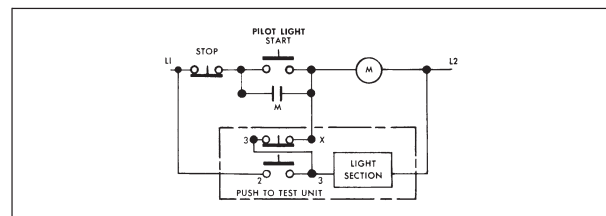

Push Button Units and Indicator Lights

3SE2, 3SE3 Foot Switches

Plastic and metal enclosures

Overview

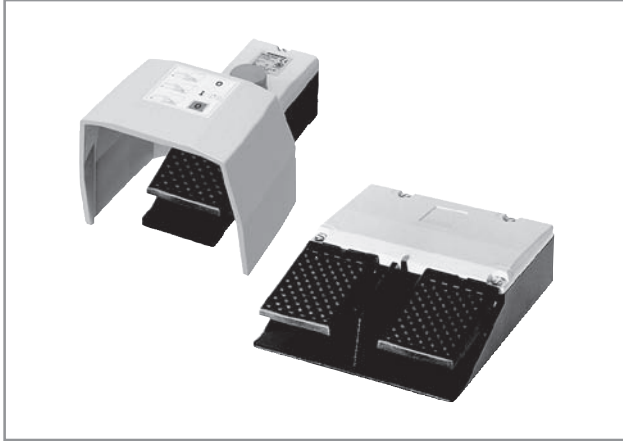

Foot switches with metal enclosures

Standard switches

The 3SE2 9 and 3SE3 9 foot switch range encompasses versions in a metal enclosure for rugged applications as well as versions with plastic enclosure for less harsh environments. The devices can be supplied with or without a cover and have fixing holes for them to be screwed to the floor.

Depending on the particular application, the metal enclosures can be ordered in latching or momentary-contact versions. The momentary-contact pedal switch in the plastic enclosure has one microswitch (changeover contact) per actuating pedal.

Safety foot switches

The 3SE2 924-3AA20 single-pedal safety foot switches are used on machines and plants as OK switches when operation by hand is not possible and the EMERGENCY-STOP function must be available if a hazardous status arises. The switches are interlocked according to EN ISO 13850 and bear the CE mark in accordance with the machinery directive.

The safety foot switches are protected by a guard hood against accidental operation.

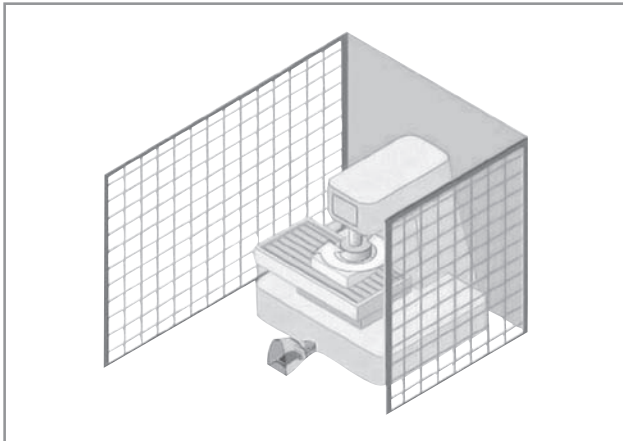

Application example

The switches have two contact blocks, each with one NO contact and one NC contact. The NO contacts and NC contacts of the two contact blocks are connected for easy connection of a single-phase motor. The normal workflow is initiated by pressing down the pedal as far as the pressure point so that the two NO contacts close and the motor starts to run.

If in the event of danger the pedal is pressed beyond the resistance of the pressure point, the positively driven NC contacts will open and the motor is stopped. At the same time the independent latching takes effect and holds the NC contacts in open position. This prevents the machine parts from continuing to run out of control or from being restarted.

After the hazard is eliminated, the machine can only be restarted after manually releasing the switch using a push button on the top of the enclosure. The contacts are then released again and return to their initial position (the NO contacts are open and the NC contacts are closed).

Technical specifications

Type	3SE29	3SE39
Metal and plastic enclosures		
Standards	IEC 60947-5-1	
Electrical load		
• At AC-15, 400 V		
- 1 NO + 1 NC	A 16	—
- 2 NO + 2 NC	A 6	—
- 3SE2 924-3AA20 (2 NO + 2 NC)	A 16	—
• At 250 V AC	A —	5
Short-circuit protection		
- 1 NO + 1 NC / 3SE2 924-3AA20	A 16 (slow)	—
- 2 NO + 2 NC	A 6 (slow)	—
- 1 CO contact	A —	5 (slow)
Mechanical endurance	> 10 ⁶ operating cycles	
Material		
• Enclosures	Aluminum casting	Impact-resistant thermoplast, self-extinguishing according to UL 94 VO
• Covers	Thermoplast	—
• Guard hoods	Aluminum casting	Metal
Degree of protection	IP65	IP65
Ambient temperature	°C -25 ... +80	-10 ... +75
Connection	Cable entry, metric	Cable AWG20, UL Style 2464, length 3 m

Push Button Units and Indicator Lights

3SE2, 3SE3 Foot Switches

Plastic and metal enclosures

1
2
3
4
5
6
7
8
9
10

Selection and ordering data

Version	Slow-action contacts for each pedal	DT	Order No.	PU (UNIT, SET, M)	PS		
Metal enclosures, degree of protection IP65							
 <p>3SE2 90.-AA20 3SE2 91.-AA20</p>	Momentary-contact foot switches, single pedal M20 x 1.5 cable entry						
	• Without hood	1 NO + 1 NC	⊙ A	3SE2 902-0AB20	1	1 unit	
		2 NO + 2 NC	⊙ A	3SE2 903-1AB20	1	1 unit	
	• With hood	1 NO + 1 NC	⊙ A	3SE2 902-0AA20	1	1 unit	
		2 NO + 2 NC	⊙ A	3SE2 903-1AA20	1	1 unit	
 <p>3SE2 912-2AB20 3SE2 912-2AA20</p>	Momentary-contact foot switches, single pedal M20 x 1.5 cable entry						
	• Without hood	1 NO + 1 NC	⊙ C	3SE2 912-2AB20	1	1 unit	
	• With hood	1 NO + 1 NC	⊙ C	3SE2 912-2AA20	1	1 unit	
	Momentary-contact foot switches, two pedals M25 x 1.5 cable entry						
 <p>3SE2 932-AB20 3SE2 932-AA20</p>	• Without hood	1 NO + 1 NC	⊙ B	3SE2 932-0AB20	1	1 unit	
		2 NO + 2 NC	⊙ B	3SE2 932-1AB20	1	1 unit	
	• With hood	1 NO + 1 NC	⊙ B	3SE2 932-0AA20	1	1 unit	
		2 NO + 2 NC	⊙ B	3SE2 932-1AA20	1	1 unit	
 <p>3SE2 924-3AA20</p>	Safety foot switches, single pedal, with hood, M20 x 1.5 cable entry, with interlock according to ISO 13850, NO closes as momentary contact type, NC opens with latching		2 NO + 2 NC	⊙ C	3SE2 924-3AA20	1	1 unit
	Plastic enclosures, degree of protection IP65						
 <p>3SE3 902-4CA20 3SE3 934-5CB20</p>	Momentary-contact pedal switches, 3 m cable						
	• Single pedal						
	- Without hood	1 CO contact	B	3SE3 902-4CB20	1	1 unit	
	1 CO contact	B	3SE3 902-4CA20	1	1 unit		
• Two pedals, without hood	2 x 1 CO	B	3SE3 934-5CB20	1	1 unit		

⊙ Positive opening according to IEC 60947-5-1, Appendix K.

Push Button Units and Indicator Lights

8WD4 Signaling Columns

General Data

Overview

The 8WD4 signaling columns are flexible in design and versatile in use.

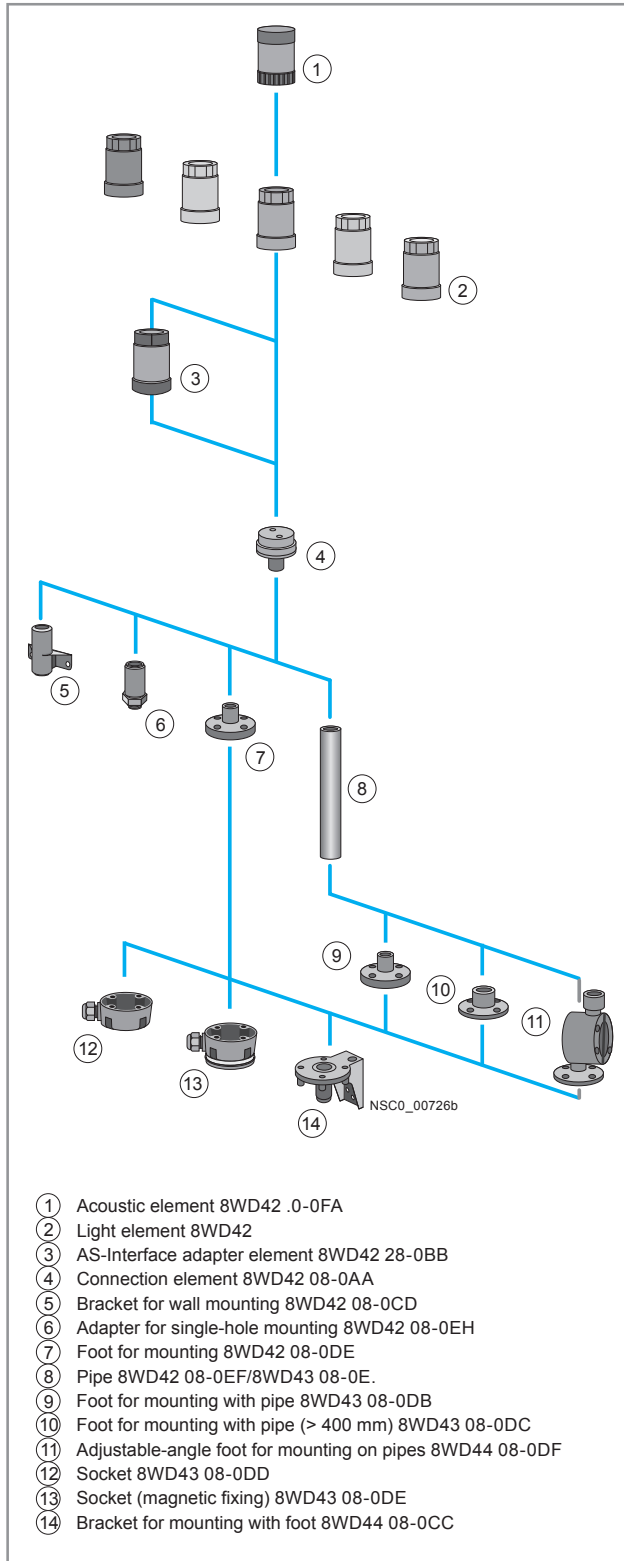

8WD42 signaling columns (width 50 mm) with up to 4 elements

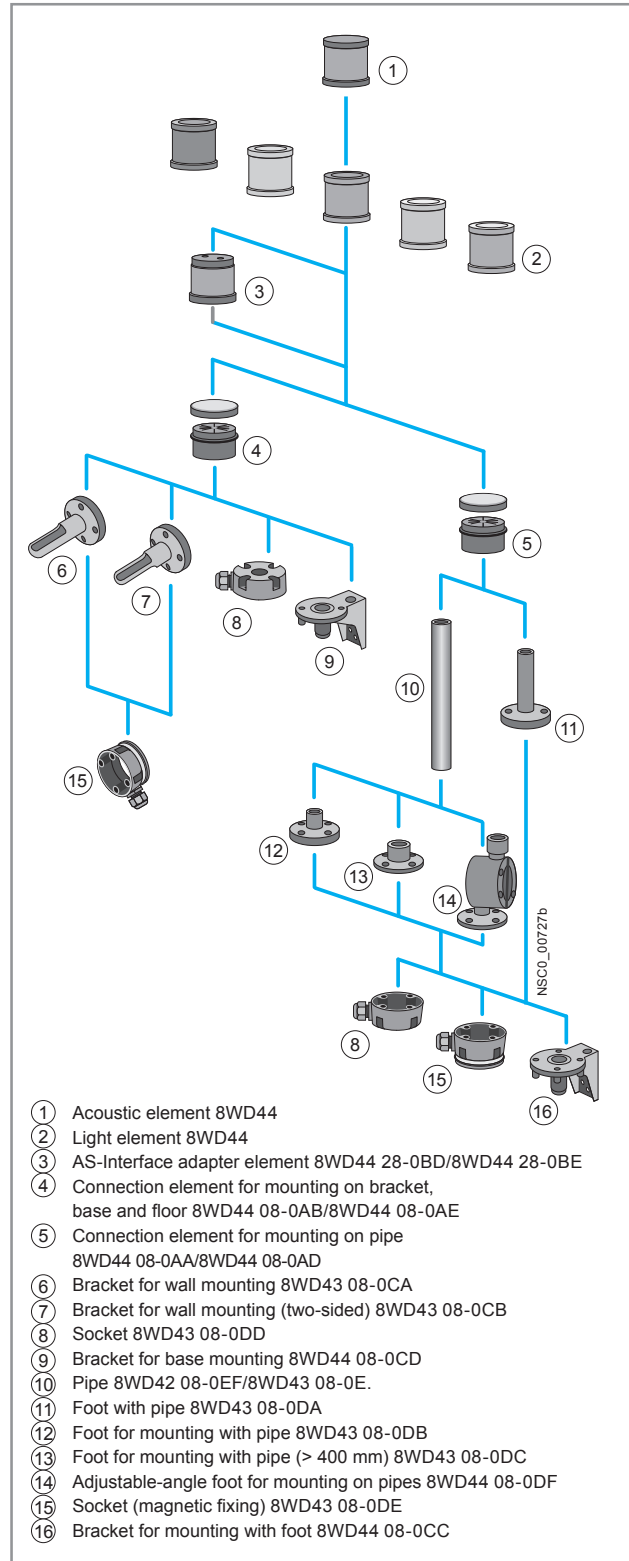

8WD44 signaling columns (width 70 mm) with up to 5 elements

Push Button Units and Indicator Lights

8WD4 Signaling Columns

General Data

1

2

3

4

5

6

7

8

9

10

Two product series are available:

- 8WD42
 - Thermoplast enclosure, diameter 50 mm
 - Degree of protection IP54
 - Up to 4 elements can be mounted between the connection element and the cover
- 8WD44
 - Thermoplast enclosure, diameter 70 mm
 - Advanced design and significantly improved illumination
 - Faster and more flexible connection using spring-type terminals
 - Integrated degree of protection IP65
 - Up to 5 elements can be mounted between the connection element and the cover



Signaling columns, mounting examples

The illustrated examples are from the left:

- 8WD42: Cover (no No.), 4 light elements ②, connection element ④, pipe ⑧, foot ⑨
- 8WD44: Acoustic element with integral cover ①, 2 light elements ②, connection element ⑤, foot with pipe ⑪
- 8WD44: Cover (no No.), 4 light elements ②, AS-Interface adapter element ③, connection element ④, bracket for wall mounting ⑥
- 8WD44: Cover (no No.), 3 light elements ②, AS-Interface adapter element ③, connection element ⑤, foot with pipe ⑪

Note:

The cover is supplied with the connection element; it is not needed with the acoustic element.

Benefits

- Choice of various light and acoustic elements with different functions: continuous light, blinklight, flashlight and rotating light; buzzer and siren
- Light elements with particularly long-lasting LEDs
- Variety of colors: red, yellow, green, white or blue
- Optimized illumination through improved prism technology with the 8WD44
- Acoustic elements can be adjusted in tone and volume
- Extremely resistant to shock and vibrations
- Easy connection and quick lamp change with secure bayonet mechanism
- Communication capability through connection to AS-Interface

Application

8WD4 signaling columns are used in machines or in automatic processes for monitoring complex procedures or as visual or acoustic warning devices in emergency situations, e.g. for displaying individual assembly stages.

Communication capability

Connection to AS-Interface

The 8WD4 signaling columns can be directly connected to the AS-Interface bus system through an adapter element that can be integrated in the column. Wiring outlay is reduced as the result. The two-wire bus cable is fixed to the terminals in the connection element. Up to four signaling elements can be mounted on it using an adapter element.

A/B technology enables the connection of up to 62 slaves on one AS-Interface system.

Connection

The signaling elements are wired up using the screw terminals in the connection element, screw terminals on the 8WD42 and screw or spring-type terminals on the 8WD44.

Cable outlet

The connecting cables can be guided either downwards or sideways through the cable gland using an adapter that can be screwed under the foot. This makes wiring easier if there is no access from below.

Connection to AS-Interface



8WD42:

The two-wire bus cable is fixed to the screw terminals in the connection element. The adapter element must be the first module to be mounted on the connection element. A maximum of 4 signaling elements can then be mounted on it.

The adapter element 8WD42 28-0BB is a standard slave.

8WD44:

The two-wire bus cable is fixed to the screw or spring-type terminals in the connection element. The adapter element must be the first module to be mounted on the connection element. The signaling elements can then be mounted on it.

The adapter element 8WD44 28-0BE is a standard slave. A maximum of 4 signaling elements can be mounted on it.

The adapter element 8WD44 28-0BD with A/B technology enables the connection of up to 62 slaves on one AS-Interface system. The addressing socket provides user-friendly parameterization of the AS-Interface elements. A maximum of 3 signaling elements can be mounted on it.

Push Button Units and Indicator Lights

8WD4 Signaling Columns

General Data

Technical specifications

Type	8WD42	8WD44
General data		
Approvals	UL, CSA	UL, CSA
Light and acoustic elements		
Rated voltage, power consumption		
Light elements with incandescent lamp	(AC values for 50/60 Hz)	(AC values for 50/60 Hz)
• Continuous light	12 V, 24 V, 115 V, 230 V AC/DC	12 V, 24 V, 115 V, 230 V AC/DC
• Blinklight	24 V AC/DC/125 mA; 115 V AC/20 mA; 230 V AC/15 mA	24 V AC/DC/125 mA; 115 V AC/20 mA; 230 V AC/15 mA
• Flashlights	—	24 V DC/125 mA; 115 V AC/20 mA; 230 V AC/35 mA
• Max. inrush current, blinklight/flashlight	—	500 mA
Light elements with integrated LED		
• Continuous light	24 V AC/DC/60 mA	24 V AC/DC/45 mA; 115 V AC/DC/25 mA; 230 V AC/25 mA
• Blinklight	—	24 V AC/DC/40 mA
• Rotating light	—	24 V AC/DC/70 mA
Acoustic elements		
• Buzzer element (tone: pulsating or continuous, 85 dB)	24 V AC/DC/25 mA; 115 V AC/DC/25 mA; 230 V AC/25 mA	24 V AC/DC/25 mA; 115 V AC/DC/25 mA; 230 V AC/25 mA
• Siren element (8 tones + amplification can be set, 100 dB)	—	24 V AC/DC/80 mA; 115 V AC/30 mA; 230 V AC/16 mA
• Siren element (108 dB)	—	24 V DC/100 mA
Power consumption		
• Incandescent lamps, base BA 15d	W	max. 5
• Flashlight, flash energy	Ws	—
		7
		2
Endurance		
• Flashlights	4 x 10 ⁶ flashes	4 x 10 ⁶ flashes
AS-Interface adapter elements		
IO code/ID code	8/F	8/E
Power supply		
• Operational voltage	V	Through bus cable
• Power consumption I_{max}	mA	18.5 ... 31.6
		50
		100
Protective measures		
• Watchdog	✓	✓
• Short-circuit/overload protection	External back-up fuse M 1.6 A	✓
• Reverse polarity protection	✓	✓
• Induction protection	N/A	✓
Outputs		
• Load voltage	V	4 Relay outputs
	V	External auxiliary voltage
		0 ... 30 DC
		0 ... 230 AC
• Current carrying capacity ΣI_{max}	A	1.5
- With external auxiliary voltage	A	—
- Without external auxiliary voltage	A	—
		0.3
		0.2
Operating temperature	°C	-20 ... +50
		-20 ... +50
Enclosures		
Enclosure material	Thermoplast (polyamide), impact-resistant, black	Thermoplast (polyamide), impact-resistant, black
Light elements	Thermoplast (polycarbonate)	Thermoplast (polycarbonate)
Mounting		
• Horizontal (floor mounting, foot with 25 mm Ø pipe)	✓	✓
• Horizontal (single-hole mounting)	✓	—
• Vertical with bracket	✓	✓
Degree of protection		
• Light elements	IP54	IP65 (seal premounted with every module)
• Acoustic elements, AS-i adapter elements	IP54	IP65
Operating temperature	°C	-20 ... +50
		-20 ... +50
Connection		
• Conductor cross-sections	mm ²	M3 screw terminal
• Tightening torque	Nm	Max. 2.5
		Max. 0.5
		Spring-type terminals/M3 screw terminals
		Max. 2.5
		- / Max. 0.5

Push Button Units and Indicator Lights

8WD4 Signaling Columns

8WD42 signaling columns, 50 mm diameter

1
2
3
4
5
6
7
8
9
10

Overview

Features:

- Thermoplast enclosure, diameter 50 mm
- Degree of protection IP54
- Up to 4 elements can be mounted

Selection and ordering data

Version	Rated voltage	Color	DT	Order No.	PU (UNIT, SET, M)	PS	PG
V							
Acoustic elements¹⁾							
	Buzzer elements 80 dB, pulsating or continuous tone, adjustable by means of a wire jumper	24 AC/DC	Black	A	8WD42 20-0FA	1	1 unit 41J
		115 AC		A	8WD42 40-0FA	1	1 unit 41J
		230 AC		A	8WD42 50-0FA	1	1 unit 41J
Light elements for incandescent lamps/LEDs, BA 15d bases²⁾							
	Continuous light elements	24 ... 230 AC/DC	Red	A	8WD42 00-1AB	1	1 unit 41J
			Green	A	8WD42 00-1AC	1	1 unit 41J
			Yellow	A	8WD42 00-1AD	1	1 unit 41J
			Clear	A	8WD42 00-1AE	1	1 unit 41J
			Blue	A	8WD42 00-1AF	1	1 unit 41J
Light elements with integrated LED							
	Continuous light elements	24 AC/DC	Red	A	8WD42 20-5AB	1	1 unit 41J
			Green	A	8WD42 20-5AC	1	1 unit 41J
			Yellow	A	8WD42 20-5AD	1	1 unit 41J
			Clear	X	8WD42 20-5AE	1	1 unit 41J
			Blue	X	8WD42 20-5AF	1	1 unit 41J
	Blinklight elements	24 AC/DC	Red	A	8WD42 20-5BB	1	1 unit 41J
			Green	A	8WD42 20-5BC	1	1 unit 41J
			Yellow	A	8WD42 20-5BD	1	1 unit 41J
			Clear	A	8WD42 20-5BE	1	1 unit 41J
			Blue	A	8WD42 20-5BF	1	1 unit 41J
			115 AC	Red	A	8WD42 40-5BB	1
		Green		A	8WD42 40-5BC	1	1 unit 41J
		Yellow		A	8WD42 40-5BD	1	1 unit 41J
		230 AC	Clear	D	8WD42 40-5BE	1	1 unit 41J
			Blue	D	8WD42 40-5BF	1	1 unit 41J
			Red	A	8WD42 50-5BB	1	1 unit 41J
			Green	A	8WD42 50-5BC	1	1 unit 41J
			Yellow	A	8WD42 50-5BD	1	1 unit 41J
			Clear	A	8WD42 50-5BE	1	1 unit 41J
			AS-Interface adapter elements with external auxiliary voltage	For 4 signaling elements 24 V DC	Black	A	8WD42 28-0BB
							
Connection elements³⁾							
	Connection elements with cover For mounting on pipes, floors and angles		Black	A	8WD42 08-0AA	1	1 unit 41J

¹⁾ One acoustic element can be mounted per signaling column. The cover is included in the scope of supply of the acoustic elements and fixed in place.

²⁾ The lamp is not included in the scope of supply. Please order separately.

³⁾ The connection element with cover is an essential part for assembling the signaling columns.

Note:

For mounting and configuring aid see the publication "Versatile, robust, communication-capable: SIRIUS signaling columns and integrated signal lamps", Order No. E20001-A670-P305.

Push Button Units and Indicator Lights

8WD4 Signaling Columns

8WD42 signaling columns, 50 mm diameter

Version	Rated voltage	Color	DT	Order No.	PU (UNIT, SET, M)	PS	
V							
Lamps							
	Incandescent lamps, 5 W						
	Base BA 15d	24 AC/DC	A	8WD43 28-1XX	1	10 units	
		115 AC	A	8WD43 48-1XX	1	10 units	
		230 AC	A	8WD43 58-1XX	1	10 units	
	LEDs						
	Base BA 15d	24 AC/DC	Red	A	8WD44 28-6XB	1	1 unit
			Green	A	8WD44 28-6XC	1	1 unit
			Yellow	A	8WD44 28-6XD	1	1 unit
			Clear	A	8WD44 28-6XE	1	1 unit
			Blue	A	8WD44 28-6XF	1	1 unit
		115 AC	Red	A	8WD44 48-6XB	1	1 unit
			Green	A	8WD44 48-6XC	1	1 unit
			Yellow	A	8WD44 48-6XD	1	1 unit
			Clear	A	8WD44 48-6XE	1	1 unit
			Blue	A	8WD44 48-6XF	1	1 unit
		230 AC	Red	A	8WD44 58-6XB	1	1 unit
			Green	A	8WD44 58-6XC	1	1 unit
			Yellow	A	8WD44 58-6XD	1	1 unit
			Clear	A	8WD44 58-6XE	1	1 unit
		Blue	A	8WD44 58-6XF	1	1 unit	
Mounting							
	Feet, single						
		Plastic, for mounting on pipes	A	8WD43 08-0DB	1	1 unit	
		Metal, for pipe lengths > 400 mm	A	8WD43 08-0DC	1	1 unit	
		Plastic, for floor mounting (without pipe)	A	8WD42 08-0DE	1	1 unit	
	Adjustable-angle feet for positioning in 7.5° increments ¹⁾						
		Plastic, for mounting on pipes, incl. rubber seal	X	8WD44 08-0DF	1	1 unit	
	Pipes, single						
	Length	100 mm	A	8WD42 08-0EF	1	1 unit	
	Length	150 mm	A	8WD43 08-0EE	1	1 unit	
	Length	250 mm	A	8WD43 08-0EA	1	1 unit	
	Length	400 mm	A	8WD43 08-0EB	1	1 unit	
	Length	1000 mm	A	8WD43 08-0ED	1	1 unit	
	Sockets for feet						
		Side cable outlet	A	8WD43 08-0DD	1	1 unit	
		Side cable outlet, with magnetic fixing ²⁾	A	8WD43 08-0DE	1	1 unit	
	Brackets for mounting with foot						
			A	8WD44 08-0CC	1	1 unit	
	Brackets for wall mounting (plastic)						
	Mounting without feet and pipe	A	8WD42 08-0CD	1	1 unit		
	Adapters for single-hole mounting						
	Mounting without feet and pipe, with M18 thread and fixing nut	A	8WD42 08-0EH	1	1 unit		

For labeling panels see 8WD44, page 10/118.

¹⁾ Markings for 30°, 45°, 60° and 90°.

²⁾ For horizontal mounting, only 1 element is recommended.

Push Button Units and Indicator Lights

8WD4 Signaling Columns

8WD44 signaling columns, 70 mm diameter



1
2
3
4
5
6
7
8
9
10

Overview

Features:

- Thermoplast enclosure, diameter 70 mm
- Advanced design and significantly improved illumination
- Fast and flexible connection using spring-type terminals
- Integrated degree of protection IP65
- Up to 5 elements can be mounted

Selection and ordering data

Version	Rated voltage	Color	DT	Order No.	PU (UNIT, SET, M)	PS		
	V							
Acoustic elements¹⁾								
	Buzzer elements 85 dB, pulsating or continuous tone, adjustable by means of a wire jumper	24 AC/DC	Black	A	8WD44 20-0FA	1	1 unit	
		115 AC		A	8WD44 40-0FA	1	1 unit	
		230 AC		A	8WD44 50-0FA	1	1 unit	
	Siren elements , multi-tone, 100 dB, 8 tones and volume are adjustable	24 AC/DC	Black	A	8WD44 20-0EA2	1	1 unit	
		115 AC		A	8WD44 40-0EA2	1	1 unit	
		230 AC		A	8WD44 50-0EA2	1	1 unit	
	Siren elements 108 dB, IP40	24 DC	Black	A	8WD44 20-0EA	1	1 unit	
	Light elements for incandescent lamps/LEDs, BA 15d bases²⁾							
		Continuous light elements	12 ... 230 AC/DC	Red	A	8WD44 00-1AB	1	1 unit
			Green	A	8WD44 00-1AC	1	1 unit	
			Yellow	A	8WD44 00-1AD	1	1 unit	
			Clear	A	8WD44 00-1AE	1	1 unit	
			Blue	A	8WD44 00-1AF	1	1 unit	
Blinklight elements		24 AC/DC		Red	A	8WD44 20-1BB	1	1 unit
				Green	A	8WD44 20-1BC	1	1 unit
				Yellow	A	8WD44 20-1BD	1	1 unit
				Clear	A	8WD44 20-1BE	1	1 unit
				Blue	A	8WD44 20-1BF	1	1 unit
		115 AC		Red	A	8WD44 40-1BB	1	1 unit
				Green	A	8WD44 40-1BC	1	1 unit
				Yellow	A	8WD44 40-1BD	1	1 unit
				Clear	A	8WD44 40-1BE	1	1 unit
				Blue	A	8WD44 40-1BF	1	1 unit
		230 AC		Red	A	8WD44 50-1BB	1	1 unit
				Green	A	8WD44 50-1BC	1	1 unit
				Yellow	A	8WD44 50-1BD	1	1 unit
				Clear	A	8WD44 50-1BE	1	1 unit
				Blue	A	8WD44 50-1BF	1	1 unit
Light elements with integrated flash lamps³⁾								
	Flashlight elements with integrated electronic flash	24 DC	Red	A	8WD44 20-0CB	1	1 unit	
			Green	A	8WD44 20-0CC	1	1 unit	
			Yellow	A	8WD44 20-0CD	1	1 unit	
			Clear	A	8WD44 20-0CE	1	1 unit	
			Blue	A	8WD44 20-0CF	1	1 unit	
	115 AC		Red	A	8WD44 40-0CB	1	1 unit	
			Green	D	8WD44 40-0CC	1	1 unit	
			Yellow	A	8WD44 40-0CD	1	1 unit	
			Clear	D	8WD44 40-0CE	1	1 unit	
			Blue	D	8WD44 40-0CF	1	1 unit	
	230 AC		Red	A	8WD44 50-0CB	1	1 unit	
			Green	A	8WD44 50-0CC	1	1 unit	
			Yellow	A	8WD44 50-0CD	1	1 unit	
			Clear	A	8WD44 50-0CE	1	1 unit	
			Blue	A	8WD44 50-0CF	1	1 unit	

¹⁾ One acoustic element can be mounted per signaling column. The cover is included in the scope of supply of the acoustic elements and fixed in place.







²⁾ The lamp is not included in the scope of supply. Please order separately.

³⁾ The lamp is included in the scope of supply.

Push Button Units and Indicator Lights

8WD4 Signaling Columns

8WD44 signaling columns, 70 mm diameter

Version	Rated voltage	Color	DT	Order No.	PU (UNIT, SET, M)	PS								
V														
Light elements with integrated LED														
	Continuous light elements	24 AC/DC	Red	A	8WD44 20-5AB	1	1 unit							
			Green	A	8WD44 20-5AC	1	1 unit							
			Yellow	A	8WD44 20-5AD	1	1 unit							
			Clear	A	8WD44 20-5AE	1	1 unit							
			Blue	A	8WD44 20-5AF	1	1 unit							
		115 AC	Red	A	8WD44 40-5AB	1	1 unit							
			Green	A	8WD44 40-5AC	1	1 unit							
			Yellow	A	8WD44 40-5AD	1	1 unit							
			Clear	A	8WD44 40-5AE	1	1 unit							
			Blue	A	8WD44 40-5AF	1	1 unit							
		230 AC	Red	A	8WD44 50-5AB	1	1 unit							
			Green	A	8WD44 50-5AC	1	1 unit							
			Yellow	A	8WD44 50-5AD	1	1 unit							
			Clear	A	8WD44 50-5AE	1	1 unit							
			Blue	A	8WD44 50-5AF	1	1 unit							
	Blinklight elements	24 AC/DC	Red	A	8WD44 20-5BB	1	1 unit							
			Green	A	8WD44 20-5BC	1	1 unit							
			Yellow	A	8WD44 20-5BD	1	1 unit							
			Clear	X	8WD44 20-5BE	1	1 unit							
			Blue	A	8WD44 20-5BF	1	1 unit							
		115 AC	Red	A	8WD44 40-5BB	1	1 unit							
			Green	A	8WD44 40-5BC	1	1 unit							
			Yellow	A	8WD44 40-5BD	1	1 unit							
			Clear	A	8WD44 40-5BE	1	1 unit							
			Blue	A	8WD44 40-5BF	1	1 unit							
		230 AC	Red	A	8WD44 50-5BB	1	1 unit							
			Green	A	8WD44 50-5BC	1	1 unit							
			Yellow	A	8WD44 50-5BD	1	1 unit							
			Clear	A	8WD44 50-5BE	1	1 unit							
			Blue	A	8WD44 50-5BF	1	1 unit							
	Rotating light elements	24 AC/DC	Red	A	8WD44 20-5DB	1	1 unit							
			Green	A	8WD44 20-5DC	1	1 unit							
			Yellow	A	8WD44 20-5DD	1	1 unit							
Adapter elements for AS-Interface														
	AS-Interface adapter elements With/without external auxiliary voltage, switchable													
								• A/B technology	For 3 signaling elements 24 V DC	Black	A	8WD44 28-0BD	1	1 unit
								• Standard AS-i	For 4 signaling elements 24 V DC	Black	A	8WD44 28-0BE	1	1 unit
Connection elements¹⁾														
	Connection elements with cover													
								Screw terminals	Black					
								• For mounting on pipes						
								• For mounting on brackets and floors	A	8WD44 08-0AB	1	1 unit		
								Spring-type terminals	Black					
								• For mounting on pipes						
• For mounting on brackets and floors	A	8WD44 08-0AE	1	1 unit										
Cover (replacement)	A	8WD44 08-0XA	1	1 unit										









¹⁾ The connection element with cover is an essential part for assembling the signaling columns.

Push Button Units and Indicator Lights

8WD4 Signaling Columns

8WD44 signaling columns, 70 mm diameter

1
2
3
4
5
6
7
8
9
10

Version	DT	Order No.	PU (UNIT, SET, M)	PS		
Mounting						
	Foot with pipe	Pipe length 100 mm	A	8WD43 08-0DA	1	1 unit
	Feet, single	Plastic, for mounting on pipes	A	8WD43 08-0DB	1	1 unit
		Metal, for pipe lengths > 400 mm	A	8WD43 08-0DC	1	1 unit
	Adjustable-angle feet for positioning in 7.5° increments ¹⁾	Plastic, for mounting on pipes, incl. rubber seal	X	8WD44 08-0DF	1	1 unit
	Pipes, single	Length 100 mm	A	8WD42 08-0EF	1	1 unit
		Length 150 mm	A	8WD43 08-0EE	1	1 unit
		Length 250 mm	A	8WD43 08-0EA	1	1 unit
		Length 400 mm	A	8WD43 08-0EB	1	1 unit
		Length 1000 mm	A	8WD43 08-0ED	1	1 unit
	Sockets for feet	Side cable outlet (can also be used without feet)	A	8WD43 08-0DD	1	1 unit
		Side cable outlet, with magnetic fixing ²⁾	A	8WD43 08-0DE	1	1 unit
	Brackets for wall mounting (mounting without feet and pipe)	For single-sided mounting	A	8WD43 08-0CA	1	1 unit
		For double-sided mounting	A	8WD43 08-0CB	1	1 unit
	Brackets for mounting with foot		A	8WD44 08-0CC	1	1 unit
	Brackets for base mounting	Mounting without feet and pipe	A	8WD44 08-0CD	1	1 unit
	Adapter for mounting on pipes according to NPT	Mounting on pipes, Ø 25 mm, with NPT 1/2" thread	A	8WD43 08-0DF	1	1 unit

¹⁾ Markings for 30°, 45°, 60° and 90°.

²⁾ For horizontal mounting, only 1 element is recommended.



Note:

For mounting and configuring aid see the publication "Versatile, robust, communication-capable: SIRIUS signaling columns and integrated signal lamps", Order No. E20001-A670-P305.

Push Button Units and Indicator Lights

8WD4 Signaling Columns

8WD44 signaling columns, 70 mm diameter

Version	Rated voltage	Color	DT	Order No.	PU (UNIT, SET, M)	PS	
V							
Lamps							
	Incandescent lamps, 5 W						
	Base BA 15d	24 AC/DC	A	8WD43 28-1XX	1	10 units	
		115 AC	A	8WD43 48-1XX	1	10 units	
		230 AC	A	8WD43 58-1XX	1	10 units	
	LEDs						
	Base BA 15d	24 AC/DC	Red	A	8WD44 28-6XB	1	1 unit
			Green	A	8WD44 28-6XC	1	1 unit
			Yellow	A	8WD44 28-6XD	1	1 unit
			Clear	A	8WD44 28-6XE	1	1 unit
			Blue	A	8WD44 28-6XF	1	1 unit
		115 AC	Red	A	8WD44 48-6XB	1	1 unit
			Green	A	8WD44 48-6XC	1	1 unit
			Yellow	A	8WD44 48-6XD	1	1 unit
			Clear	A	8WD44 48-6XE	1	1 unit
			Blue	A	8WD44 48-6XF	1	1 unit
		230 AC	Red	A	8WD44 58-6XB	1	1 unit
			Green	A	8WD44 58-6XC	1	1 unit
			Yellow	A	8WD44 58-6XD	1	1 unit
			Clear	A	8WD44 58-6XE	1	1 unit
		Blue	A	8WD44 58-6XF	1	1 unit	
Inscriptions							
	Labeling panels		A	8WD44 08-0FA	1	1 unit	
<p>With fixing accessories for mounting on pipe \varnothing 25 mm</p> <p>Inscription area/ step 50 mm x 140 mm</p> <p>Suitable for standard labels, e.g.</p> <ul style="list-style-type: none"> • Zweckform 3425 • Herma 4457 							

Overview



Integrated signal lamps

Design

Features:

- Thermoplast enclosures, diameter 70 mm
- Degree of protection IP65
- Rated voltage 24 V, 115 V, 230 V AC/DC
- Ambient temperature -20 to +50 °C, incandescent lamp up to 60 °C

The special shape of the integrated signal lamps means that the light is emitted optimally in every direction (to the sides and upwards). Continuous lights (with incandescent lamp or LED) and single-flash lights are available in five colors.

The LED versions of the integrated signal lamps offer a considerably longer endurance than the incandescent lamp versions.

All integrated signal lamps have a high degree of protection IP65 and are made of a material highly resistant to impact.

Mounting

8WD53 integrated signal lamps can be mounted directly at any point of the machine for the purpose of giving visual signals. They are mounted by means of a PG29 screw base with nut.

Selection and ordering data

Version	Rated voltage	Color	DT	Order No.	Price per PU	PU (UNIT, SET, M)	PS	PG	
V									
Luminaires for incandescent lamps/LED, BA 15d base									
	Continuous light¹⁾	12 ... 230 AC/DC	Red	A	8WD53 00-1AB		1	1 unit	41J
			Green	A	8WD53 00-1AC		1	1 unit	41J
			Yellow	A	8WD53 00-1AD		1	1 unit	41J
			Clear	A	8WD53 00-1AE		1	1 unit	41J
			Blue	A	8WD53 00-1AF		1	1 unit	41J
Luminaires with integrated flash lamp									
	Single-flash light with integrated electronic flash	24 AC/DC	Red	A	8WD53 20-0CB		1	1 unit	41J
			Green	D	8WD53 20-0CC		1	1 unit	41J
			Yellow	A	8WD53 20-0CD		1	1 unit	41J
			Clear	A	8WD53 20-0CE		1	1 unit	41J
			Blue	A	8WD53 20-0CF		1	1 unit	41J
		115 AC	Red	A	8WD53 40-0CB		1	1 unit	41J
			Green	D	8WD53 40-0CC		1	1 unit	41J
			Yellow	D	8WD53 40-0CD		1	1 unit	41J
			Clear	D	8WD53 40-0CE		1	1 unit	41J
			Blue	D	8WD53 40-0CF		1	1 unit	41J
		230 AC	Red	A	8WD53 50-0CB		1	1 unit	41J
			Green	D	8WD53 50-0CC		1	1 unit	41J
Yellow	A		8WD53 50-0CD		1	1 unit	41J		
Clear	A		8WD53 50-0CE		1	1 unit	41J		
Blue	D		8WD53 50-0CF		1	1 unit	41J		
Luminaires with integrated LED									
	Continuous light	24 AC/DC	Red	A	8WD53 20-5AB		1	1 unit	41J
			Green	A	8WD53 20-5AC		1	1 unit	41J
			Yellow	A	8WD53 20-5AD		1	1 unit	41J
	Blinklight lamps	24 AC/DC	Red	A	8WD53 20-5BB		1	1 unit	41J
			Green	D	8WD53 20-5BC		1	1 unit	41J
			Yellow	A	8WD53 20-5BD		1	1 unit	41J
	Rotating light	24 AC/DC	Red	A	8WD53 20-5DB		1	1 unit	41J
			Green	A	8WD53 20-5DC		1	1 unit	41J
			Yellow	A	8WD53 20-5DD		1	1 unit	41J

For incandescent lamps and LEDs see "Signaling Columns" page 10/118

¹⁾ Lamp not included in scope of supply. Please order separately.

Push Button Units and Indicator Lights

8WD4 Signaling Columns

Dimension drawings

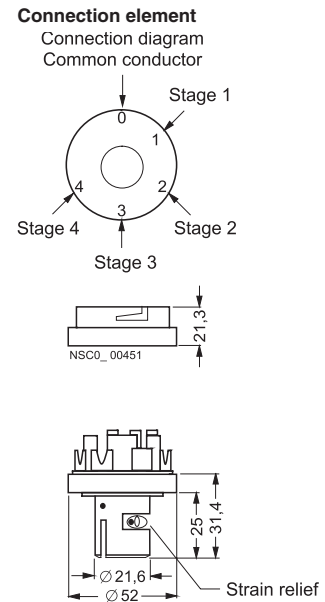
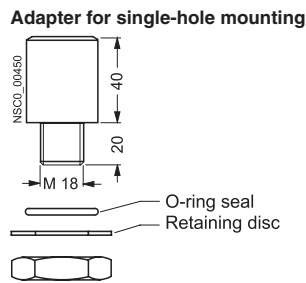
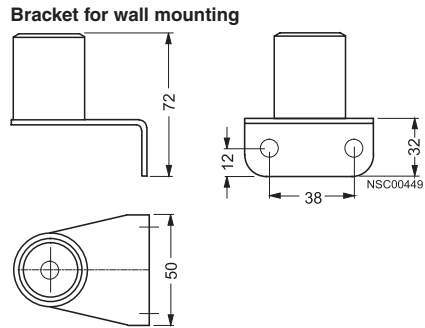
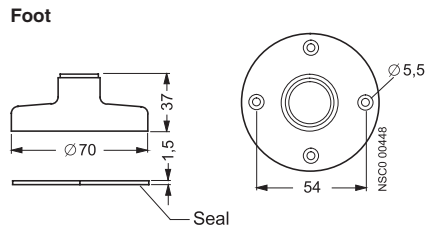
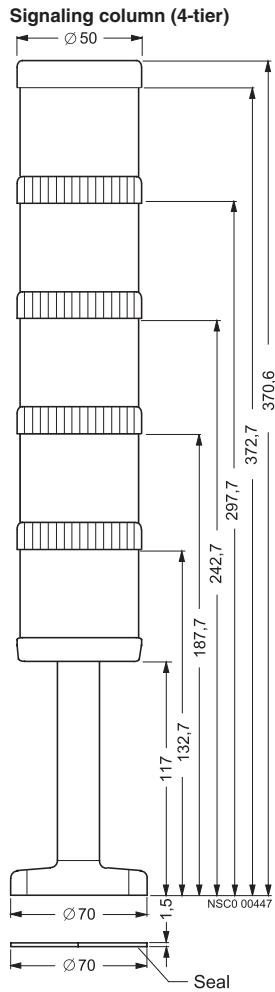

Dimension drawings

Signaling column (5-tier)

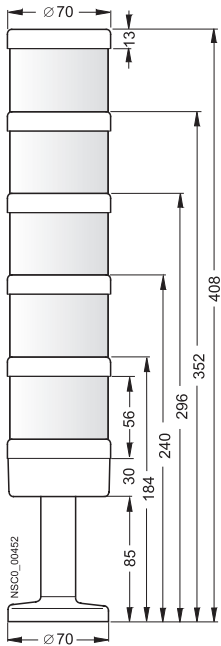

Connection diagrams

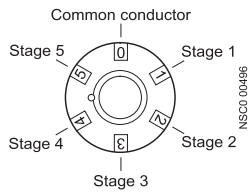

conventional

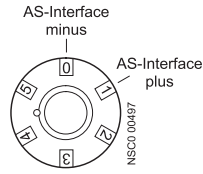

with AS-Interface,
without external auxiliary
voltage

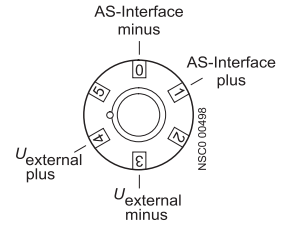

with external auxiliary voltage

Connection element and cover for mounting on pipes

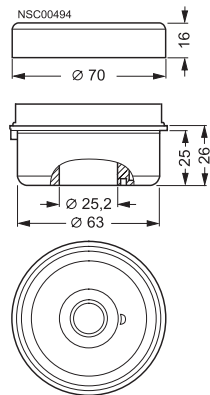

Connection element and cover for mounting on floor/bracket

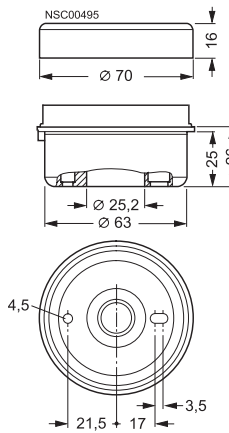

Foot with pipe

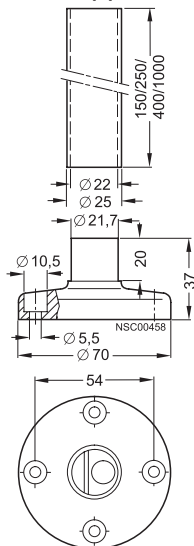

Bracket for single-sided mounting

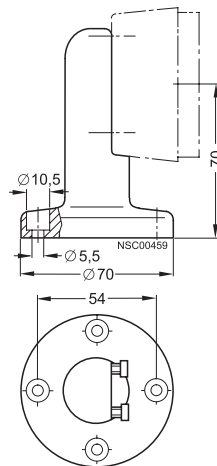

Bracket for double-sided mounting

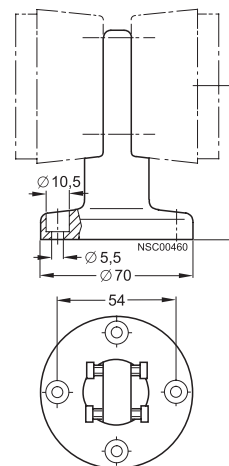

Push Button Units and Indicator Lights

8WD53 Beacons

Dimension drawings

Dimension drawings

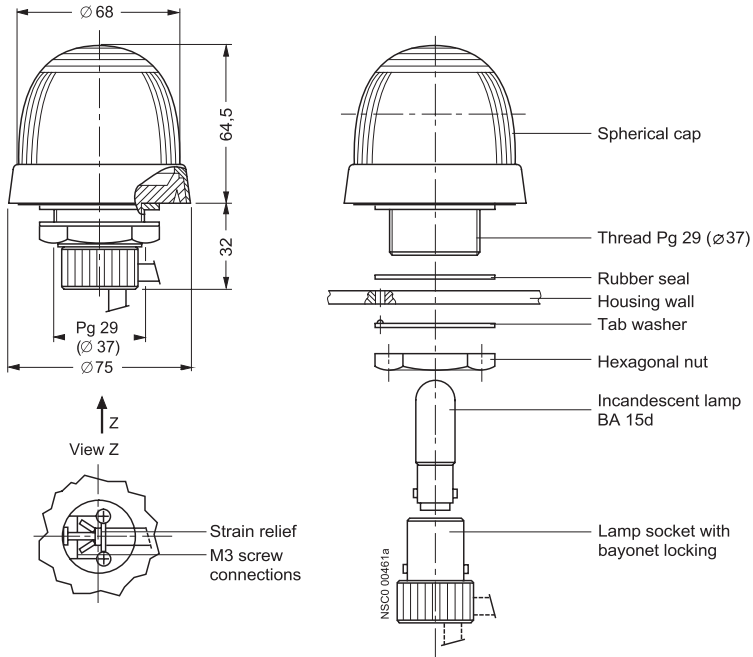

Pushbutton Units and Indicator Lights

Class 50 Standard Duty Pushbutton Stations

General

Features

- Snap In Legend Inserts
- Flush and Surface Mounted Types
- Convertible Selector
- Double Break Contacts
- Dual Voltage Pilot Light with Snap In Lens
- Conversion Kits
- UL Listed File #E22655
- CSA Certified File #LR6535

Application

Standard duty control stations are used with magnetic controllers to control the starting, stopping, reversing or speed of applicable motors.

Stations are assembled of one, two or three push button, selector switch or pilot light units in a variety of combinations to provide compact control units for remote control of magnetic starters and contactors.

Station enclosures are available in Type 1 surface mounted, 1B flush plate mounted and 4 watertight.

Features

Type 1 surface mounted bases are constructed of 14 gauge sheet steel, primed and finished in baked gray enamel. The base is predrilled to receive a variety of contact blocks, pilot lights and accessory devices. Covers are of 20 gauge sheet steel, wrap-around construction, primed and finished in baked gray enamel. Siemens Type 4 watertight heavy duty push button stations are supplied with a provision to padlock the stop button in the depressed position. Enclosures are predrilled and tapped for 3/4" conduit.

Contact blocks have double break, fine silver contacts with a NEMA B600 rating. Type 4 stations have a NEMA A600 rating.

The pilot light assembly is dual voltage with clearly marked pressure type terminals for 120 volt or 240 volt connection.

The lens of the pilot light snaps into the cover and is available in both red and green.

Push buttons are equipped with an operator into which a selected legend insert is snapped. Legend inserts are molded thermoplastic and come in a wide variety of legends and colors.

The selector switch operator can be instantly set for two or three positions at any time.

Mushroom Head

50ZMH mounts on any standard push button operator. The Mushroom Head is red molded thermoplastic, 1 1/2" in diameter, and provides a large operator for emergency stop or similar applications.

Mechanical Interlock

50ZAM is a base mounted zinc plate, dichromate dipped, steel assembly. When mounted in conjunction with Duplex Contact Block 50ZAC3 (one NO and one NO) the interlock prevents one contact from being closed while the other contact is closed.

Padlock Attachment Kit

50ZAL can be mounted to any Type 1 surface mounted station by the lower screw which fastens the cover to the station base. Made of heavy steel, chrome plated, the attachment provides for the padlocking of a push button in the depressed position or a selector switch in any position. When used with a push button operator, raised Legend Insert D53493003 (Red Stop) must be used.

Electrical Ratings

NEMA AC Ratings 50/60Hz

Nema B600 5 Continuous Amps

Volts	Make	Break
120	30	3
240	15	1.5
480	7.5	0.75
600	6	0.6
VA	3600	360

Ordering Information

- Legend Inserts [see page 10/130](#).
- Accessories [see page 10/130](#).



**2 Push Buttons
Surface Mounting, NEMA 1**



**2 Push Buttons
Flush Mounting, NEMA 1B**



**1 Push Button
Surface Mounting**



**1 Selector Switch
Flush Mounting**



**2 Push Buttons
1 Selector Switch**





**1 Pilot Light
2 Push Buttons**

Pushbutton Units and Indicator Lights

Class 50 Standard Duty Pushbutton Stations

5A 600V AC NEMA B600

Selection and ordering data

	Operator identification	Degree of protection	Contacts / voltage	Number of command points	Order No.	Packs
						Unit
 <p>1 unit surface mount-momentary pushbutton</p>	A = Momentary flush pushbutton green, surface, label "START"	NEMA 1	1NO - 1NC with common jumper (50ZAC1)	1	50AA3D	1
	A = Momentary flush pushbutton red, surface, label "STOP"	NEMA 1	1NO - 1NC with common jumper (50ZAC1)	1	50AA3E	1
	A = Momentary raised pushbutton red, surface, label "STOP"	NEMA 1	1NO - 1NC with common jumper (50ZAC1)	1	50AA3F	1
	A = Momentary mushroom head red, surface, label "STOP"	NEMA 1	1NO - 1NC with common jumper (50ZAC1)	1	50AA3G	1
	A = Momentary flush pushbutton less insert, surface	NEMA 1	1NO - 1NC with common jumper (50ZAC1)	1	50AA3A	1
	A = 3 position selector switch, surface, label "HAND-OFF-AUTO"	NEMA 1	2 NO 2SPST (50ZAC8)	1	50AA3C3	1
	A = 2 position selector switch, surface, label "Off-On"	NEMA 1	2 NO 2SPST (50ZAC8)	1	50AA3C6	1
	A = 2/3 selector switch, surface, multiple legends	NEMA 1	2 NO 2SPST (50ZAC8)	1	50AA3B9	1
	A = Indicator light, red, surface	NEMA 1	120/240V dual voltage 120PSB lamp	1	50BA3Y	1
	A = Indicator light, green, surface	NEMA 1	120/240V dual voltage 120PSB lamp	1	50BA3Z	1
	A = Indicator light, less lens, surface	NEMA 1	120/240V dual voltage 120PSB lamp	1	50BA32	1
	A = Momentary flush pushbutton green, flush, label "START"	NEMA 1B	1NO - 1NC with common jumper (50ZAC1)	1	50AA2D	1
 <p>1 unit flush mount-momentary pushbutton</p>	A = Momentary flush pushbutton red, flush, label "STOP"	NEMA 1B	1NO - 1NC with common jumper (50ZAC1)	1	50AA2E	1
	A = Momentary raised pushbutton red, flush, label "STOP"	NEMA 1B	1NO - 1NC with common jumper (50ZAC1)	1	50AA2F	1
	A = Momentary flush pushbutton less insert, flush	NEMA 1B	1NO - 1NC with common jumper (50ZAC1)	1	50AA2A	1
	A = Momentary flush pushbutton less insert, flush, chrome plate	NEMA 1B	1NO - 1NC with common jumper (50ZAC1)	1	50AA6A	1
	A = 3 position selector switch, flush, label "HAND-OFF-AUTO"	NEMA 1B	2 NO 2SPST (50ZAC8)	1	50AA2C3	1
	A = 3 position selector switch, flush, label "Off-On"	NEMA 1B	2 NO 2SPST (50ZAC8)	1	50AA2C6	1
	A = 2/3 selector switch, multiple legends, flush	NEMA 1B	2 NO 2SPST (50ZAC8)	1	50AA2B9	1
	A = 2/3 selector switch, multiple legends, chrome plate, flush	NEMA 1B	2 NO 2SPST (50ZAC8)	1	50AA6B9	1
	A = Indicator light, red, flush	NEMA 1B	120/240V dual voltage	1	50BA2Y	1
	A = Indicator light, green, flush	NEMA 1B	120/240V dual voltage	1	50BA2Z	1
	A = Indicator light, less lens, flush	NEMA 1B	120/240V dual voltage	1	50BA22	1
	A = Indicator light, less lens, chrome plate, flush	NEMA 1B	120PSB lamp	1	50BA62	1
 <p>2 unit surface mount-momentary pushbutton</p>	B = Momentary pushbutton green, surface, label "START"	NEMA 1	1NO, 1NC (50ZAC2)	2	50CA3DE	1
	A = Momentary pushbutton red, surface, label "STOP"					
	B = Momentary pushbutton green, surface, label "START"	NEMA 1	1NO, 1NC (50ZAC2)	2	50CA3DF	1
	A = Momentary raised pushbutton red, surface, label "STOP"					
	B = Momentary pushbutton green, surface, label "START"	NEMA 1	1NO, 1NC (50ZAC2)	2	50CA3DG	1
	A = Momentary mushroom head pushbutton red, surface, label "STOP"					
	B = Momentary pushbutton, less insert, surface	NEMA 1	1NO, 1NC (50ZAC2)	2	50CA3AA	1
	A = Momentary pushbutton, less insert, surface					
	B = Momentary pushbutton, surface, label "FORWARD"	NEMA 1	2 NO (50ZAC3)	2	50DA3KL	1
	A = Momentary pushbutton, surface, label "REVERSE"					



Pushbutton Units and Indicator Lights

Class 50 Standard Duty Pushbutton Stations

5A 600V AC NEMA B600

1
2
3
4
5
6
7
8
9
10

Selection and ordering data

	Operator identification	Degree of protection	Contacts / voltage	Number of command points	Order No.	Packs
						Unit
2 unit surface mount-momentary pushbutton 	B = Momentary pushbutton, surface, label "OPEN" A = Momentary pushbutton, surface, label "CLOSE"	NEMA 1	2 NO (50ZAC3)	2	50DA3HJ	1
	B = Momentary pushbutton, surface, label "UP" A = Momentary pushbutton, surface, label "DOWN"	NEMA 1	2 NO (50ZAC3)	2	50DA3NP	1
	B = Momentary pushbutton, surface, less insert A = Momentary pushbutton, surface, less insert	NEMA 1	2 NO (50ZAC3)	2	50DA3AA	1
	B = Momentary pushbutton, surface, label "FORWARD" A = Momentary pushbutton, surface, label "REVERSE"	NEMA 1	2 NO mechanically interlocked (50ZA3C w/ 50ZAM)	2	50RA3KL	1
	B = Momentary pushbutton, surface, label "OPEN" A = Momentary pushbutton, surface, label "CLOSE"	NEMA 1	2 NO mechanically interlocked (50ZA3C w/ 50ZAM)	2	50RA3HJ	1
	B = Momentary pushbutton, surface, label "UP" A = Momentary pushbutton, surface, label "DOWN"	NEMA 1	2 NO mechanically interlocked (50ZA3C w/ 50ZAM)	2	50RA3NP	1
	B = Momentary pushbutton, surface, label "ON" A = Momentary pushbutton, surface, label "OFF"	NEMA 1	2 NO mechanically interlocked (50ZA3C w/ 50ZAM)	2	50RA334	1
	B = Momentary pushbutton, less insert surface A = Momentary pushbutton, less insert, surface	NEMA 1	2 NO mechanically interlocked (50ZA3C w/ 50ZAM)	2	50RA3AA	1
	B = Momentary pushbutton, surface, label "FORWARD" A = Momentary pushbutton, surface, label "REVERSE"	NEMA 1	2 NO, 2 NC (2 - 50ZAC2)	2	50EA3KL	1
	B = Momentary pushbutton, surface, label "OPEN" A = Momentary pushbutton, surface, label "CLOSE"	NEMA 1	2 NO, 2 NC (2 - 50ZAC2)	2	50EA3HJ	1
	B = Momentary pushbutton, surface, label "UP" A = Momentary pushbutton, surface, label "DOWN"	NEMA 1	2 NO, 2 NC (2 - 50ZAC2)	2	50EA3NP	1
	B = Momentary pushbutton, surface, label "ON" A = Momentary pushbutton, surface, label "OFF"	NEMA 1	2 NO, 2 NC (2 - 50ZAC2)	2	50EA334	1
	B = Momentary pushbutton, surface, less insert A = Momentary pushbutton, surface, less insert	NEMA 1	2 NO, 2 NC (2 - 50ZAC2)	2	50EA3AA	1
	2 unit flush mount-momentary pushbutton 	B = Momentary pushbutton green, flush, label "START" A = Momentary pushbutton red, flush, label "STOP"	NEMA 1B	1NO, 1NC (50ZAC2)	2	50CA2DE
B = Momentary pushbutton, less insert, flush A = Momentary pushbutton, less insert, flush		NEMA 1B	1NO, 1NC (50ZAC2)	2	50CA2AA	1
B = Momentary pushbutton green, flush, label "START" A = Momentary raised pushbutton red, flush, label "STOP"		NEMA 1B	1NO, 1NC (50ZAC2)	2	50CA2DF	1
B = Momentary pushbutton green, flush, label "START" A = Momentary mushroom head pushbutton red, flush, label "STOP"		NEMA 1B	1NO, 1NC (50ZAC2)	2	50CA2DG	1
B = Momentary pushbutton, less insert, flush A = Momentary pushbutton, less insert, flush		NEMA 1B	1NO, 1NC (50ZAC2)	2	50CA6AA	1

Pushbutton Units and Indicator Lights

Class 50 Standard Duty Pushbutton Stations

5A 600V AC NEMA A600

Selection and ordering data

	Operator identification	Degree of protection	Contacts / voltage	Number of command points	Order No.	Packs
						Unit
2 unit flush mount-momentary pushbutton	B = Momentary pushbutton, flush, label "FORWARD" A = Momentary pushbutton, flush, label "REVERSE"	NEMA 1B	2 NO (50ZAC3)	2	50DA2KL	1
	B = Momentary pushbutton, flush, label "OPEN" A = Momentary pushbutton, flush, label "CLOSE"	NEMA 1B	2 NO (50ZAC3)	2	50DA2HJ	1
	B = Momentary pushbutton, flush, label "UP" A = Momentary pushbutton, flush, label "DOWN"	NEMA 1B	2 NO (50ZAC3)	2	50DA2NP	1
	B = Momentary pushbutton, less insert, flush A = Momentary pushbutton, less insert, flush	NEMA 1B	2 NO (50ZAC3)	2	50DA2AA	1
	B = Momentary pushbutton, less insert, chrome plate, flush A = Momentary pushbutton, less insert, chrome plate, flush	NEMA 1B	2 NO (50ZAC3)	2	50DA6AA	1
	B = Momentary pushbutton, flush, label "FORWARD" A = Momentary pushbutton, flush, label "REVERSE"	NEMA 1B	2 NO mechanically interlocked (50ZA3C w/ 50ZAM)	2	50RA2KL	1
	B = Momentary pushbutton, flush, label "OPEN" A = Momentary pushbutton, flush, label "CLOSE"	NEMA 1B	2 NO mechanically interlocked (50ZA3C w/ 50ZAM)	2	50RA2HJ	1
	B = Momentary pushbutton, flush, label "UP" A = Momentary pushbutton, flush, label "DOWN"	NEMA 1B	2 NO mechanically interlocked (50ZA3C w/ 50ZAM)	2	50RA2NP	1
	B = Momentary pushbutton, flush, label "ON" A = Momentary pushbutton, flush, label "OFF"	NEMA 1B	2 NO mechanically interlocked (50ZA3C w/ 50ZAM)	2	50RA234	1
	B = Momentary pushbutton, less insert, flush A = Momentary pushbutton, less insert, flush	NEMA 1B	2 NO mechanically interlocked (50ZA3C w/ 50ZAM)	2	50RA2AA	1
	B = Momentary pushbutton, less insert, chrome plate, flush A = Momentary pushbutton, less insert, chrome plate, flush	NEMA 1B	2 NO mechanically interlocked (50ZA3C w/ 50ZAM)	2	50RA6AA	1
	B = Momentary pushbutton, flush, label "FORWARD" A = Momentary pushbutton, flush, label "REVERSE"	NEMA 1B	2 NO, 2 NC (2 - 50ZAC2)	2	50EA2KL	1
	B = Momentary pushbutton, flush, label "OPEN" A = Momentary pushbutton, flush, label "CLOSE"	NEMA 1B	2 NO, 2 NC (2 - 50ZAC2)	2	50EA2HJ	1
	B = Momentary pushbutton, flush, label "UP" A = Momentary pushbutton, flush, label "DOWN"	NEMA 1B	2 NO, 2 NC (2 - 50ZAC2)	2	50EA2NP	1
	B = Momentary pushbutton, flush, label "ON" A = Momentary pushbutton, flush, label "OFF"	NEMA 1B	2 NO, 2 NC (2 - 50ZAC2)	2	50EA234	1
	B = Momentary pushbutton, less insert, flush A = Momentary pushbutton, less insert, flush	NEMA 1B	2 NO, 2 NC (2 - 50ZAC2)	2	50EA2AA	1
	B = Momentary pushbutton, less insert, chrome plate, flush A = Momentary pushbutton, less insert, chrome plate, flush	NEMA 1B	2 NO, 2 NC (2 - 50ZAC2)	2	50EA6AA	1

Pushbutton Units and Indicator Lights

Class 50 Standard Duty Pushbutton Stations

5A 600V AC NEMA B600

1
2
3
4
5
6
7
8
9
10

Selection and ordering data

	Operator identification	Degree of protection	Contacts / voltage	Number of command points	Order No.	Packs
						Unit
2 unit surface mount-momentary pushbutton and selector switch	B = Momentary pushbutton green, surface, label "START"	NEMA 1	1NO, 1NC (50ZAC1)	2	50FA3DC3	1
	A = Maintained selector switch, surface, label "HAND-OFF-AUTO"		2 NO 2SPDT w/ common jumper (50ZAC8)			
	B = Momentary pushbutton less insert, surface	NEMA 1	1NO, 1NC (50ZAC1)	2	50FA3AB9	1
	A = Maintained selector switch, multiple legends, surface		2 NO 2SPDT w/ common jumper (50ZAC8)			
2 unit surface mount-momentary pushbutton and indicator light	B = Indicator light, red, surface	NEMA 1	120/240V dual voltage (120PSB lamp)	2	50HA3YC3	1
	A = Maintained selector switch, surface, label "HAND-OFF-AUTO"		2 NO 2SPDT w/ common jumper (50ZAC8)			
	B = Indicator light, red, surface	NEMA 1	120/240V dual voltage (120PSB lamp)	2	50HA32B9	1
	A = Maintained selector switch, multiple legends, surface		2 NO 2SPDT w/ common jumper (50ZAC8)			
2 unit surface mount-momentary pushbutton and indicator light	B = Indicator light, green, surface	NEMA 1	120/240V dual voltage (120PSB lamp)	2	50GA3ZY	1
	A = Indicator light, red, surface		120/240V dual voltage (120PSB lamp)			
	B = Indicator light, less lens, surface	NEMA 1	120/240V dual voltage (120PSB lamp)	2	50GA322	1
	A = Indicator light, less lens, surface		120/240V dual voltage (120PSB lamp)			
2 unit flush mount-momentary pushbutton and selector switch	B = Momentary pushbutton green, flush, label "START"	NEMA 1B	1NO, 1NC (50ZAC1)	2	50FA2DC3	1
	A = Maintained selector switch, flush, label "HAND-OFF-AUTO"		2 NO 2SPDT w/ common jumper (50ZAC8)			
	B = Momentary pushbutton less insert, flush	NEMA 1B	1NO, 1NC (50ZAC1)	2	50FA2AB9	1
	A = Maintained selector switch, multiple legends, flush		2 NO 2SPDT w/ common jumper (50ZAC8)			
	B = Momentary pushbutton less insert chrome plate, flush	NEMA 1B	1NO, 1NC (50ZAC1)	2	50FA6AB9	1
	A = Maintained selector switch, multiple legends, flush		2 NO 2SPDT w/ common jumper (50ZAC8)			
	B = Indicator light, red, flush	NEMA 1B	120/240V dual voltage (120PSB lamp)	2	50HA2YC3	1
	A = Maintained selector switch, flush, label "HAND-OFF-AUTO"		2 NO 2SPDT w/ common jumper (50ZAC8)			
	B = Indicator light, less lens, flush	NEMA 1B	120/240V dual voltage (120PSB lamp)	2	50HA22B9	1
	A = Maintained selector switch, multiple legends, flush		2 NO 2SPDT w/ common jumper (50ZAC8)			
2 unit flush mount-momentary pushbutton and indicator light	B = Indicator light, green, flush	NEMA 1B	120/240V dual voltage (120PSB lamp)	2	50GA2ZY	1
	A = Indicator light, red, flush		120/240V dual voltage (120PSB lamp)			
	B = Indicator light, less lens, flush	NEMA 1B	120/240V dual voltage (120PSB lamp)	2	50GA222	1
	A = Indicator light, less lens, flush		120/240V dual voltage (120PSB lamp)			
3 unit surface mount-momentary pushbutton	B = Indicator light, less lens, chrome plate, flush	NEMA 1B	120/240V dual voltage (120PSB lamp)	2	50GA622	1
	A = Indicator light, less lens, chrome plate, flush		120/240V dual voltage (120PSB lamp)			
	C = Momentary pushbutton, surface, label "FORWARD"	NEMA 1	2 NO, 2 NC (2 - 50ZAC2)	3	50MA3KLE	1
	B = Momentary pushbutton, surface, label "REVERSE"		1NO - 1NC with common jumper (50ZAC1)			
	A = Momentary pushbutton, surface, label "STOP"					
	C = Momentary pushbutton, surface, label "UP"	NEMA 1	2 NO, 2 NC (2 - 50ZAC2)	3	50MA3NPE	1
	B = Momentary pushbutton, surface, label "DOWN"		1NO - 1NC with common jumper (50ZAC1)			
	A = Momentary pushbutton, surface, label "STOP"					
	C = Momentary pushbutton, surface, label "OPEN"	NEMA 1	2 NO, 2 NC (2 - 50ZAC2)	3	50MA3HJE	1
	B = Momentary pushbutton, surface, label "CLOSE"		1NO - 1NC with common jumper (50ZAC1)			
A = Momentary pushbutton, surface, label "STOP"						

Pushbutton Units and Indicator Lights

Class 50 Standard Duty Pushbutton Stations

5A 600V AC NEMA B600

Selection and ordering data



	Operator identification	Degree of protection	Contacts / voltage	Number of command points	Order No.	Packs
						Unit
3 unit surface mount-momentary pushbutton	C = Momentary pushbutton, surface, label "FAST"	NEMA 1	2 NO, 2 NC (2 - 50ZAC2) 1NO - 1NC with common jumper (50ZAC1)	3	50MA3TUE	1
	B = Momentary pushbutton, surface, label "SLOW"					
	A = Momentary pushbutton, surface, label "STOP"					
	C = Momentary pushbutton, surface, label "START"	NEMA 1	2 NO, 2 NC (2 - 50ZAC2) 1NO - 1NC with common jumper (50ZAC1)	3	50MA3DME	1
	B = Momentary pushbutton, surface, label "JOG"					
	A = Momentary pushbutton, surface, label "STOP"					
	C = Momentary pushbutton, surface, label less insert	NEMA 1	2 NO, 2 NC (2 - 50ZAC2) 1NO - 1NC with common jumper (50ZAC1)	3	50MA3AAA	1
	B = Momentary pushbutton, surface, label less insert					
	A = Momentary pushbutton, surface, label less insert					
3 unit surface mount-momentary pushbutton and selector switch	C = Momentary pushbutton, surface, label "START"	NEMA 1	1 NO, 1 NC (50ZAC2) 2 NO, 2 SPST with common jumper (50ZAC8)	3	50LA3DEC3	1
	B = Momentary pushbutton, surface, label "STOP"					
	A = Maintained selector switch, surface, label "HAND-OFF-AUTO"					
	C = Momentary pushbutton, less insert, surface	NEMA 1	1 NO, 1 NC (50ZAC2) 2 NO, 2 SPST with common jumper (50ZAC8)	3	50LA3AAB9	1
	B = Momentary pushbutton, less insert, surface					
	A = Maintained selector switch, multiple legends, surface					
3 unit surface mount-momentary pushbutton and indicator light	C = Indicator light, red, surface	NEMA 1	120/240V dual voltage (120PSB lamp) 1 NO, 1 NC (50ZAC2)	3	50JA3YDE	1
	B = Momentary pushbutton, surface, label "START"					
	A = Momentary pushbutton, surface, label "STOP"					
	C = Indicator light, green, surface	NEMA 1	120/240V dual voltage (120PSB lamp) 1 NO, 1 NC (50ZAC2)	3	50JA3ZDE	1
	B = Momentary pushbutton, surface, label "START"					
	A = Momentary pushbutton, surface, label "STOP"					
	C = Indicator light, less lens, surface	NEMA 1	120/240V dual voltage (120PSB lamp) 1 NO, 1 NC (50ZAC2)	3	50JA32AA	1
	B = Momentary pushbutton, less insert, surface					
	A = Momentary pushbutton, less insert, surface					
	C = Indicator light, green, surface	NEMA 1	120/240V dual voltage (120PSB lamp) 2 NO, 2 SPST with common jumper (50ZAC8)	3	50NA3ZYC3	1
	B = Indicator light, red, surface					
	A = Maintained selector switch, surface, label "HAND-OFF-AUTO"					
	C = Indicator light, less lens, surface	NEMA 1	120/240V dual voltage (120PSB lamp) 2 NO, 2 SPST with common jumper (50ZAC8)	3	50NA322B9	1
	B = Indicator light, less lens, surface					
	A = Maintained selector switch, multiple legends, surface					

Pushbutton Units and Indicator Lights

Class 50 Standard Duty Pushbutton Stations

Heavy duty - 10A 600V AC NEMA A600

Selection and ordering data

	Operator identification	Degree of protection	Contacts / voltage	Number of command points	Order No.	Packs	
						Unit	
	A = Momentary pushbutton green, surface, label "START"	NEMA 4	1NO - 1NC	1	50HA1E1	1	
	A = Momentary pushbutton red, surface, label "STOP"	NEMA 4	1NO - 1NC	1	50HA1E2	1	
	A = Momentary pushbutton green, surface, label "RESET"	NEMA 4	1NO - 1NC	1	50HA1E4	1	
	A = Momentary pushbutton green, surface, label "JOG"	NEMA 4	1NO - 1NC	1	50HA1E5	1	
	A = Maintained selector switch, surface, label "SAFE-RUN"	NEMA 4	1NO - 1NC	1	50HA1E6	1	
	A = Maintained selector switch, surface, label "OFF-ON"	NEMA 4	1NO - 1NC	1	50HA1E7	1	
	A = Maintained selector switch, surface, label "JOG-RUN"	NEMA 4	1NO - 1NC	1	50HA1E8	1	
	A = Maintained selector switch, surface, label "HAND-OFF-AUTO"	NEMA 4	1NO - 1NC	1	50HA1E9	1	
		B = Momentary pushbutton green, surface, label "START"	NEMA 4	1NO - 1NC	2	50HA2E1	1
A = Momentary pushbutton red, surface, label "STOP"			1NO - 1NC				
B = Momentary pushbutton green, surface, label "FORWARD"		NEMA 4	1NO - 1NC	2	50HA2E2	1	
A = Momentary pushbutton red, surface, label "REVERSE"			1NO - 1NC				
B = Momentary pushbutton green, surface, label "UP"		NEMA 4	1NO - 1NC	2	50HA2E3	1	
A = Momentary pushbutton red, surface, label "DOWN"			1NO - 1NC				
B = Momentary pushbutton green, surface, label "OPEN"		NEMA 4	1NO - 1NC	2	50HA2E4	1	
A = Momentary pushbutton red, surface, label "CLOSE"			1NO - 1NC				
B = Momentary pushbutton green, surface, label "FAST"		NEMA 4	1NO - 1NC	2	50HA2E5	1	
A = Momentary pushbutton red, surface, label "SLOW"			1NO - 1NC				
		C = Momentary pushbutton green, surface, label "FORWARD"	NEMA 4	1NO - 1NC	3	50HA3E1	1
		B = Momentary pushbutton green, surface, label "REVERSE"		1NO - 1NC			
	A = Momentary pushbutton red, surface, label "STOP"		1NO - 1NC				
	C = Momentary pushbutton green, surface, label "UP"	NEMA 4	1NO - 1NC	3	50HA3E2	1	
	B = Momentary pushbutton green, surface, label "DOWN"		1NO - 1NC				
	A = Momentary pushbutton red, surface, label "STOP"		1NO - 1NC				
	C = Momentary pushbutton green, surface, label "OPEN"	NEMA 4	1NO - 1NC	3	50HA3E3	1	
	B = Momentary pushbutton green, surface, label "CLOSE"		1NO - 1NC				
	A = Momentary pushbutton red, surface, label "STOP"		1NO - 1NC				
	C = Momentary pushbutton green, surface, label "START"	NEMA 4	1NO - 1NC	3	50HA3E9	1	
	B = Momentary pushbutton green, surface, label "JOG"		1NO - 1NC				
	A = Momentary pushbutton red, surface, label "STOP"		1NO - 1NC				
	C = Momentary pushbutton green, surface, label "FAST"	NEMA 4	1NO - 1NC	3	50HA3E4	1	
	B = Momentary pushbutton green, surface, label "SLOW"		1NO - 1NC				
	A = Momentary pushbutton red, surface, label "STOP"		1NO - 1NC				

Pushbutton Units and Indicator Lights





Class 50 Standard Duty Pushbutton Stations

Standard duty station accessories

Selection and ordering data

Legend inscription insert for snap-on mounting

Inscription	Color	Order No.	Pack
			Unit
Close	Orange	50D53493005	1
Down	Orange	50D53493010	1
Fast	Black	50D53493013	1
Forward	Green	50D53493006	1
High	Black	50D53493015	1
Hoist	Green	50D53493011	1
Jog	Black	50D53493008	1
Low	Black	50D53493016	1
Lower	Orange	50D53493012	1
Off	Red	50D53493018	1
On	Green	50D53493017	1
Open	Green	50D53493004	1
Reverse	Orange	50D53493007	1
Slow	Black	50D53493014	1
Start	Green	50D53493001	1
Stop	Red	50D53493002	1
Stop (raised)	Red	50D53493003	1
Up	Green	50D53493009	1

Version	Suitable for	Color	Order No.	Pack
				Unit
 50ZAC1		Red	50ZMH	1
 50ZAC2	Used only for raised buttons		50ZAL	1
			50ZAM	1
Mechanical interlock kit				
Contact blocks				
	Single button		50ZAC1	1
	Selector switch		50ZAC8	1
	Two button		50ZAC2	1
	Two button		50ZAC3	1
 50ZAC8				
 50ZAC3				
Pilot light	120/240V Dual Voltage, no lens		50ZAC6	1
Pilot light lens		Red	50ZPL01	1
		Green	50ZPL02	1
Replacement lamps	Class 50 type 1, 1B 120V		50D21983001	1
Slide base, lamp type 120PSB				

Heavy duty station accessories

Version	Suitable for	Color	Order No.	Pack
				Unit
Pushbutton caps	NEMA 4 control stations	Red	BHP15X	1
	NEMA 4 control stations	Black	BHP16X	1

Pushbutton Units and Indicator Lights

Class 50 Standard Duty Pushbutton Stations

Standard duty - 5A 600V AC NEMA B600

- 1
- 2
- 3
- 4
- 5
- 6
- 7
- 8
- 9
- 10

1 Unit Station Surface Mounting—Type 1

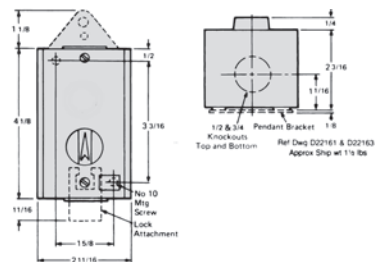

1 Unit Station Flush Mounting—Type 1B

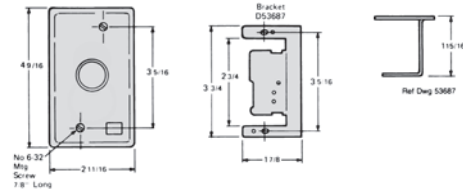

2 Pushbutton Stations Surface Mounting—Type 1

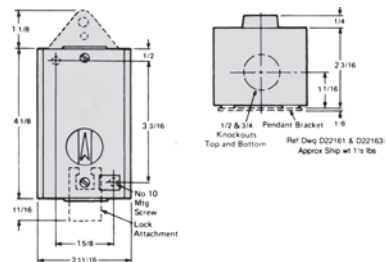

2 Pushbutton Stations Flush Mounting—Type 1B

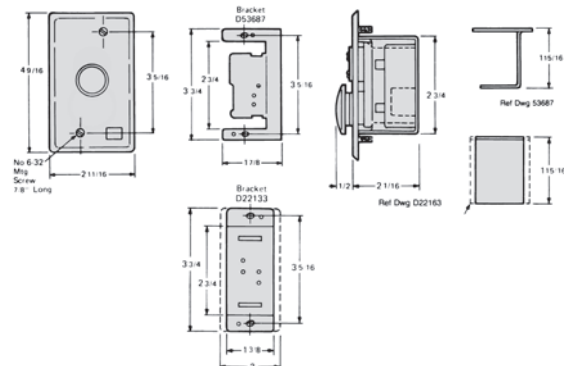

2 Unit Stations Surface Mounting—Type 1

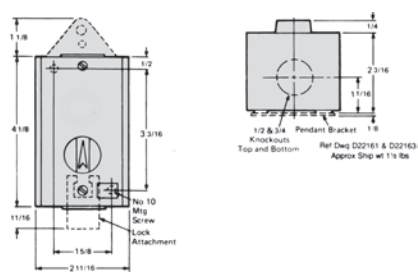

2 Unit Station Flush Mounting—Type 1B

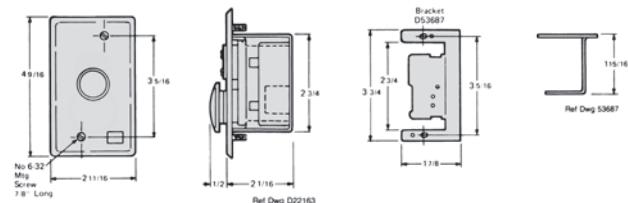

3 Unit Stations Surface Mounting

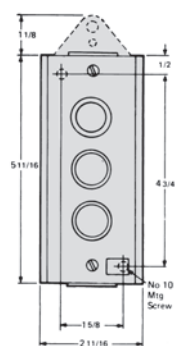

1 Unit Stations—Type 4

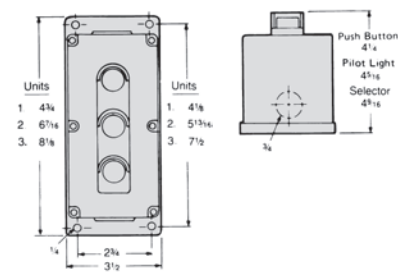

Pushbutton Units and Indicator Lights

Class 51 Pilot Devices

Hazardous location

Features

- UL Listed and cUL Listed for Class I, Groups C & D and Class II, Groups E, F & G
- Short or Long Bushing Lengths
- Mount into 3/4-14 NPSM Threaded Hole
- Sealing Lock Nut
- Similar in Appearance to Class 52 Oil Tight Pilot Devices
- Double Break Bifurcated Contacts Rated AC NEMA A600, DC NEMA P600
- ⊕ Positively Driven Contacts
- Touchsafe Terminals
- UL Listed File # E39935

Application

When properly installed in a Type 7 & 9 enclosure, these components meet the National Electrical Code's requirements for Class I, Division 1 & 2, Groups C and D hazardous gases, Class II, Division 1, Groups E, F and G hazardous dust, and Class III, hazardous fibers and flyings. Class 51 pilot devices may be used in a location where the presence of flammable gases, vapors or finely pulverized dusts in the atmosphere are sufficient to create a threat of explosion or fire. They may also be required where easily ignitable fibers or flyings are present. Short bushing units are used in most standard Type 7 & 9 enclosures. Long bushings are used when an additional front panel is required or in enclosures up to 2 V8 inches thick. Class 51 devices also meet Type 4 applications.

Rugged

Hazardous location control units are durable one piece castings of a corrosion resistant copper free aluminum alloy with stainless steel springs and type 316 stainless steel shafts to provide a long dependable life. The "O" ring ensures the longest seal life available. Contact blocks have double break bifurcated contacts for increased reliability.

Flexible

Control units mount into industry standard 3/4-14 NPSM threaded holes. Both short bushings for enclosure mounting and long bushings for panel mounting are available.

Pilot light bulbs are removable from the front for ease of maintenance. Many common parts between the Class 51 hazardous location pilot devices and the Class 52 oil tight pilot devices allow for increased serviceability with fewer parts.

Industrial Appearance

Hazardous location control units add luster to panels. They are uniform in appearance and match 52 Class oil tight pilot devices.

Typical Applications

Class I

Class II

Class III

Electrical Ratings

NEMA AC Ratings 50/60Hz

Nema A600 10 Continuous Amps

Volts	Make	Break
120	60	6
240	30	3
480	15	1.5
600	12	1.2
VA	7200	720

Ordering Information

- Accessories [see page 10/140-10/141.](#)
- Selector Operating Position and Contact Operation [page 10/138.](#)
- Legend Plates [see page 10/177.](#)
- Enclosures [see page 10/139.](#)
- Technical Specifications: [page 10/179.](#)

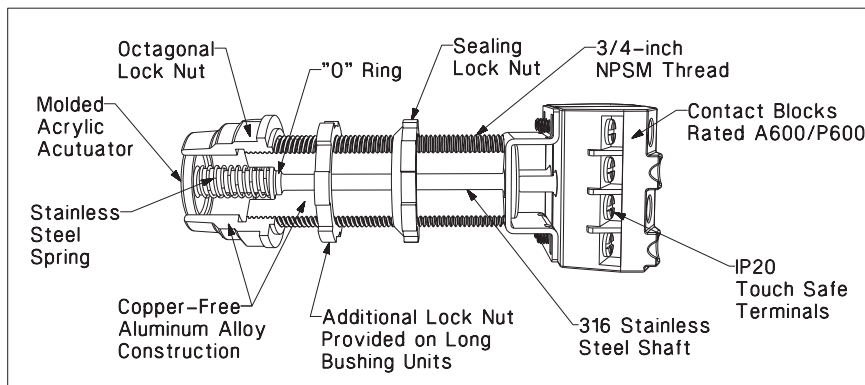

Panel Spacing

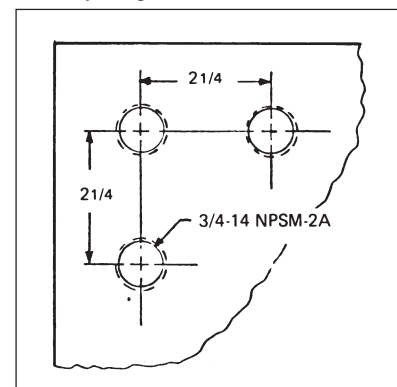





Pushbutton Units and Indicator Lights

Class 51, Hazardous Location NEMA Type 7 & 9 Devices

Operators only

1
2
3
4
5
6
7
8
9
10

Selection and ordering data

	Version	Color of operator	Contacts	Short bushing Order No.	Long bushing Order No.	Pack Unit
Pushbutton with flat cap 	Pushbutton with flush cap	Black		51PA8A1	51PA8A1LB	1
		Red		51PA8A2	51PA8A2LB	1
		Green		51PA8A3	51PA8A3LB	1
Pushbutton with extended cap 	Pushbutton with extended cap	Black		51PA8B1	51PA8B1LB	1
		Red		51PA8B2	51PA8B2LB	1
		Green		51PA8B3	51PA8B3LB	1
Dual pushbutton 	Dual Pushbutton	Flush Black		51PD8A1B2	51PD8A1B2LB	1
		Raised Red				
	Pushbutton with mushroom cap 1 5/8"(41.3mm)	Black		51PA9D1	51PA9D1LB	1
		Red		51PA9D2	51PA9D2LB	1
		Green		51PA9D3	51PA9D3LB	1
	Pushbutton with mushroom cap 2 1/2"(63.5mm)	Black		51PA9E1	51PA9E1LB	1
		Red		51PA9E2	51PA9E2LB	1
		Green		51PA9E3	51PA9E3LB	1
		Less head		51PA9	51PA9LB	1
2 position push-pull 	2 Position Push Pull Maintained, Non Illuminated Small Plastic Mushroom Head, 1 5/8" (41.3 mm)	Black		51PA2D1	51PA2D1LB	1
		Red		51PA2D2	51PA2D2LB	1
		Green		51PA2D3	51PA2D3LB	1
	Large Plastic Mushroom Head, 2 1/4" (57.2 mm)	Black		51PA2E1	51PA2E1LB	1
		Red		51PA2E2	51PA2E2LB	1
		Green		51PA2E3	51PA2E3LB	1
		Less head		51PA2	51PA2LB	1
	2 Position Push Pull Maintained, Non Illuminated Small Mushroom Head, 1 5/8"(41.3mm)	Black	1NC + 1NO	51PA2D1A	51PA2D1LBA	1
		Red	1NC + 1NO	51PA2D2A	51PA2D2LBA	1
		Green	1NC + 1NO	51PA2D3A	51PA2D3LBA	1
Large Mushroom Head, 2 1/2"(63.5mm)	Black	1NC + 1NO	51PA2E1A	51PA2E1LBA	1	
	Red	1NC + 1NO	51PA2E2A	51PA2E2LBA	1	
	Green	1NC + 1NO	51PA2E3A	51PA2E3LBA	1	
3 position push-pull 	3 Position Push Pull Momentary, Non Illuminated Small Mushroom Head, 1 5/8"(41.3mm)	Black	1NC + 1NO	51PA3A1U	51PA3A1ULB	1
		Red	1NC + 1NO	51PA3A2U	51PA3A2ULB	1
		Green	1NC + 1NO	51PA3A3U	51PA3A3ULB	1

Pushbutton Units and Indicator Lights

Class 51, Hazardous Location NEMA Type 7 & 9 Devices

Indicator light

Selection and ordering data

Version	Color of operator	Contacts	Short bushing Order No.	Long bushing Order No.	Pack Unit	
Indicator light with glass lens - Full voltage type AC/DC (with 6" pigtail leads)^{1) 3)} Operators with Incandescent Lamp 6-8V with 755 type 12V with 756 type 24V with 757 type Operators with LED Lamp ²⁾ 6-8V with BA9 type LED 24V with BA9 type LED	Red		51PC5B2	51PC5B2LB	1	
	Green		51PC5B3	51PC5B3LB		
	Amber		51PC5B9	51PC5B9LB		
	Less lens		51PC5BN	51PC5BNLB		
		Red		51PC5C2	51PC5C2LB	1
		Green		51PC5C3	51PC5C3LB	
		Amber		51PC5C9	51PC5C9LB	
		Less lens		51PC5CN	51PC5CNLB	
		Red		51PC5D2	51PC5D2LB	1
		Green		51PC5D3	51PC5D3LB	
		Amber		51PC5D9	51PC5D9LB	
		Less lens		51PC5DN	51PC5DNLB	
	Red		51PE5B2	51PE5B2LB	1	
	Green		51PE5B3	51PE5B3LB		
	Amber		51PE5B9	51PE5B9LB		
	Red		51PE5D2	51PE5D2LB	1	
	Green		51PE5D3	51PE5D3LB		
	Amber		51PE5D9	51PE5D9LB		
Indicator light with glass lens - Transformer type AC/DC^{1) 3)} Operators with Incandescent Lamp 120V with 6V 755 type lamp 240V with 6V 755 type lamp 480V with 6V 755 type lamp 600V with 6V 755 type lamp Operators with LED Lamp ²⁾ 120V with 6V BA9 type LED 240V with 6V BA9 type LED 480V with 6V BA9 type LED 600V with 6V BA9 type LED	Red		51PC5G2	51PC5G2LB	1	
	Green		51PC5G3	51PC5G3LB		
	Amber		51PC5G9	51PC5G9LB		
	Less lens		51PC5GN	51PC5GNLB		
		Red		51PC5H2	51PC5H2LB	1
		Green		51PC5H3	51PC5H3LB	
		Amber		51PC5H9	51PC5H9LB	
		Less lens		51PC5HN	51PC5HNLB	
		Red		51PC5J2	51PC5J2LB	1
		Green		51PC5J3	51PC5J3LB	
		Amber		51PC5J9	51PC5J9LB	
		Less lens		51PC5JN	51PC5JNLB	
		Red		51PC5K2	51PC5K2LB	1
		Green		51PC5K3	51PC5K3LB	
		Amber		51PC5K9	51PC5K9LB	
		Less lens		51PC5KN	51PC5KNLB	
		Red		51PE5G2	51PE5G2LB	1
		Green		51PE5G3	51PE5G3LB	
		Amber		51PE5G9	51PE5G9LB	
		Less lens		—	—	
		Red		51PE5H2	51PE5H2LB	1
		Green		51PE5H3	51PE5H3LB	
		Amber		51PE5H9	51PE5H9LB	
		Less lens		—	—	
	Red		51PE5J2	51PE5J3LB	1	
	Green		51PE5J3	51PE5J3LB		
	Amber		51PE5J9	51PE5J9LB		
	Less lens		—	—		
	Red		51PE5K2	51PE5K2LB	1	
	Green		51PE5K3	51PE5K3LB		
	Amber		51PE5K9	51PE5K9LB		
	Less lens		—	—		
Indicator light with glass lens - Resistor type AC/DC* 120V with 24V 757 type lamp 120V with 24V BA9 type LED lamp ²⁾	Red		51PC5M2	51PC5M2LB	1	
	Green		51PC5M3	51PC5M3LB		
	Amber		51PC5M9	51PC5M9LB		
	Less lens		51PC5MN	51PC5MNLB		
		Red		51PE5M2	51PE5M2LB	1
		Green		51PE5M3	51PE5M3LB	
	Amber		51PE5M9	51PE5M9LB		

1) For other colors not listed, order operator less lens and separate lens from page 10/127.

2) LED color must match lens color.

3) All illuminated devices come with std. Touch-safe shield per UL stds.



Pushbutton Units and Indicator Lights

Class 51, Hazardous Location NEMA Type 7 & 9 Devices



Push to test complete units

1
2
3
4
5
6
7
8
9
10

Selection and ordering data

Version	Color of operator	Contacts	Short bushing Order No.	Long bushing Order No.	Pack Unit	
 <p>Push to test full voltage</p>	Push to test/Illuminated pushbutton with glass lens - Full voltage type AC/DC^{1) 3)}					
	Operators with Incandescent Lamp	Red	1NO + 1NC	51PC6B2A	51PC6B2ALB	1
	6V with 755 type lamp	Green	1NO + 1NC	51PC6B3A	51PC6B3ALB	1
		Amber	1NO + 1NC	51PC6B9A	51PC6B9ALB	1
		Less lens	1NO + 1NC	51PC6BNA	51PC6BNALB	1
	24V with 757 type lamp	Red	1NO + 1NC	51PC6D2A	51PC6D2ALB	1
		Amber	1NO + 1NC	51PC6D3A	51PC6D3ALB	1
		Green	1NO + 1NC	51PC6D9A	51PC6D9ALB	1
		Less lens	1NO + 1NC	51PC6DNA	51PC6DNALB	1
	Operators with LED Lamp ²⁾	Red	1NO + 1NC	51PE6B2A	51PE6B2ALB	1
6-8V with BA9 type LED	Green	1NO + 1NC	51PE6B3A	51PE6B3ALB	1	
	Amber	1NO + 1NC	51PE6B9A	51PE6B9ALB	1	
24V with BA9 type LED	Red	1NO + 1NC	51PE6D2A	51PE6D2ALB	1	
	Green	1NO + 1NC	51PE6D3A	51PE6D3ALB	1	
	Amber	1NO + 1NC	51PE6D9A	51PE6D9ALB	1	
 <p>Push to test transformer type</p>	Push to test/Illuminated pushbutton with glass lens - Transformer type (50/60 Hz)^{1) 3)}					
	Operators with Incandescent Lamp	Red	1NO + 1NC	51PC6G2A	51PC6G2ALB	1
	120V with 6V 755 type lamp	Green	1NO + 1NC	51PC6G3A	51PC6G3ALB	1
		Amber	1NO + 1NC	51PC6G9A	51PC6G9ALB	1
		Less lens	1NO + 1NC	51PC6GNA	51PC6GNALB	1
	240V with 6V 755 type lamp	Red	1NO + 1NC	51PC6H2A	51PC6H2ALB	1
		Green	1NO + 1NC	51PC6H3A	51PC6H3ALB	1
		Amber	1NO + 1NC	51PC6H9A	51PC6H9ALB	1
		Less lens	1NO + 1NC	51PC6HNA	51PC6HNALB	1
	480V with 6V 755 type lamp	Red	1NO + 1NC	51PC6J2A	51PC6J2ALB	1
	Green	1NO + 1NC	51PC6J3A	51PC6J3ALB	1	
	Amber	1NO + 1NC	51PC6J9A	51PC6J9ALB	1	
	Less lens	1NO + 1NC	51PC6JNA	51PC6JNALB	1	
600V with 6V 755 type lamp	Red	1NO + 1NC	51PC6K2A	51PC6K2ALB	1	
	Green	1NO + 1NC	51PC6K3A	51PC6K3ALB	1	
	Amber	1NO + 1NC	51PC6K9A	51PC6K9ALB	1	
	Less lens	1NO + 1NC	51PC6KNA	51PC6KNALB	1	
Operators with LED Lamp ²⁾	Red	1NO + 1NC	51PE6G2A	51PE6G2ALB	1	
120V with 6V BA9 type LED	Green	1NO + 1NC	51PE6G3A	51PE6G3ALB	1	
	Amber	1NO + 1NC	51PE6G9A	51PE6G9ALB	1	
240V with 6V BA9 type LED	Red	1NO + 1NC	51PE6H2A	51PE6H2ALB	1	
	Green	1NO + 1NC	51PE6H3A	51PE6H3ALB	1	
	Amber	1NO + 1NC	51PE6H9A	51PE6H9ALB	1	
480V with 6V BA9 type LED	Red	1NO + 1NC	51PE6J2A	51PE6J2ALB	1	
	Green	1NO + 1NC	51PE6J3A	51PE6J3ALB	1	
	Amber	1NO + 1NC	51PE6J9A	51PE6J9ALB	1	
600V with 6V BA9 type LED	Red	1NO + 1NC	51PE6K2A	51PE6K2ALB	1	
	Green	1NO + 1NC	51PE6K3A	51PE6K3ALB	1	
	Amber	1NO + 1NC	51PE6K9A	51PE6K9ALB	1	

Overload reset operators with reset legend plate

Version	Color	Legend Inscription	Order No.
 <p>Single unit 7/8" diameter reset pad, 10" shaft can be cut to length.</p>	Red	Reset	51AAS
 <p>Multi unit For use with multi push operation requirements.</p>	Red	Reset	51AAM

1) For other colors not listed, order operator less lens and separate lens from page 10/127.

2) LED color must match lens color.



3) All illuminated devices come with std. Touch-safe shield per UL stds.

Pushbutton Units and Indicator Lights

Class 51, Hazardous Location NEMA Type 7 & 9 Devices

Selector switch operators

Selection and ordering data

Version	Lever type	Color of insert	Cam Code ^{1) 2)}	Short bushing Order No.	Long bushing Order No.	Pack Unit
	Short lever, non-Illuminated	White	A	51SA2AA	51SA2AALB	1
	Long lever, non-Illuminated	White	A	51SB2AA	51SB2AALB	
Spring return from right operation	Short lever, non-Illuminated	White	A	51SA2AC	51SA2ACLB	1
	Long lever, non-Illuminated	White	A	51SB2AC	51SB2ACLB	
	Short lever, non-Illuminated	White	B	51SA2BA	51SA2BALB	1
	Long lever, non-Illuminated	White	B	51SB2BA	51SB2BALB	
	Short lever, non-Illuminated	White	C	51SA2CA	51SA2CALB	
	Long lever, non-Illuminated	White	C	51SB2CA	51SB2CALB	
	Short lever, non-Illuminated	White	D	51SA2DA	51SA2DALB	
	Long lever, non-Illuminated	White	D	51SB2DA	51SB2DALB	
	Short lever, non-Illuminated	White	E	51SA2EA	51SA2EALB	
	Long lever, non-Illuminated	White	E	51SB2EA	51SB2EALB	
	Short lever, non-Illuminated	White	G	51SA2GA	51SA2GALB	
	Long lever, non-Illuminated	White	G	51SB2GA	51SB2GALB	
Spring return from right operation	Short lever, non-Illuminated	White	B	51SA2BC	51SA2BCLB	1
	Long lever, non-Illuminated	White	B	51SB2BC	51SB2BCLB	
	Short lever, non-Illuminated	White	C	51SA2CC	51SA2CCLB	
	Long lever, non-Illuminated	White	C	51SB2CC	51SB2CCLB	
	Short lever, non-Illuminated	White	D	51SA2DC	51SA2DCLB	
	Long lever, non-Illuminated	White	D	51SB2DC	51SB2DCLB	
	Short lever, non-Illuminated	White	E	51SA2EC	51SA2ECLB	
	Long lever, non-Illuminated	White	E	51SB2EC	51SB2ECLB	
Spring return from left operation	Short lever, non-Illuminated	White	B	51SA2BB	51SA2BBLB	1
	Long lever, non-Illuminated	White	B	51SB2BB	51SB2BBLB	
	Short lever, non-Illuminated	White	C	51SA2CB	51SA2CBLB	
	Long lever, non-Illuminated	White	C	51SB2CB	51SB2CBLB	
	Short lever, non-Illuminated	White	D	51SA2DB	51SA2DBLB	
	Long lever, non-Illuminated	White	D	51SB2DB	51SB2DBLB	
	Short lever, non-Illuminated	White	E	51SA2EB	51SA2EBLB	
	Long lever, non-Illuminated	White	E	51SB2EB	51SB2EBLB	
Spring return from left and right operation	Short lever, non-Illuminated	White	B	51SA2BD	51SA2BDLB	1
	Long lever, non-Illuminated	White	B	51SB2BD	51SB2BDLB	
	Short lever, non-Illuminated	White	C	51SA2CD	51SA2CDLB	
	Long lever, non-Illuminated	White	C	51SB2CD	51SB2CDLB	
	Short lever, non-Illuminated	White	D	51SA2DD	51SA2DDLb	
	Long lever, non-Illuminated	White	D	51SB2DD	51SB2DDLb	
	Short lever, non-Illuminated	White	E	51SA2ED	51SA2EDLB	
	Long lever, non-Illuminated	White	E	51SB2ED	51SB2EDLB	
	Short lever, non-Illuminated	White	G	51SA2GD	51SA2GDLB	
	Long lever, non-Illuminated	White	G	51SB2GD	51SB2GDLB	

1) C CAM limited to 4 single or double pole blocks on spring return operators.

2) For contact operation, see CAM selection chart on [page 10/138](#).

Pushbutton Units and Indicator Lights

Class 51, Hazardous Location NEMA Type 7 & 9 Devices

Selector switch operators

1
2
3
4
5
6
7
8
9
10

Selection and ordering data



Version	Key removal position	Lock number	CAM Code ^{1) 2)}	Short bushing Order No.	Long bushing Order No.	Pack Unit
Key-operated selector switches with 2 switching positions	Both	550CH	A	51SA6AE	51SA6AELB	1
	Left	550CH	A	51SA6AF	51SA6AFLB	
Maintained operation						
Spring return from right operation	Left	550CH	A	51SA6AC	51SA6ACLB	1
Key-operated selector switches with 3 switching positions	All	550CH	B	51SA6BE	51SA6BELB	1
			C	51SA6CE	51SA6CELB	
Maintained operation						
Left	550CH	B	51SA6BF	51SA6BFLB	1	
		C	51SA6CF	51SA6CFLB		
		D	51SA6DF	51SA6DFLB		
		E	51SA6EF	51SA6EFLB		
Right	550CH	B	51SA6BG	51SA6BGLB	1	
		C	51SA6CG	51SA6CGLB		
		D	51SA6DG	51SA6DGLB		
		E	51SA6EG	51SA6EGLB		
Center	550CH	B	51SA6BH	51SA6BHLB	1	
		C	51SA6CH	51SA6CHLB		
		D	51SA6DH	51SA6DHLB		
		E	51SA6EH	51SA6EHLB		
Left and Center	550CH	B	51SA6BK	51SA6BKLB	1	
		C	51SA6CK	51SA6CKLB		
		D	51SA6DK	51SA6DKLB		
		E	51SA6EK	51SA6EKLB		
Spring return from right operation	Center	550CH	B	51SA6BU	51SA6BULB	1
			C	51SA6CU	51SA6CULB	
			D	51SA6DU	51SA6DULB	
			E	51SA6EU	51SA6EULB	
Spring return from left operation	Center	550CH	B	51SA6BT	51SA6BTLB	1
			C	51SA6CT	51SA6CTLB	
			D	51SA6DT	51SA6DTLB	
			E	51SA6ET	51SA6ETLB	
Spring return from left and right operation	Center	550CH	B	51SA6BV	51SA6BVLB	1
			C	51SA6CV	51SA6CVLB	
			D	51SA6DV	51SA6DVLB	
			E	51SA6EV	51SA6EVLB	
			G	51SA6GV	51SA6GVLB	

To order 1 to 25 special locks for keyed selector switches simply replace the 6 in the 5th digit of the catalog number with a 5 when entering your order. (Ordering Example: 52SC6AE is changed to 52SC5AE and all locks - up to

5

5

To order special locks for keyed selector switches, append corresponding 'X' suffix to part number

Ordering example:
51SA6AEX298

#549CH	X639	1
#548CH	X640	1
#547CH	X641	1
#501CH	X642	1
#506CH	X643	1

1) CAM limited to 4 single or double pole blocks on spring return operators.

2) For contact operation, see CAM selection chart on [page 10/138](#).

Pushbutton Units and Indicator Lights

Class 51, Hazardous Location NEMA Type 7 & 9 Devices

Cam selection

Selection and ordering data

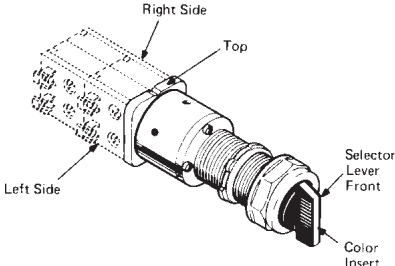
Design	Ordering Information
	<ul style="list-style-type: none"> Contact blocks are ordered separately, see page 10/141. Determine which table to use based upon the type of selector (non-illuminated & keyed on top, illuminated on bottom). Find the correct number of selector positions (2, 3 or 4 positions). Select the contact operation required for each selector position. X indicates the contacts are closed, while O indicates the contacts are open. (For the selector pushbutton, N=normal and D=depressed). Contact block must be assembled in position shown for each circuit application. Identify the CAM letter required for the chosen contact operation (only 1 CAM can be used per selector switch or selector pushbutton). Contact blocks must be assembled in the position shown for each circuit application. The mounting position is viewed from the front of the device. <p>Ordering CAMs D, E or G</p> <ul style="list-style-type: none"> CAM D, E or G may be ordered at the same price by changing the 6th character of the selector catalog number. Example: Selector with D cam 51SA2DA. <p>Size Requirements</p> <ul style="list-style-type: none"> C CAM on spring return selectors is limited to 4 contact blocks. Standard push buttons accept 4 contact blocks on each side, for a maximum of 8 contact blocks. Selector operators in enclosures are limited to depth of 1 contact block. (2 blocks wide).

Non-illuminated and keyed selector switches (viewed from front)

2 Selector Positions			Contact Blocks	CAM	Mounting	
Left	Right				Left	Right
X	O		52BAJ (NC)	A	L	R
O	X		52BAK (NO)	A	L	R
3 Selector Positions			Contact Blocks	CAM	Mounting	
Left	Center	Right			Left	Right
X	O	O	52BAK (NO)	B		R
O	O	X	52BAK (NO)	B	L	
X	X	O	52BAJ (NC)	B	L	
O	X	X	52BAJ (NC)	B	R	
O	O	X	52BAK (NO)	C	L	R
X	O	O	52BAJ (NC)	C	L	R
O	O	X	52BAK (NO)	D	L	R
O	X	O	52BAJ (NC)	D	L	R
X	O	O	52BAK (NO)	E	L	R
O	X	O	52BAJ (NC)	E	L	R
X	O	O	52BAJ (NC)	G	L	
O	X	O	52BAJ (NC)	G		R
O	O	X	52BAK (NO)	G	L	R

Illuminated selector switches

2 Selector Positions			Contact Blocks	CAM	Mounting	
Left	Right				Left	Right
X	O		52BAJ (NC)	A	L	
O	X		52BAK (NO)	A	L	

1) Wired in parallel.





Pushbutton Units and Indicator Lights

Class 51, Hazardous Location NEMA Type 7 & 9 Devices

Control stations

1
2
3
4
5
6
7
8
9
10

Selection and ordering data

	Operator Identification ¹⁾	Degree of operator	Contacts/voltage	Number of command points	Order No.	Pack	
							Unit
	A = Momentary flush pushbutton black, label "START"	NEMA 7/9	1NO - 1NC	1	51C101H	1	
	A = Momentary raised pushbutton red, label "STOP"	NEMA 7/9	1NO - 1NC	1	51C103H	1	
	A = Momentary 1 5/8" mushroom head red label "STOP"	NEMA 7/9	1NO - 1NC	1	51C104H	1	
	A = Momentary dual pushbutton red label "START, STOP"	NEMA 7/9	1NO - 1NC	1	51C105H	1	
	A = 2 position selector switch label "Off-On"	NEMA 7/9	1NO - 1NC	1	51C159H	1	
	A = 3 position selector switch label "HAND-OFF-AUTO"	NEMA 7/9	1NO - 1NC	1	51C156H	1	
	A = Indicator light, green, 120 V	NEMA 7/9			1	51C131H	1
	A = Indicator light, red, 120 V	NEMA 7/9			1	51C135H	1
	B = Momentary flush pushbutton black, label "START" A = Momentary raised pushbutton red, label "STOP"	NEMA 7/9	1NO - 1NC 1NO - 1NC	2	51C201H	1	
	B = Momentary flush pushbutton black, label "FORWARD" A = Momentary flush pushbutton red, label "REV"	NEMA 7/9	1NO - 1NC 1NO - 1NC	2	51C204H	1	
	B = Momentary flush pushbutton black, label "START" A = Momentary 1 5/8" mushroom head pushbutton red, label "STOP"	NEMA 7/9	1NO - 1NC 1NO - 1NC	2	51C202H	1	
	B = Indicator light, red, 120 V A = Indicator light, green, 120 V	NEMA 7/9	1NO - 1NC 1NO - 1NC	2	51C230H	1	
	C = Momentary flush pushbutton black, label "FORWARD" B = Momentary flush pushbutton black, label "REVERSE" A = Momentary raised pushbutton red, label "STOP"	NEMA 7/9	1NO - 1NC 1NO - 1NC 1NO - 1NC	3	51C301H	1	
	C = Momentary flush pushbutton black, label "OPEN" B = Momentary flush pushbutton black, label "CLOSE" A = Momentary raised pushbutton red, label "STOP"	NEMA 7/9	1NO - 1NC 1NO - 1NC 1NO - 1NC	3	51C303H	1	
	C = Indicator light, green, 120 V B = Momentary flush pushbutton black, label "START" A = Momentary raised pushbutton red, label "STOP"	NEMA 7/9	1NO - 1NC 1NO - 1NC	3	51C307H	1	

Enclosures only²⁾



For field assembly of Type 7 & 9 UL listed and cUL listed control stations. Devices may be installed for either horizontal or vertical mounting using a standard legend. Limited to depth of 1 contact block.

1	51EA1H	1
2	51EA2H	1
3	51EA3H	1

1) All enclosures come standard with one conduit entry on top. To get two conduit entries, append X-311 to the end of the order number.











2) For legend plates see page 10/177.

Pushbutton Units and Indicator Lights

Class 51, Hazardous Location NEMA Type 7 & 9 Devices

Accessories and spare parts

Selection and ordering data

Version	Suitable for	Conduit size (in.)	Color	Order No.	Pack Unit
	For small 1 5/8" (41.3mm) type, non-illuminated mushroom push-buttons		Black	52RB3D1	1
			Red	52RB3D2	
			Green	52RB3D3	
			Yellow	52RB3D4	
			Blue	52RB3D5	
			Gray	52RB3D6	
			Orange	52RB3D8	
			1 kit of each	52RB3DN	
				For large 2 1/2" (63.5mm) type, non-illuminated mushroom push-buttons	
Red	52RB3E2				
Green	52RB3E3				
Yellow	52RB3E4				
Blue	52RB3E5				
Gray	52RB3E6				
Orange	52RB3E8				
1 kit of each	52RB3EN				
	Replacement lens for pilot lights				Red
			Green	51RC4G3	
			Blue	51RC4G5	
			Amber	51RC4G9	
			Clear	51RC4GA	
	Replacement lens for push to test/illuminated pushbuttons		Red	51RC5G2	1
			Green	51RC5G3	
			Amber	51RC5G9	
	Guards		Chrome	51AAGM	1
Prevents accidental operation	Non-illuminated Pushbuttons & Push Pull Operators with Mushroom Head Caps 1 5/8" to 1 3/4" in diameter.				
	Lever inserts		Red	52RA2A2	1
			Green	52RA2A3	
			Blue	52RA2A4	
			Amber	52RA2A5	
			Gray	52RA2A6	
			Orange	52RA2A8	
			White	52RA2AB	
	Long lever		Red	52RA2B2	1
			Green	52RA2B3	
			Blue	52RA2B4	
			Amber	52RA2B5	
			Gray	52RA2B6	
			Orange	52RA2B8	
			White	52RA2BB	
	Padlock attachment	Only for raised pushbutton operators		51AAL	1
	Breather/drain (Stainless Steel)	Installs in bottom as a drain or in the top as a breather. Suitable for Class 1 groups C & D and for Class 2 groups F & G applications only. Fits 1/2" NPT.		51AADB	1
	Lock nut wrench	All devices		52MAWB	1
	Spare keys	550CH (1 key)		52KEY-550CH	1

Pushbutton Units and Indicator Lights

Class 51, Hazardous Location NEMA Type 7 & 9 Devices

Accessories and spare parts

1
2
3
4
5
6
7
8
9
10

Selection and ordering data



Version	Suitable for	Conduit size (in.)	Color	Order No.	Pack Unit			
Reducer bushings	Cast aluminum, UL recognized and CSA certified. Used to reduce existing tapered NPT conduit opening when required.	3/4 - 1/2		51AARBA	1			
		1 - 1/2		51AARCA				
		1 1/2 - 3/4		51AARDB				
		1 1/2 - 1		51AARDC				
		2 1/2 - 3/4		51AARFB				
		2 1/2 - 1		51AARFC				
		2 1/2 - 1 1/2		51AARFD				
		2 1/2 - 2		51AARFE				
		3 - 1		51AARGC				
		3 - 1 1/2		51AARGD				
		3 - 2		51AARGE				
		3 - 2 1/2		51AARGF				
Lamps with screw connection, miniature bayonet incandescent lamps								
		Flashing, type 267 lamp (replaces 755 lamp)	51, 52	6V	52AABNF	1		
		6V Full voltage, transformer type 755 lamp	51, 52	6V	52AABN	1		
		12V full voltage, type 756	51, 52	12V	52AACN	1		
		24V full voltage, 120/240V resistor push-to-test type 757	51, 52	24V	52AADN	1		
		Neon (uses resistors) type B2A (NE-51H)	51, 52	120V	52AAPN	1		
		120V, full voltage type 3S6/5	51, 52	120V	52AAENC	1		
		LEDs, Single element		51, 52	6V	Red	52AEB2	1
				51, 52	6V	Green	52AEB3	
				51, 52	6V	Yellow	52AEB4	
				51, 52	6V	White	52AEBB	
				51, 52	6V	Blue	52AEB5	
				51, 52	24V	Red	52AED2	
				51, 52	24V	Green	52AED3	
				51, 52	24V	Yellow	52AED4	
51, 52	24V			White	52AEDB			
51, 52	24V			Blue	52AED5			
51, 52	120V	Red	52AEE2					
51, 52	120V	Green	52AEE3					
51, 52	120V	Yellow	52AEE4					
51, 52	120V	White	52AEEB					
51, 52	120V	Blue	52AEE5					

Pushbutton Units and Indicator Lights

Class 51, Hazardous Location NEMA Type 7 & 9 Devices

Accessories and spare parts

Selection and ordering data

	Version	Suitable for	Conduit size (in.)	Color	Order No.	Pack Unit
	1 NO				52BAK	1
52BAJ	1 NC				52BAJ ^②	
	1 NO - 1 NC				52BJK ^②	
52BAK	1 NO early make	closes before 52BAK			52BAH	
	1 NC late break	opens after 52BAJ			52BAE	
52BAR	1 NO - 1 NC	Reed switch			52BAR ^①	
		UL listed for class 1 division 2				
		.25A Max, 200V AC, 10 Watt max				
		.5A Max, 200V DC, 10 Watt max				
	1 NC extra late break				52BAU	

① Hermetically sealed.

② ↻ Positive opening according to IEC 60947-5-1, Appendix K.

Pushbutton Units and Indicator Lights

30 mm Heavy Duty, Watertight/Oiltight, Class 52

Pushbutton complete units

Features

- Octagonal Mounting Nuts
- Meets Type 1, 3, 3R, 4, 4X, 12, 13 and Automotive Standards
- Heavy Duty Rated NEMA A600/P600 Contacts
-  Positively Driven Contacts
- Positive Indexing Selectors
- Bifurcated Movable Contacts
- Attractive Chrome Plating
- Boots Not Required for Type 4
- UL Listed File # E22655
- CSA Certified File # LR6535
- Touchsafe Terminals

Application

Oil tight pilot controls and accessories are designed to provide long, trouble free service in the most demanding industrial applications. These controls are oil and dust tight and meet Type 3, 4, 4X, 12 and 13 specifications.

Rugged

Industrial control operators are durable one piece castings. Heavy duty plastic buttons resist oils and corrosion. Silver contacts carry heavy duty ratings.

Flexible

Accessories modify standard push buttons, selector switches and pilot lights. Building block construction of contact blocks makes possible many circuitry combinations.

Industrial Appearance

Pilot controls add luster to panels. Chrome plating covers exposed metal parts.

Push Button Operators

The Operator Base consists of a durable, one piece casting equipped with a heavy duty actuator with a stainless steel spring, a neoprene actuator sealing ring to prevent oil and dust from penetrating to the contact blocks, a neoprene gasket to seal operator mounting hole and a chrome plated lock nut.

Mushroom Head Push Button Operators

The Mushroom Head base construction is identical to the push button base. The actuator is molded of high impact material for either a 1 5/8 inch or 2 1/2 inch diameter molded head.

E-STOP Mushroom Head Operators according to EN 60947-5-5 Cat. No. 52BP, 52BR, 52PP, and 52PR, 2 Position, Twist-To-Release & 2 Position, Push Pull Maintained operators provided with red operating heads and 52BJK contact blocks meet the requirements of EN 60947-5-5 for Electrical Emergency Stop Device With Mechanical Latching Function (e-stop).

Contact Blocks

Contact Blocks have double break bifurcated silver contacts, with gold flashing as standard, which improves contact reliability. Contact blocks are heavy duty rated NEMA A600 and suitable for applications down to 5V/1MA solid state outputs. 52BJK offers  Positive Opening Contacts according to IEC 60947-5-1, Appendix K. Molded bodies and pushers resist arcing and tracking. All units have stainless steel springs that resist corrosion and provide strong contact pressure. Captive mounting screws speed panel assembly.

Push Pull Operators

Push Pull Operators combine two or three functions in one unit. The maintained operator has two positions, typically pull to start, push to stop. The momentary operator with three positions provides spring return from both pull and push positions. In addition, a three position push maintained, pull momentary operator is available. The actuator come is 1 3/4 inch or 2 1/2 inch diameter and is available in an illuminated version.

2 Button Maintained Operator

Maintained Push Buttons consist of two push buttons and a latching assembly. When actuated the button remains depressed and is freed only by the release operator to which it is linked. The button assembly adjusts for mounting from a 1 13/16 inch to a 2 5/8 inch center.

Transformer Type Pilot Lights

Transformer Type Pilot Lights are available with a 120, 240, 480 or 600 Volt primary (50/60 Hertz) and a separate secondary winding which supplies reduced voltage to a miniature bayonet base 6 Volt lamp. These units are suitable for applications where vibration is present and long bulb life is desirable.

Full Voltage Type Pilot Lights

Full Voltage Pilot Lights are available for 6, 12, 24 and 120 Volt AC and DC applications.

Electrical Ratings

NEMA AC Ratings 50/60Hz
NEMA A600 10 Continuous Amps

Volts	Make	Break
120	60	6
240	30	3
480	15	1.5
600	12	1.2
VA	7200	720

Ordering Information

- Accessories: [pages 10/166 – 10/169](#)
- Selector Position and Contact Operation: [page 10/164 – 10/165](#).
- Legend Plates: [page 10/177](#).
- Enclosures: [page 10/178](#).
- Technical Specifications: [page 10/179](#).

Resistor Type Pilot Lights

Resistor Type Pilot Lights are available for 240 Volt AC and DC applications. The 240 Volt pilot light is supplied with a 120 Volt lamp and a voltage dropping resistor.

LED Type Pilot Lights

LED's (light emitting diodes) can be used in pilot lights instead of incandescent bulbs because of their long life (up to 10 years), resistance to vibration and ambient sensitivity. Clustered LED options are available for standard pilot lights only. Cluster LED options are not available on Push to test Pilot Lights, Illuminated Pushbuttons, Push-pull, or Twist-to-Release Operators.

Integrated LED Module Type Pilot Lights

The integrated LED module is available for 24, 120, and 240 V. LED modules are vibration resistant and have a long life (up to 10 years). The integrated LED module is available for 24, 120, and 240 V. LED modules are vibration resistant and have a long life (up to 10 yrs.).

Selector Operators

Selector Operators have positive action indexing. Operators are available with either a short or long lever. The molded black lever is designed to accept a color insert. A white insert is provided as standard. Each operator is equipped with a cam to actuate plungers of contact blocks assembled behind the operator. Two, three and four position operators are available with seven different cams.

Lever color inserts are available in 8 colors.



Indicator Light

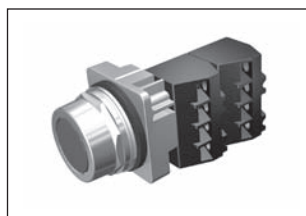

Push Button



Selector Switch



Selector Push Button

Push Buttons & Signaling Devices

30mm Water, Oil Tight & Corrosion Resistant – Class 52

Push Button

Selection Guide

Momentary Push Button - Non-Illuminated

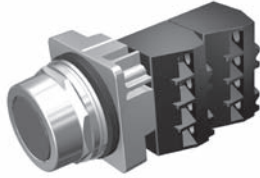

Flush Head



Extended Head

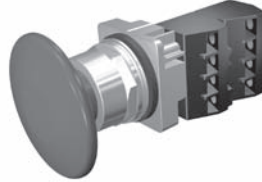

Large Mushroom Head 2 1/2"



Small Mushroom Head 1 3/4"

Part Number	52	<u> </u>	<u> </u>	<u> </u>	<u> </u>	<u> </u>
		a	M	c	d	e¹
			b			

a	Code	Finish
	P	Chrome - Command 52
	B	Epoxy Coated - Black Max

b	Code	Type
	M	Momentary Push Button

c	Code	Style / Head Type
	Flush / Extended Cap	
	8A	Flush
	8B	Extended
	Mushroom Head Metal	
	9A	Small Mushroom Head 1 3/4" (44.5mm)
	Mushroom Head Plastic	
	9W	Small Mushroom Head 1 3/4" (44.5mm)
	9V	Large Mushroom Head 2 1/2" (63.5mm)

d	Code	Plastic	Metal
	1	Black	—
	2	Red	Red
	3	Green	Green
	4	Yellow	—
	5	Blue	—
	6	Gray	—
	7	All Color Caps	—
	8	Orange	—
C	—	Chrome	

e¹	Code	Contact Blocks
	A	1 NO + 1 NC
	B	2 NO + 2 NC
	C	3 NO + 3 NC
	D	4 NO + 4 NC
	E	1 NC (LB)
	F	2 NO
	G	2 NC
	H	1NO (EM)
	J	1 NC
	K	1 NO

¹ For operator without contact blocks leave position e blank.

Push Buttons & Signaling Devices

30mm Water, Oil Tight & Corrosion Resistant – Class 52

Push Buttons

1

2

3

4

5

6

7

8

9

10

Selection Tables

Momentary Push Button - Non-Illuminated

Head Style	Contacts	Color	Finish		
			Chrome	Black Max	
Flush	—	Less cap	52PM8	52BM8	
		Black	52PM8A1	52BM8A1	
		Red	52PM8A2	52BM8A2	
		Green	52PM8A3	52BM8A3	
		Yellow	52PM8A4	52BM8A4	
	1 NO - 1 NC	Black	52PM8A1A	52BM8A1A	
		Red	52PM8A2A	52BM8A2A	
		Green	52PM8A3A	52BM8A3A	
	1 NO	Black	52PM8A1K	52BM8A1K	
		Red	52PM8A2K	52BM8A2K	
		Green	52PM8A3K	52BM8A3K	
	1 NC	Red	52PM8A2J	52BM8A2J	
	Extended	—	Black	52PM8B1	52BM8B1
			Red	52PM8B2	52BM8B2
			Green	52PM8B3	52BM8B3
1 NO		Black	52PM8B1K	52BM8B1K	
		Red	52PM8B2K	52BM8B2K	
1 NC		Red	52PM8B2J	52BM8B2J	
Mushroom Head Plastic Ø 1 3/4"	—	Less cap	52PM9	52BM9	
		Red	52PM9W2	52BM9W2	
	1 NO	Green	52PM9W3K	52BM9W3K	
	1 NO - 1 NC	Black	52PM9W1A	52BM9W1A	
		Red	52PM9W2A	52BM9W2A	
	1 NO - 1 NC	Green	52PM9W3A	52BM9W3A	
Mushroom Head Plastic Ø 2 1/2"	—	Red	52PM9V2	52BM9V2	
		Black	52PM9V1A	52BM9V1A	
	1 NO - 1 NC	Red	52PM9V2A	52BM9V2A	
		Green	52PM9V3A	52BM9V3A	

Readily available items are in **bold**.
This is a small representation of stocked items.

Push Buttons & Signaling Devices

30mm Water, Oil Tight & Corrosion Resistant – Class 52

Non-Illuminated Push Pull

Selection Guide

2 & 3 Position Push-Pull Mushroom Head Devices - Non-Illuminated

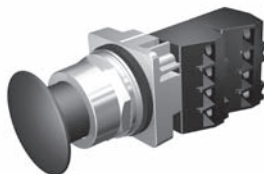

Mushroom Head Metal Ø 1 3/4"



Mushroom Head Plastic Ø 2 1/2"

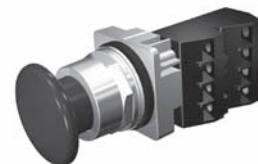

Mushroom Head Plastic Ø 1 3/4"

Part Number	52	<u> </u>	P	<u> </u>	<u> </u>	<u> </u>	<u> </u>
		a	b	c	d	e	f³

a	Code	Finish
	P	Chrome-Command 52
	B	Epoxy Coated-Black Max

b	Code	Type
	P	Push Pull

c	Code	Function
	2	2 positions - maintained ¹
	3	3 positions - momentary in - momentary out
	7	3 positions - maintained in - momentary out

d	Code	Style
	A	Small metal 1-3/4" (44.5 mm)
	W	Small plastic 1-3/4" (44.5 mm)
	V	Large plastic 2-1/2" (63.5 mm)

e	Code	Color	
		Plastic	Metal
	1	Black	—
	2	Red ¹	Red ¹
	3	Green	Green
	4	Yellow	—
	5	Blue	—
	6	Gray	—
	8	Orange	—
	C	—	Chrome
		No Operating Head	
	Z	No head	

f³	Code	Contact Blocks
		2 Position
	A	1 NO + 1 NC ¹
	B	2 NO + 2 NC ¹
	C	3 NO + 3 NC ¹
	D	4 NO + 4 NC ¹
	E	1 NC (LB)
	F	2 NO
	G	2 NC ¹
	H	1 NO (EM)
	J	1 NC ¹
	K	1 NO
	Q	1 NO - 1 NC (ELB)
		3 Position
	U	1 NO - 1 NC extra late break ²

¹ EMERGENCY-STOP control devices according to IEC 60947-5-5 when provided with red operating head and positively driven NC contact blocks. Positive opening contacts according to IEC 60947-5-1, Appendix K.

² Blocks cannot be interchanged (stop-start circuit - pull to start, push to stop).

³ For operator without contact blocks leave position f blank.

Push Buttons & Signaling Devices

30mm Water, Oil Tight & Corrosion Resistant – Class 52

Non-Illuminated Push Pull

Selection Tables

2 & 3 Position Push-Pull Mushroom Head Devices - Non-Illuminated

		2 pos - maintained					
		Metal Ø 1 3/4"		Plastic Ø 1 3/4"		Plastic Ø 2 1/2"	
Contacts	Color	Chrome	Black Max	Chrome	Black Max	Chrome	Black Max
—	Black	—	—	52PP2W1	52BP2W1	52PP2V1	2BP2V1
	Red	52PP2A2	52BP2A2	52PP2W2	52BP2W2	52PP2V2	52BP2V2
	Green	52PP2A3	52BP2A3	52PP2W3	52BP2W3	52PP2V3	52BP2V3
	Yellow	—	—	52PP2W4	52BP2W4	52PP2V4	52BP2V4
1 NO - 1 NC	Red	52PP2A2A¹	52BP2A2A¹	52PP2W2A¹	52BP2W2A¹	52PP2V2A¹	52BP2V2A ¹
	Green	52PP2A3A	52BP2A3A	52PP2W3A	52BP2W3A	52PP2V3A	—
	Yellow	—	—	52PP2W4A	52BP2W4A	52BP2V4A	52BP2V4A
	Chrome	52PP2ACA	52BP2ACA	—	—	—	—

		3 pos - momentary in - momentary out					
		Metal Ø 1 3/4"		Plastic Ø 1 3/4"		Plastic Ø 2 1/2"	
Contacts	Color	Chrome	Black Max	Chrome	Black Max	Chrome	Black Max
—	Black	—	—	52PP3W1	52BP3W1	52PP3V1	52BP3V1
	Red	52PP3A2	52BP3A2	52PP3W2	52BP3W2	52PP3V2	52BP3V2
	Green	52PP3A3	52BP3A3	52PP3W3	52BP3W3	52PP3V3	2BP3V3
	Chrome	52PP3AC	52BP3AC	—	—	—	—
1 NO - 1 NCELB	Red	52PP3A2U	52BP3A2U	52PP3W2U	52BP3W2U	52PP3V2U	52BP3V2U
	Green	52PP3A3U	52BP3A3U	52PP3W3U	52BP3W3U	52PP3V3U	52BP3V3U

		3 pos - maintained in - momentary out					
		Metal Ø 1 3/4"		Plastic Ø 1 3/4"		Plastic Ø 2 1/2"	
Contacts	Color	Chrome	Black Max	Chrome	Black Max	Chrome	Black Max
—	Black	—	—	52PP7W1	52BP7W1	52PP7V1	52BP7V1
	Red	52PP7A2	52BP7A2	52PP7W2	52BP7W2	52PP7V2	52BP7V2
	Green	52PP7A3	52BP7A3	52PP7W3	52BP7W3	52PP7V3	52BP7V3
	Chrome	52PP7AC	52BP7AC	—	—	—	—
1 NO - 1 NCELB	Red	52PP7A2U1	52BP7A2U	52PP7W2U	52BP7W2U	52PP7V2U	52BP7V2U
	Green	52PP7A3U	52BP7A3U	52PP7W3U	52BP7W3U	52PP7V3U	52BP7V3U

Readily available items are in **bold**.
This is a small representation of stocked items.

¹ EMERGENCY-STOP control devices according to IEC 60947-5-5

Push Buttons & Signaling Devices

30mm Water, Oil Tight & Corrosion Resistant – Class 52

Illuminated Push Pull & Push Button

Selection Guide

2 & 3 Position Push-Pull Mushroom Head Devices - Illuminated

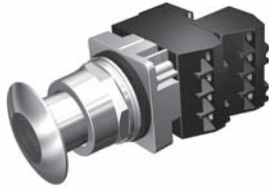

Mushroom Head Metal Ø 1 3/4"



Mushroom Head Plastic Ø 2 1/2"

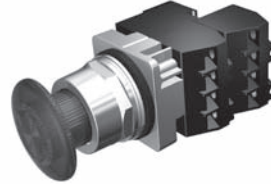

Mushroom Head Plastic Ø 1 3/4"

Part Number	52	a	P	c	d	e	f	g
-------------	-----------	----------	----------	----------	----------	----------	----------	----------

a	Code	Finish
	P	Chrome-Command 52
	B	Epoxy Coated-Black Max

b	Code	Type
	P	Push Pull Operator

c	Code	Function
	2	2 positions - maintained ¹
	3	3 positions - momentary in - momentary out ²
	7	3 positions - maintained in - momentary out ²

d	Code	Operation	
		Full Voltage ³ (AC/DC)	
		Incandescent	LED ⁴
	B	6-8V	6V
	C	12-13V	—
	D	24-28V	24-28V
	E	120V	120V
	F	240V	240V
		Transformer ³	
	G	120V AC	
	H	240V AC	
	J	480V AC	
	K	600V AC	

e	Code	Style / Color
		Mushroom Head Metal Ø 1 3/4" (44.5mm)
	2	Red ¹
	3	Green
	5	Blue
	9	Amber
	A	Clear
	B	White
		Mushroom Head Plastic Ø 1 3/4" (44.5 mm)
	R	Red ¹
	S	Green
	T	Amber
		Mushroom Head Plastic Ø 2 1/2" (63.5mm)
	D	Red ¹
	E	Green
	F	Amber
		No Head (full voltage & transformer only)
	Z	No head

f	Code	Contact Blocks
		2 Position
	A	1 NO + 1 NC ¹
	B	2 NO - 2 NC ¹
	F	2 NO
	G	2 NC ¹
	J	1 NC ¹
	K	1 NO
	Q	1 NO - 1 NC (ELB)
		3 Position
	U	1 NO - 1 NC extra late break ²

g	Code	Bulb Type
	Blank	Incandescent
	B	LED
	Y	Super-Bright LED

¹ EMERGENCY-STOP control devices according to IEC 60947-5-5 when provided with red operating head and positively driven NC contact blocks.

Positive opening contacts according to IEC 60947-5-1, Appendix K,

² Blocks cannot be interchanged (stop-start circuit - pull to start, push to stop).

³ Default bulb type is incandescent. For LED options, append field g. LED option not available on units sold "no head".

⁴ LED voltages apply to table g option code B and Y.
6V and 120V are currently AC only. Replaced by AC/DC rated versions end of 2014.

Push Buttons & Signaling Devices

30mm Water, Oil Tight & Corrosion Resistant – Class 52

Illuminated Push Pull

1
2
3
4
5
6
7
8
9
10

Selection Tables

Type	Lamp Type	Voltage	Color	Contacts
Full Voltage (AC/DC)	LED	24V	Red	1 NO - 1 NC
			Green	1 NO - 1 NC
	Incandescent	24V	Red	1 NO - 1 NC
			Green	1 NO - 1 NC
		120V	Red	1 NO - 1 NC
			—	—
Transformer (AC)	LED	120V	Red	1 NO - 1 NC
			Green	1 NO - 1 NC
	Incandescent	120V	Red	1 NO - 1 NC
			Green	1 NO - 1 NC

Operator Type			
2 pos - maintained			
Metal Ø 1 3/4"		Plastic Ø 1 3/4"	
Chrome	Black Max	Chrome	Black Max
52PP2D2AB¹	52BP2D2AB¹	52PP2DRAB¹	52BP2DRAB¹
52PP2D3AB	52BP2D3AB	52PP2DSAB	52BP2DSAB
52PP2D2A¹	52BP2D2A¹	52PP2DRA¹	52BP2DRA¹
52PP2D3A	52BP2D3A	52PP2DSA	52BP2DSA
52PP2E2A ¹	52BP2E2A ¹	52PP2ERA ¹	52BP2ERA ¹
52PP2E2	52BP2E2	52PP2ER	52BP2ER
52PP2G2AB¹	52BP2G2AB¹	52PP2GRAB¹	52BP2GRAB¹
52PP2G3AB	52BP2G3AB	52PP2GSAB	52BP2GSAB
52PP2G2A¹	52BP2G2A¹	52PP2GRA¹	52BP2GRA¹
52PP2G3A	52BP2G3A	52PP2GSA	52BP2GSA

Type	Lamp Type	Voltage	Color	Contacts
Full Voltage (AC/DC)	LED	24V	Green	1 NO - 1 NCELB
			Green	1 NO - 1 NCELB
	Incandescent	24V	Red	1 NO - 1 NCELB
			Red	—
		120V	Red	—
			—	—
Transformer (AC)	LED	120V	Red	1 NO - 1 NCELB
			Green	1 NO - 1 NCELB
	Incandescent	120V	Red	1 NO - 1 NCELB
			Green	1 NO - 1 NCELB

Operator Type			
3 pos - momentary in - momentary out			
Metal Ø 1 3/4"		Plastic Ø 1 3/4"	
Chrome	Black Max	Chrome	Black Max
52PP3D3UB	52BP3D3UB	52PP3DRUB	52BP3DRUB
52PP3D3U	52BP3D3U	52PP3DSU	52BP3DSU
52PP3D2U	52BP3D2U	52PP3DRU	52BP3DRU
52PP3E2	52BP3E2	52PP3ER	52BP3ER
52PP3G2UB	52BP3G2UB	52PP3GRUB	52BP3GRUB
52PP3G3UB	52BP3G3UB	52PP3GSUB	52BP3GSUB
52PP3G2U	52BP3G2U	52PP3GRU	52BP3GRU
52PP3G3U	52BP3G3U	52PP3GRU	52BP3GRU

Type	Lamp Type	Voltage	Color	Contacts
Full Voltage (AC/DC)	LED	24V	Green	1 NO - 1 NCELB
			Green	1 NO - 1 NCELB
	Incandescent	24V	Red	1 NO - 1 NCELB
			Red	—
		120V	Red	—
			—	—
Transformer (AC)	LED	120V	Red	1 NO - 1 NCELB
			Green	1 NO - 1 NCELB
	Incandescent	120V	Red	1 NO - 1 NCELB
			Green	1 NO - 1 NCELB

Operator Type			
3 pos - maintained in - momentary out			
Metal Ø 1 3/4"		Plastic Ø 1 3/4"	
Chrome	Black Max	Chrome	Black Max
52PP7D3UB	52BP7D3UB	52PP7DSUB	52BP7DSUB
52PP7D3U	52BP7D3U	52PP7DSU	52BP7DSU
52PP7D2U	52BP7D2U	52PP7DRU	52BP7DRU
52PP7E2	52BP7E2	52PP7ER	52BP7ER
52PP7G2UB	52BP7G2UB	52PP7GRUB	52BP7GRUB
52PP7G3UB	52BP7G3UB	52PP7GSUB	52BP7GSUB
52PP7G2U	52BP7G2U	52PP7GRU	52BP7GRU
52PP7G3U	52BP7G3U	52PP7GRU	52BP7GRU

Readily available items are in **bold**.
This is a small representation of stocked items.

¹ EMERGENCY-STOP control devices according to IEC 60947-5-5

Push Buttons & Signaling Devices

30mm Water, Oil Tight & Corrosion Resistant – Class 52

Non-Illuminated Twist-to-Release

Selection Guide

2 Position Twist-to-Release Devices Mushroom Head - Non-Illuminated

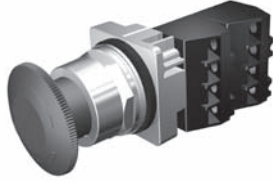

Plastic 1 3/4" Mushroom Head - Chrome



Plastic 1 3/4" Mushroom Head - Black Max

Part Number	52	<u> </u> a	<u> </u> R b	<u> </u> 8 c	<u> </u> W d	<u> </u> e	<u> </u> f²
--------------------	-----------	-------------------------	-------------------------------------	-------------------------------------	-------------------------------------	-------------------------	-------------------------------------

Finish	Function	Style	Color	Contacts	Part Number
Chrome	2 Position Twist-to-Release	Plastic 1 3/4" Mushroom Head	Red	1 NO - 1 NC	52PR8W2A
Black Max	2 Position Twist-to-Release	Plastic 1 3/4" Mushroom Head	Red	1 NO - 1 NC	52BR8W2A
Chrome	2 Position Twist-to-Release	Plastic 1 3/4" Mushroom Head	Red	None	52PR8W2

Readily available items are in **bold**.
This is a small representation of stocked items.

a	Code	Finish
	P	Chrome-Command 52
	B	Epoxy Coated-Black Max
b	Code	Function
	R	2 Position Twist-to-Release, Maintained ¹
c	Code	Style
	8	Plastic 1 3/4" Mushroom Head
d	Code	Lamp Type
	W	Non-Illuminated

e	Code	Color
	2	Red ¹
	3	Green
	4	Yellow
	Z	No head
f²	Code	Contact Blocks
	A	1 NO + 1 NC ¹
	B	2 NO + 2 NC ¹
	C	3 NO + 3 NC ¹
	D	4 NO + 4 NC ¹
	E	1 NC (LB)
	F	2 NO
	G	2NC ¹
	H	1NO (EM)
	J	1 NC ¹
	K	1 NO

¹ EMERGENCY-STOP control devices according to IEC 60947-5-5 when provided with red operating head and positively driven NC contact blocks. Positive opening contacts according to IEC 60947-5-1, Appendix K.

² For operator without contact blocks leave position f blank.

Push Buttons & Signaling Devices

30mm Water, Oil Tight & Corrosion Resistant – Class 52

Illuminated Twist-to-Release

1
2
3
4
5
6
7
8
9
10

Selection Guide

2 Position Twist-to-Release Mushroom Head Devices - Illuminated

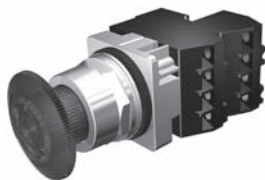

Plastic 1 3/4" Mushroom Head - Chrome



Plastic 1 3/4" Mushroom Head - Black Max

Part Number	52	a	R	8	d	e	f	g
-------------	-----------	----------	----------	----------	----------	----------	----------	----------

Finish	Style	Voltage	Bulb Type	Color	Contacts	Part Number
Chrome	Plastic 1 3/4" Mushroom Head	24V	LED	Red	1 NO - 1 NC	52PR8DRAB
Chrome	Plastic 1 3/4" Mushroom Head	120V	Incandescent	Red	1 NO - 1 NC	52PR8ERA
Chrome	Plastic 1 3/4" Mushroom Head	120V	LED	Red	1 NO - 1 NC	52PR8GRAB

Readily available items are in **bold**.
This is a small representation of stocked items.

a	Code	Finish
	P	Chrome-Command 52
	B	Epoxy Coated-Black Max

b	Code	Function
	R	2 Position Twist-to-Release, Maintained

c	Code	Style
	8	Plastic 1 3/4" Mushroom Head

d	Code	Operation	
		Full Voltage ² (AC/DC)	
		Incandescent	LED ³
	B	6-8V	6V
	C	12-13V	—
	D	24-28V	24-28V
	E	120V	120V
	F	240V	240V
		Transformer ²	
	G	120V AC	
	H	240V AC	
	J	480V AC	
	K	600V AC	

e	Code	Color
	R	Red ¹
	S	Green
	T	Amber
	Z	No head

f	Code	Contact Blocks
	A	1 NO + 1 NC ¹
	B	2 NO + 2 NC ¹
	C	3 NO + 3 NC ¹
	D	4 NO + 4 NC ¹
	E	1 NC (LB)
	F	2 NO
	G	2NC ¹
	H	1NO (EM)
	J	1 NC ¹
K	1 NO	

g	Code	Bulb Type
	Blank	Incandescent
	B	LED
	Y	Super-Bright LED

¹ EMERGENCY-STOP control devices according to IEC 60947-5-5 when provided with red operating head and positively driven NC contact blocks. Positive opening contacts according to IEC 60947-5-1, Appendix K, Molded bodies.

² Default bulb type is incandescent. For LED options, append field g. LED option not available on units sold "no head."

³ LED voltages apply to table g option code B and Y. 6V and 120V are currently AC only. Replaced by AC/DC rated versions end of 2014.

Push Buttons & Signaling Devices

30mm Water, Oil Tight & Corrosion Resistant – Class 52

Indicator Light

Selection Guide

Indicator Light



Plastic Lens



Glass Lens

Part Number	52	<u> </u> a	<u> </u> L b	<u> </u> c	<u> </u> d	<u> </u> e	<u> </u> f
-------------	-----------	-------------------------	-------------------------------------	-------------------------	-------------------------	-------------------------	-------------------------

a	Code	Finish
	P	Chrome-Command 52
	B	Epoxy Coated-Black Max

b	Code	Type
	L	Indicator Light

c	Code	Style
	4	Plastic Lens
	5	Glass Lens

d	Code	Operation	
		Full Voltage ¹ (AC/DC)	
		Incandescent	LED ²
	B	6-8V	6V
	C	12-13V	—
	D	24-28V	24-28V
	E	120V	120V
	F	240V	240V
		Transformer ¹	
	G	120V AC	
	H	240V AC	
	J	480V AC	
	K	600V AC	

e	Code	Color
	2	Red
	3	Green
	5	Blue
	7	All Colors
	9	Amber
	A	Clear
	B	White
	N	No Lens

f	Code	Bulb Type
	Blank	Incandescent
	XB	LED
	XY	Super-Bright LED

¹ Default bulb type is incandescent. For LED options, append field f.
LED option not available on units sold "No Lens".

² LED voltages apply to table f option code XB and XY.
6V, 24V (Super Bright only) and 120V are currently AC only. Replaced by AC/DC rated versions end of 2014.

Push Buttons & Signaling Devices

30mm Water, Oil Tight & Corrosion Resistant – Class 52

Indicator Lights

1
2
3
4
5
6
7
8
9
10

Selection Tables

Indicator Light

Type	Lamp Type	Voltage	Color	Plastic Lens		
				Chrome	Black Max	
Full Voltage (AC/DC)	LED	24V	Red	52PL4D2XB	52BL4D2XB	
			Green	52PL4D3XB	52BL4D3XB	
			Blue	52PL4D5XB	52BL4D5XB	
			Amber	52PL4D9XB	52BL4D9XB	
			White	52PL4DBXB	52BL4DBXB	
		120V	Red	52PL4E2XB	52BL4E2XB	
			Green	52PL4E3XB	52BL4E3XB	
			Amber	52PL4E9XB	52BL4E9XB	
			Clear	52PL4EAXB	52BL4EAXB	
			White	52PL4EBXB	52BL4EBXB	
	Incandescent	24V	Red	52PL4D2	52BL4D2	
			Green	52PL4D3	52BL4D3	
			Blue	52PL4D5	52BL4D5	
			Amber	52PL4D9	52BL4D9	
			White	52PL4DB	52BL4DB	
		120V	No Lens	52PL4DN	52BL4DN	
			Red	52PL4E2	52BL4E2	
			Green	52PL4E3	52BL4E3	
			Amber	52PL4E9	52BL4E9	
			No Lens	52PL4EN	52BL4EN	
Transformer (AC)	LED	120V	Red	52PL4G2XB	52BL4G2XB	
			Green	52PL4G3XB	52BL4G3XB	
			Amber	52PL4G9XB	52BL4G9XB	
			White	52PL4GBXB	52BL4GBXB	
		480V	Red	52PL4J2XB	52BL4J2XB	
			Green	52PL4J3XB	52BL4J3XB	
			White	52PL4JBXB	52BL4JBXB	
			Red	52PL4G2	52BL4G2	
			Green	52PL4G3	52BL4G3	
			Amber	52PL4G9	52BL4G9	
	Incandescent	120V	White	52PL4GB	52BL4GB	
			No Lens	52PL4GN	52BL4GN	
			Red	52PL4H2	52BL4H2	
			Green	52PL4H3	52BL4H3	
			Red	52PL4J2	52BL4J2	
		240V	Green	52PL4J3	52BL4J3	
			480V	Red	52PL4J9	52BL4J9
				Green		
				Amber		

Readily available items are in **bold**.
This is a small representation of stocked items.

Push Buttons & Signaling Devices

30mm Water, Oil Tight & Corrosion Resistant – Class 52

Illuminated Push Button & Push-to-Test

Selection Guide

Push Button & Push-to-Test - Illuminated

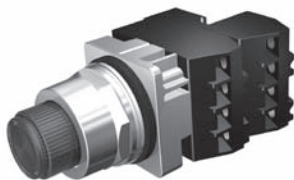

Extended Lens



Flush Lens

Part Number	52	<u> </u>	<u> </u> T	<u> </u>	<u> </u>	<u> </u>	<u> </u>	<u> </u>
		a	b	c	d	e	f	g

a	Code	Finish
	P	Chrome-Command 52
	B	Epoxy Coated-Black Max

b	Code	Function
	T	Illuminated Push Button / Push-to-Test ¹

c	Code	Style
	6	Extended Lens
	8	Flush Lens ²

d	Code	Operation	
		Full Voltage ³ (AC/DC)	
		Incandescent	LED ⁴
	B	6-8V	6V
	C	12-13V	—
	D	24-28V	24-28V
	E	120V	120V
	F	240V	240V
		Transformer ³	
	G	120V AC	
	H	240V AC	
	J	480V AC	
	K	600V AC	

e	Code	Color
	2	Red
	3	Green
	5	Blue
	7	All Colors
	9	Amber
	A	Clear
	B	White
	N	No Lens

f	Code	Contact Blocks
	A	1 NO - 1 NC
	B	2 NO + 2 NC
	C	3 NO + 3 NC
	D	4 NO + 4 NC
	E	1 NC (LB)
	F	2 NO
	G	2 NC
	H	1NO (EM)
	J	1 NC
	K	1 NO

g	Code	Bulb Type
	Blank	Incandescent
	B	LED
	Y	Super-Bright LED

1 For push-to-test functionality, wire according to wiring diagram below.
2 Products available early 2014.

Wiring Diagrams

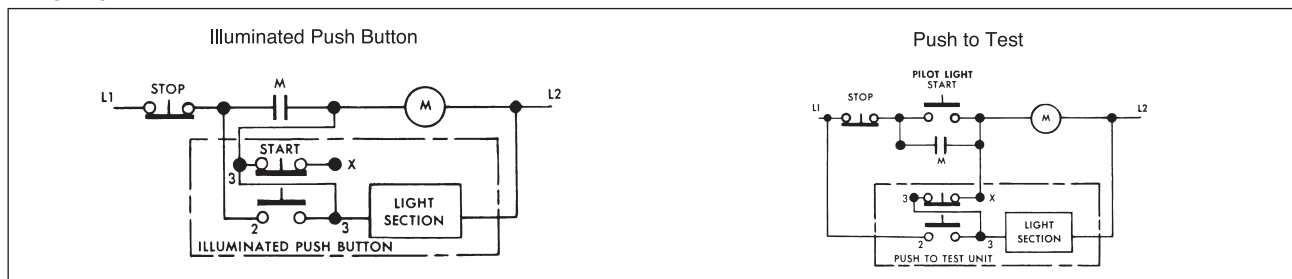

3 Default bulb type is incandescent. For LED options, append field g.
LED option not available on units sold "No Lens".
4 LED voltages apply to table g option code B and Y.
6V and 120V are currently AC only. Replaced by AC/DC rated versions end of 2014.

Push Buttons & Signaling Devices

30mm Water, Oil Tight & Corrosion Resistant – Class 52

Illuminated Push Buttons & Push-to-Test

Selection Tables

Push Button & Push-to-Test - Illuminated

Type	Lamp Type	Voltage	Color	Contacts	Extended Lens	
					Chrome	Black Max
Full Voltage (AC/DC)	LED	24V	Red	1 NO - 1 NC	52PT6D2AB	52BT6D2AB
			Green	1 NO - 1 NC	52PT6D3AB	52BT6D3AB
			Blue	1 NO - 1 NC	52PT6D5AB	52BT6D5AB
			Amber	1 NO - 1 NC	52PT6D9AB	52BT6D9AB
			White	1 NO - 1 NC	52PT6DBAB	52BT6DBAB
	Incandescent	24V	Red	1 NO - 1 NC	52PT6D2A	52BT6D2A
			Green	1 NO - 1 NC	52PT6D3A	52BT6D3A
			Blue	1 NO - 1 NC	52PT6D5A	52BT6D5A
			Amber	1 NO - 1 NC	52PT6D9A	52BT6D9A
			White	1 NO - 1 NC	52PT6DBA	52BT6DBA
Transformer (AC)	LED	120V	Red	1 NO - 1 NC	52PT6G2AB	52BT6G2AB
			Green	1 NO - 1 NC	52PT6G3AB	52BT6G3AB
			Amber	1 NO - 1 NC	52PT6G9AB	52BT6G9AB
			White	1 NO - 1 NC	52PT6GBAB	52BT6GBAB
			Incandescent	120V	Red	1 NO - 1 NC
	Green	1 NO - 1 NC			52PT6G3A	52BT6G3A
	Amber	1 NO - 1 NC			52PT6G9A	52BT6G9A
	White	1 NO - 1 NC			52PT6GBA	52BT6GBA
	No Lens	1 NO - 1 NC			52PT6GNA	52BT6GNA
	Incandescent	240V	Green	1 NO - 1 NC	52PT6H3A	52BT6H3A
480V		Clear	1 NO - 1 NC	52PT6JAA	52BT6JAA	

Readily available items are in **bold**.
This is a small representation of stocked items.

Push Buttons & Signaling Devices

30mm Water, Oil Tight & Corrosion Resistant – Class 52

Illuminated Push Button

Selection Guide

Push Button Mushroom Head Devices – Illuminated

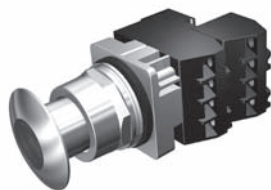

Mushroom Head Metal Ø 1 3/4"



Mushroom Head Plastic Ø 2 1/2"

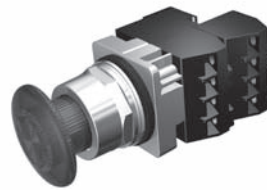

Mushroom Head Plastic Ø 1 3/4"

Part Number	52	a	T	9	d	e	f	g
-------------	-----------	----------	----------	----------	----------	----------	----------	----------

a	Code	Finish
	P	Chrome-Command 52
	B	Epoxy Coated-Black Max

b	Code	Type
	T	Push Button Operator

c	Code	Function
	9	2 positions – momentary in

d	Code	Operation
		Full Voltage² (AC/DC)
		Incandescent LED³
	B	6-8V 6V
	C	12-13V —
	D	24-28V 24-28V
	E	120V 120V
	F	240V 240V
		Transformer²
	G	120V AC
	H	240V AC
	J	480V AC
	K	600V AC

e	Code	Style / Color
		Mushroom Head Metal Ø 1 3/4" (44.5mm)
	2	Red ¹
	3	Green
	5	Blue
	9	Amber
	A	Clear
	B	White
		Mushroom Head Plastic Ø 1 3/4" (44.5 mm)
	R	Red
	S	Green
	T	Amber
		Mushroom Head Plastic Ø 2 1/2" (63.5mm)
	D	Red ¹
	E	Green
	F	Amber
		No Head (full voltage & transformer only)
	Z	No head

f	Code	Contact Blocks
	A	1 NO + 1 NC
	B	2 NO + 2 NC
	C	3 NO + 3 NC
	D	4 NO + 4 NC
	E	1 NC (LB)
	F	2 NO
	G	2 NC
	H	1NO (EM)
	J	1 NC
	K	1 NO

g	Code	Bulb Type
	Blank	Incandescent
	B	LED
	Y	Super-Bright LED

1 Positive opening according to IEC 60947-5-1, Appendix K.

2 Default bulb type is incandescent. For LED options, append field g. LED option not available on units sold "no head".

3 LED voltages apply to table g option code B and Y.
6V and 120V are currently AC only. Replaced by AC/DC rated versions end of 2014.

Push Buttons & Signaling Devices

30mm Water, Oil Tight & Corrosion Resistant – Class 52

Illuminated Selector Switches

1
2
3
4
5
6
7
8
9
10

Selection Guide

Selector Switches – Illuminated

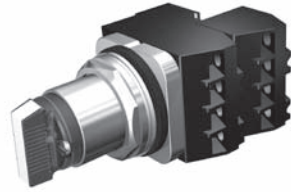

Short Lever – Chrome



Short Lever – Black Max

Part Number	52	S		7					
		a	b	c	d	e	f	g	h

Finish	Style	Cam Type	Function	Color	Contacts	Part Number
Chrome	Maintained	2 Position: CAM A	24-28V AC/DC	No Insert	None	52SA7ADN
Chrome	Maintained	2 Position: CAM A	120V AC (Transformer)	No Insert	None	52SA7AGN
Chrome	Maintained	3 Position: CAM C	120V AC	No Insert	None	52SA7CGN

Readily available items are in **bold**.
This is a small representation of stocked items.

a	Code	Type
	S	Selector Switch

b	Code	Finish
	A	Chrome - Command 52
	X	Epoxy Coated - Black Max

c	Code	Style
	7	Maintained

d	Code	Function
	A	2 Position: CAM A
	B	3 Position: CAM B
	C	3 Position: CAM C

e	Code	Operation	
		Full Voltage ¹ (AC/DC)	
		Incandescent	LED ²
	B	6-8V	6V
	C	12-13V	—
	D	24-28V	24-28V
	E	120V	120V
	F	240V	240V
		Transformer ¹	
	G	120V AC	
	H	240V AC	
	J	480V AC	
	K	600V AC	

¹ Default bulb type is incandescent. For LED options, append field i.
LED option not available on units sold "no head".

² LED voltages apply to table i option code B and Y.
6V and 120V are currently AC only. Replaced by AC/DC rated versions end of 2014.

For CAM selection see page 10/164.

f	Code	Color
	2	Red
	3	Green
	5	Blue
	9	Amber
	A	Clear
	N	No Insert

g	Code	Contact Blocks
	A	1 NO - 1 NC
	E	1 NC (LB)
	H	1 NO (EM)
	J	1 NC
	K	1 NO

h	Code	Contact Quantity & Location	
		Left	Right
	0	1	—
	1	—	1
	2	1	1
	3	2	—
	4	—	2
	5	2	1
	6	1	2
	7	2	2
	8	3	—
	9	—	3

i	Code	Bulb Type
	Blank	Incandescent
	B	LED
	Y	Super-Bright LED

Push Buttons & Signaling Devices

30mm Water, Oil Tight & Corrosion Resistant – Class 52

Non-Illuminated Selector Switch

Selection Guide

Keyed Selector Switch



Short Lever



Long Lever

Part Number	52	S	2					
	a	b	c	d	e	f	g²	h²

a	Code	Type
	S	Selector Switch

b	Code	Finish
	A	Chrome - Short Lever
	B	Chrome - Long Lever
	X	BlackMax - Short Lever
	W	BlackMax - Long Lever

c	Code	Style
	2	Non-Illuminated

d	Code	Function
	A	2 Position: CAM A
	B	3 Position: CAM B
	C	3 Position: CAM C ¹
	D	3 Position: CAM D
	E	3 Position: CAM E
	G	3 Position: CAM G
	H	4 Position: CAM H

e	Code	Type
		2 Position
		Maintained Spring Return
	A	All —
	C	Left Right
		3 Position
		Maintained Spring Return
	A	All —
	B	Center, Right Left
	C	Center, Left Right
	D	Center Left, Right
		4 Position
		Maintained Position Spring Return
	A	All —

f	Code	Color
	2	Red
	3	Green
	4	Yellow
	5	Blue
	6	Gray
	8	Orange
	B	White
	N	No Insert (Black)

g ²	Code	Contact Blocks
	A	1 NO - 1 NC
	E	1 NC (LB)
	H	1 NO (EM)
	J	1 NC
	K	1 NO

h ²	Code	Contact Quantity & Location	
		Left	Right
	0	1	—
	1	—	1
	2	1	1
	3	2	—
	4	—	2
	5	2	1
	6	1	2
	7	2	2
	8	3	—
	9	—	3

1 C CAM on spring return selectors is limited to 4 contact blocks.
For CAM selection see page 10/164.

2 For operator without contact blocks leave positions g and h blank.

Push Buttons & Signaling Devices

30mm Water, Oil Tight & Corrosion Resistant – Class 52

Non-Illuminated Selector Switch

1
2
3
4
5
6
7
8
9
10

Selector Switch, Non-Illuminated¹⁾

Contact Type	Contact	Switch Position		Type M = Maintained S = Spring Return	Chrome		Black Max	
		Left	Right		Short Lever	Long Lever	Short Lever	Long Lever
					2-Position Operator			
No Contacts	—	—	—	M M	52SA2AAB	52SB2AAB	52SX2AAB	52SW2AAB
				M<---S	52SA2ACB	52SB2ACB	52SX2ACB	52SW2ACB
1 N.O.	A	O	X	M M	52SA2AABK1	52SB2AABK1	52SX2AABK1	52SW2AABK1
				M<---S	52SA2ACBK1	52SB2ACBK1	52SX2ACBK1	52SW2ACBK1
1 N.O.	A	O	X	M M	52SA2AABA1	52SB2AABA1	52SX2AABA1	52SW2AABA1
1 N.C.	B	X	O	M<---S	52SA2ACBA1	52SB2ACBA1	52SX2ACBA1	52SW2ACBA1

Contact Type	Contact	Switch Position			Type M = Maintained S = Spring Return	Chrome		Black Max	
		Left	Center	Right		Short Lever	Long Lever	Short Lever	Long Lever
						3-Position Operator			
No Contacts	—	—	—	—	M M M	52SA2CAB	52SB2CAB	52SX2CAB	52SW2CAB
					M M M	52SA2BAB	52SB2BAB	52SX2BAB	52SW2BAB
					S--->M M	52SA2BBB	52SB2BBB	52SX2BBB	52SW2BBB
					M M<----S	52SA2BCB	52SB2BCB	52SX2BCB	52SW2BCB
					S--->M<---S	52SA2BDB	52SB2BDB	52SX2BDB	52SW2BDB
1 N.O.	A	O	O	X	M M M	52SA2CABA1	52SB2CABA1	52SX2CABA1	52SW2CABA1
					S--->M M	52SA2CBBA1	52SB2CBBA1	52SX2CBBA1	52SW2CBBA1
1 N.C.	B	X	O	O	M M<----S	52SA2CCBA1	52SB2CCBA1	52SX2CCBA1	52SW2CCBA1
					S--->M<---S	52SA2CDBA1	52SB2CDBA1	52SX2CDBA1	52SW2CDBA1
1 N.O.	A	O	O	X	M M M	52SA2CABA2	52SB2CABA2	52SX2CABA2	52SW2CABA2
1 N.C.	B	X	O	O	S--->M M	52SA2CBBA2	52SB2CBBA2	52SX2CBBA2	52SW2CBBA2
1 N.O.	C	O	O	X	M M<----S	52SA2CCBA2	52SB2CCBA2	52SX2CCBA2	52SW2CCBA2
1 N.C.	D	X	O	O	S--->M<---S	52SA2CDBA2	52SB2CDBA2	52SX2CDBA2	52SW2CDBA2
1 N.O.	A	O	O	X	M M M	52SA2GABJ2K1	52SB2GABJ2K1	52SX2GABJ2K1	52SW2GABJ2K1
1 N.C.	B	X	O	O	M M M	52SA2GABJ2K1	52SB2GABJ2K1	52SX2GABJ2K1	52SW2GABJ2K1
1 N.C.	C	O	X	O	M M M	52SA2GABJ2K1	52SB2GABJ2K1	52SX2GABJ2K1	52SW2GABJ2K1

Contact Type	Contact	Switch Position				Type M = Maintained S = Spring Return	Chrome		Black Max	
		Left	Center	Center	Right		Short Lever	Long Lever	Short Lever	Long Lever
							4-Position Operator			
No Contacts	—	—	—	—	—	M M M M	52SA2HAB	52SB2HAB	52SX2HAB	52SW2HAB
1 N.O.	A	X	O	O	O	M M M M	52SA2HABJ2K1	52SB2HABJ2K1	52SX2HABJ2K1	52SW2HABJ2K1
1 N.C.	B	O	X	O	O	M M M M	52SA2HABJ2K1	52SB2HABJ2K1	52SX2HABJ2K1	52SW2HABJ2K1
1 N.C.	C	O	O	X	O	M M M M	52SA2HABJ2K1	52SB2HABJ2K1	52SX2HABJ2K1	52SW2HABJ2K1
1 N.O.	A	O	O	O	X	M M M M	52SA2HABJ2K2	52SB2HABJ2K2	52SX2HABJ2K2	52SW2HABJ2K2
1 N.O.	B	X	O	O	O	M M M M	52SA2HABJ2K2	52SB2HABJ2K2	52SX2HABJ2K2	52SW2HABJ2K2
1 N.C.	C	O	X	O	O	M M M M	52SA2HABJ2K2	52SB2HABJ2K2	52SX2HABJ2K2	52SW2HABJ2K2
1 N.C.	D	O	O	X	O	M M M M	52SA2HABJ2K2	52SB2HABJ2K2	52SX2HABJ2K2	52SW2HABJ2K2

Note: X = Closed / O = Open

1) Readily available items are in **bold**.

This is a small representation of stocked items.

Push Buttons & Signaling Devices

30mm Water, Oil Tight & Corrosion Resistant – Class 52

Keyed Selector Switch

Selection Guide

Keyed Selector Switch

Part Number	52	S	C						
		a	b	c	d	e	f³	g³	h

a	Code	Type
	S	Selector Switch

b	Code	Finish
	C	Chrome – Command 52

c	Code	Style
	5	Non-Standard Lock/Key ^{1a}
	6	Standard Lock/Key

d	Code	Function
	A	2 Position: CAM A
	B	3 Position: CAM B
	C	3 Position: CAM C ²
	D	3 Position: CAM D
	E	3 Position: CAM E
	G	3 Position: CAM G
	H	4 Position: CAM H

e	Code	Lock Type
		2 Position
		Maintained / Spring Return
		Key Removal
		Left Right
	E	All Maintained X X
	F	All Maintained X —
	G	All Maintained — X
	X	Spring from Right X —

		3 Position				
		Maintained Position	Spring Return	Key Removal		
				Left	Center	Right
	E	All	—	X	X	X
	F	All	—	X	—	—
	G	All	—	—	—	X
	H	All	—	—	X	—
	J	All	—	X	—	X
	K	All	—	X	X	—
	M	All	—	—	X	X
	T	Center, Right	Left	—	X	—
	U	Left, Center	Right	—	X	—
	V	Center	Left, Right	—	X	—
	W	Center, Right	Left	—	—	X
	Y	Center, Right	Left	—	X	X
	Z	Left, Center	Right	X	X	X

		4 Position				
		Maintained Position	Key Removal			
			Left	Left Center	Right Center	Right
	E	All	X	X	X	X
	F	All	X	—	—	—
	G	All	—	—	—	X

f ³	Code	Contact Blocks
	A	1 NO - 1 NC
	J	1 NC
	K	1 NO
	E	1 NC (LB)
	H	1 NO (EM)

g ³	Code	Contact Quantity & Location	
		Left	Right
	0	1	—
	1	—	1
	2	1	1
	3	2	—
	4	—	2
	5	2	1
	6	1	2
	7	2	2
	8	3	—
	9	—	3

h	Code	Key Type ^{1b}
	Blank	501CH
	X298	550CH
	X299	549CH
	X300	548CH
	X301	547CH
	X302	506CH



Standard Lock/Key

1a. To Order 1 to 25 special locks for keyed selector switches simply replace the 6 in the 5th digit of the catalog number with a 5 when entering your order.

(Ordering Example: 52SC6AE is changed to 52SC5AE and all locks - up to 25 will be unique).

Per order, line will be uniquely keyed.

1b. b. To order the specific lock types shown in table h, simply append the corresponding "X" suffix to a standard part number (Ordering Example: 52SC6AEX298).

Note: Same list price applies as standard keyed locks.

2. C CAM on spring return selectors is limited to 4 contact blocks. For CAM selection see page 10/164.

3 For operator without contact blocks leave positions f and g blank.

Push Buttons & Signaling Devices

30mm Water, Oil Tight & Corrosion Resistant – Class 52

Keyed Selector Switch

1
2
3
4
5
6
7
8
9
10

Key-operated Selector Switch, Non-Illuminated¹⁾

Contact Type	Contact	Switch Position		Type	Key Removal	
		Left	Right	M = Maintained S = Spring Return	Left	Both
					2-Position Operator	
No Contacts	—	—	—	M M	52SC6AF	52SC6AE
				M<---S	52SC6AX	—
1 N.O.	A	O	X	M M	52SC6AFK1	52SC6AEK1
				M<---S	52SC6AXK1	—
1 N.O.	A	O	X	M M	52SC6AFA1	52SC6AEA1
1 N.C.	B	X	O	M<---S	52SC6AXA1	—

Contact Type	Contact	Switch Position			Type	Key Removal							
		Left	Center	Right	M = Maintained S = Spring Return	Left	Right	Center	Left & Center	Left & Right	Center & Right	All Positions	
						3-Position Operator							
No Contacts	—	—	—	—	M M M	52SC6CF	52SC6CG	52SC6CH	52SC6CK	52SC6CJ	52SC6CM	52SC6CE	
					M M M	52SC6BF	52SC6BG	52SC6BH	52SC6BK	52SC6BJ	52SC6BM	52SC6BE	
					S--->M	M	—	52SC6BW	52SC6BT	—	—	52SC6BY	—
					M M<----S	—	—	52SC6BU	52SC6BZ	—	—	—	—
					S--->M<---S	—	—	52SC6BV	—	—	—	—	—
1 N.O.	A	O	O	X	M M M	52SC6CFA1	52SC6CGA1	52SC6CHA1	52SC6CKA1	52SC6CJA1	52SC6CMA1	52SC6CEA1	
					S--->M	M	—	52SC6CWA1	52SC6CTA1	—	—	52SC6CYA1	—
					M M<----S	—	—	52SC6CUA1	52SC6CZA1	—	—	—	—
1 N.C.	B	X	O	O	S--->M<---S	—	—	52SC6CVA1	—	—	—	—	
1 N.O.	A	O	O	X	M M M	52SC6CFA2	52SC6CGA2	52SC6CHA2	52SC6CKA2	52SC6CJA2	52SC6CMA2	52SC6CEA2	
1 N.C.	B	X	O	O	S--->M	M	—	52SC6CWA2	52SC6CTA2	—	—	52SC6CYA2	—
1 N.O.	C	O	O	X	M M<----S	—	—	52SC6CUA2	52SC6CZA2	—	—	—	
1 N.C.	D	X	O	O	S--->M<---S	—	—	52SC6CVA2	—	—	—	—	
1 N.O.	A	O	O	X	M M M	52SC6GFJ2K1	52SC6GGJ2K1	52SC6GHJ2K1	52SC6GKJ2K1	52SC6GJ2K1	52SC6GMJ2K1	52SC6GEJ2K1	
1 N.C.	B	X	O	O									
1 N.C.	C	O	X	O									

Contact Type	Contact	Switch Position				Type	Key Removal	
		Left	Left Center	Right Center	Right	M = Maintained S = Spring Return	Right	All Positions
							4-Position Operator	
No Contacts	—	—	—	—	—	M M M M	52SC6HG	52SC6HE
1 N.O.	A	X	O	O	O			
1 N.C.	B	O	X	O	O	M M M M	52SC6HGJ2K1	52SC6HEJ2K1
1 N.C.	C	O	O	X	O			
1 N.O.	A	O	O	O	X			
1 N.O.	B	X	O	O	O	M M M M	52SC6HGJ2K2	52SC6HEJ2K2
1 N.C.	C	O	X	O	O			
1 N.C.	D	O	O	X	O			

Note: X = Closed / O = Open

1) Readily available items are in bold.

All Operators listed above are furnished with Lock No. 501CH

This is a small representation of stocked items.

Push Buttons & Signaling Devices

30mm Water, Oil Tight & Corrosion Resistant – Class 52

Selector Push Button

Selection Guide

Selector Push Button

Part Number	52	S	A	c	d	e	f ¹
		a	b				

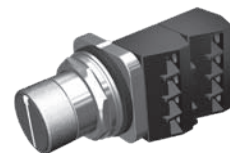

Selector Push Buttons

Finish	Style	Function	Color	Contacts	Part Number
Chrome	Flush Selector Push Button	2 Position CAM Q	Black	None	52SA3Q1
Chrome	Flush Selector Push Button	2 Position CAM R	Black	None	52SA3R1
Chrome	Flush Selector Push Button	2 Position CAM P	Black	None	52SA3P1

Readily available items are in **bold**.
This is a small representation of stocked items.

a	Code	Type
	S	Selector Push Buttons

b	Code	Finish
	A	Chrome - Command 52

c	Code	Style
	3	Flush Button
	4	Extended Button - 1/2"

d	Code	Function
	P	2 Position: CAM P
	Q	2 Position: CAM Q
	R	2 Position: CAM R
S	3 Position: CAM S	

e	Code	Color
	1	Black
	2	Red

f ¹	Contact Blocks									
	CAM P (2 Selector Position)									
	Left		Center		Right		Contact Blocks	Mounting Position		
	N	D	N/A	N/A	N	D				
J0	X	O	—	—	O	O	NC	Left		
K0	O	X	—	—	X	X	NO	Left		
	CAM Q (2 Selector Position)									
	Left		Center		Right		Contact Blocks	Mounting Position		
	N	D	N/A	N/A	N	D				
J0	X	X	—	—	O	O	NC	Left		
J1	X	O	—	—	O	O	NC	Right		
K0	O	O	—	—	O	X	NO	Left		
K1	O	X	—	—	O	X	NO	Right		
	CAM R (2 Selector Position)									
	Left		Center		Right		Contact Blocks	Mounting Position		
	N	D	N/A	N/A	N	D				
J0	X	X	—	—	X	O	NC	Left		
J1	X	O	—	—	X	X	NC	Left		
K0	O	O	—	—	O	X	NO	Right		
K1	O	X	—	—	O	O	NO	Right		
	CAM S (3 Selector Position)									
	Left		Center		Right		Contact Blocks	Mounting Position		
	N	D	N	D	N	D				
J0	X	O	O	O	O	O	NC	Left		
J1	X	O	X	X	O	O	NC	Right		
K0	O	O	O	X	O	X	NO	Left		
K1	O	X	O	O	O	X	NO	Right		

Note: X = Closed / O = Open

1 For operator without contact blocks leave position f blank

Pushbutton Units and Indicator Lights

30mm Water, Oil Tight & Corrosion Resistant – Class 52

Special devices

1

2

3

4

5

6





7

8

9

10

Selection and ordering data

	Version	Ohms / color	Order no.	Pack			
	Potentiometer operator 2 Watts, 500 V AC/DC (Type 12/3 only)	50 150 250 500 750 1 K 2.5 K 5 K 10 K 15 K 25 K 50 K 100 K 150 K 250 K 500 K 1 M 1.5 M 2 M 5 M	52MA3B01 52MA3B03 52MA3B04 52MA3B06 52MA3B07 52MA3B08 52MA3B10 52MA3B12 52MA3B14 52MA3B15 52MA3B16 52MA3B18 52MA3B20 52MA3B21 52MA3B22 52MA3B24 52MA3B26 52MA3B27 52MA3B28 52MA3B31	1			
		2 Button maintained operator	black (flush) / red (flush) black (flush) / red (extended) black (flush) / yellow (mushroom) green (flush) / red (flush) green (flush) / red (extended) green (flush) / red (mushroom) green (flush) / green (mushroom)	52MA2A1A2 52MA2A1B2 52MA2A1D4 52MA2A3A2 52MA2A3B2 52MA2A3D2 52MA2A3D3	1		
		Button remains depressed when pushed	less caps	52MA2			
			Wobble stick 2.5" operator For use with 52BAJ (NC) contact block	red green grey	52ABW2 ^① 52ABW3 ^① 52ABW6 ^①	1	
				Maintained toggle operator		52ABT	1

① For use with 52BAJ (NC) contact block

Pushbutton Units and Indicator Lights

30mm Water, Oil Tight & Corrosion Resistant – Class 52

Cam selection

Selection and ordering data

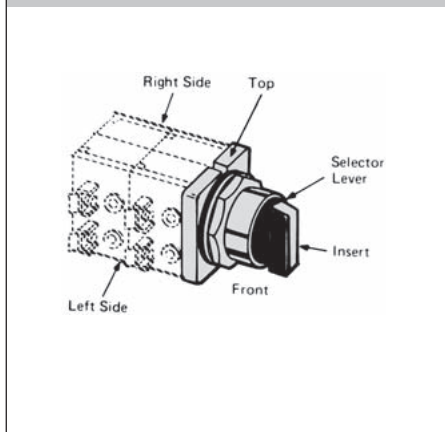

Ordering Information

- Contact blocks are ordered separately, [see page 10/164](#)
- Determine which table to use based upon the type of selector (non-illum selector switch-top, illum selector switch-middle, and selector pushbutton-bottom).
- Find the correct number of selector positions (2, 3 or 4 positions).
- Select the contact operation required for each selector position. X indicates the contacts are closed, while O indicates the contacts are open. (For the selector pushbutton, N=normal and D=depressed).
- Contact block must be assembled in position shown for each circuit application.
- Identify the CAM letter required for the chosen contact operation (only 1 CAM can be used per selector switch or selector pushbutton).
- Contact blocks must be assembled in the position shown for each circuit application. The mounting position is viewed from the front of the device.

Ordering CAMs D, E or G

- CAM D, E or G may be ordered at the same price by changing the 6th character of the selector catalog number. Example: Selector with D cam **52SX2DAB**.

Size Requirements

- C CAM on spring return selectors is limited to 4 contact blocks.
- Selector operators in enclosures are limited to depth of 1 contact block. (2 blocks wide).

Non-illuminated and keyed selector switches (viewed from front)

2 Selector Positions				Contact Blocks	CAM	Mounting		
Left		Right	Left			Right		
X		O		NC (52BAJ)	A	L	or R	
O		X		NO (52BAK)	A	L	or R	
3 Selector Positions				Contact Blocks	CAM	Mounting		
Left	Center	Right	Left			Right		
X		O		NO (52BAK)	B		R	
O		X		NO (52BAK)	B	L		
X	X	O		NC (52BAJ)	B	L		
O	X	X		NC (52BAJ)	B		R	
X	O	X		2NO (2-52BAK)	B	L	and R	
X	O	O		NC (52BAJ)	C	L	or R	
O	O	X		NO (52BAK)	C	L	or R	
O	X	O		NC (52BAJ)	D	L	or R	
O	O	X		NO (52BAK)	D	L	or R	
X	O	O		NO (52BAK)	E	L	or R	
O	X	O		NC (52BAJ)	E	L	or R	
X	O	O		NC (52BAJ)	G	L		
O	X	O		NC (52BAJ)	G		R	
O	O	X		NO (52BAK)	G	L	or R	
4 Selector Positions					Contact Blocks	CAM	Mounting	
Left	Left Center	Right Center	Right	Left			Right	
X	O	O	O	NO (52BAK)	H		R	
O	X	O	O	NC (52BAJ)	H	L		
O	O	X	O	NC (52BAJ)	H		R	
O	O	O	X	NO (52BAK)	H	L		

Illuminated selector switches (viewed from front)

2 Selector Positions				Contact Blocks	CAM	Mounting	
Left		Right	Left			Right	
X		O		NC (52BAJ)	A	L	
O		X		NO (52BAK)	A	L	
3 Selector Positions				Contact Blocks	CAM	Mounting	
Left	Center	Right	Left			Right	
O	O	X		NC (52BAJ)	B		R
O	X	O		NO (52BAK)	B		R
X	O	O		NC (52BAJ)	C	L	
O	O	X		NO (52BAK)	C	L	

Selector Pushbuttons (viewed from front)

2 Selector Positions						Contact Blocks	CAM	Mounting	
Left		Right		Left	Right				
N	D	N	D						
X	O	O	O	NC (52BAJ)	Q				R
X	X	O	O	NC (52BAJ)	Q	L			
O	X	O	X	NO (52BAK)	Q				R
O	O	O	X	NO (52BAK)	Q	L			
X	O	O	O	NC (52BAJ)	P	L	or		R
O	X	X	X	NO (52BAK)	P	L	or		R
X	X	X	O	NC (52BAJ)	R	L			
X	O	X	X	NC (52BAJ)	R				R
O	X	O	O	NO (52BAK)	R				R
O	O	O	X	NO (52BAK)	R	L			
3 Selector Positions						Contact Blocks	CAM	Mounting	
Left		Center	Right						
N	D	N	D	N	D				
X	O	O	O	O	O	NC (52BAJ)	S	L	
X	O	X	X	O	O	NC (52BAJ)	S		R
O	X	O	O	O	X	NO (52BAK)	S		R
O	O	O	X	O	X	NO (52BAK)	S	L	

Pushbutton Units and Indicator Lights

30mm Water, Oil Tight & Corrosion Resistant – Class 52

Custom selector switch designs

1
2
3
4
5
6
7
8
9
10

Selection and ordering data

Assembled Non-illuminated Selector Switches

- Determine contact block and location from above.
- Select block suffix. Ex: **J = 52BAJ**.
- Now select position suffix.
- **1-52BAJ** block mounted on right side, suffix will be **J 1**.
- Additional suffixes allow for multiple quantities and locations.
- Repeat process for next block if required.
- Add list price of blocks to operator list price.
- Consult factory for delivery.

Example 1: X O O
 O O X
HAND-OFF-AUTO Maintained Switch
Catalog No **52SA2CAB A 1 = 52A2CABA1**
(**52BJK** block mounted on right side)

Example 2: X O O **52BAJ (L)**
 O X O **52BAJ (R)**
 O O X **52BAK (L or R))K1**
G Cam required
Catalog No **52SA2GAB J2 K1 = 52SA2GABJ2K1**







Block Suffix	Position Suffix	
	Suffix	Quantity and Location
		Left Right
A = 1 NO - 1 NC, 52BJK	0	1 —
E = NC Late Break, 52BAE	1	— 1
H = NO Early Make, 52BAH	2	1 1
J = NC, 52BAJ	3	2 —
K = NO, 52BAK	4	— 2
	5	2 1
	6	1 2
	7	2 2
	8	3 —
	9	— 3

Pushbutton Units and Indicator Lights

30mm Water, Oil Tight & Corrosion Resistant – Class 52

Accessories and spare parts

Selection and ordering data

Version	Suitable for	Color	Order no.
	Flush actuator lens cap	black	52RA1A1
		red	52RA1A2
	Extended actuator lens cap	green	52RA1A3
		yellow	52RA1A4
		blue	52RA1A5
		gray	52RA1A6
		orange	52RA1A8
		kit- all colors	52RA1AN
		black	52RA1B1
		red	52RA1B2
		green	52RA1B3
		yellow	52RA1B4
blue	52RA1B5		
gray	52RA1B6		
orange	52RA1B8		
1 of each color cap	52RA1BN		
	Mushroom head cap - Plastic	black	52RB3E1
		red	52RB3E2
		green	52RB3E3
		yellow	52RB3E4
		blue	52RB3E5
		gray	52RB3E6
		orange	52RB3E8
		1 kit of each color cap	52RB3EN
		black	52RB3D1
		red	52RB3D2
		green	52RB3D3
		yellow	52RB3D4
		blue	52RB3D5
		gray	52RB3D6
orange	52RB3D8		
1 of each color cap	52RB3DN		
	Mushroom head cap - Metal	chrome	52RB3FC
		red	52RB3F2
		green	52RB3F3
	Replacement Lens for Indicator Lights	red	52RA4S2
		green	52RA4S3
		blue	52RA4S5
		amber	52RA4S9
		clear	52RA4SA
		white	52RA4SB
		1 of each color	52RA4SN
		red	52RA4T2
		green	52RA4T3
		blue	52RA4T5
		amber	52RA4T9
		clear	52RA4TA
		white	52RA4TB
		1 of each color	52RA4TN
	Replacement Lens for Push to Test/Illuminated Pushbuttons	red	52RA5S2
		green	52RA5S3
		blue	52RA5S5
		amber	52RA5S9
		clear	52RA5SA
		white	52RA5SB







Pushbutton Units and Indicator Lights

30mm Water, Oil Tight & Corrosion Resistant – Class 52

Accessories and spare parts

1
2
3
4
5
6
7
8
9
10

Selection and ordering data

Version	Suitable for	Color	Order no.
Mushroom head push pull illuminated plastic	For small 1 3/4" type, push-pull units	red green amber	52RC3JR 52RC3JS 52RC3JT
	For large 2 1/2" type, push-pull units	red green amber	52RC3KR 52RC3KS 52RC3KT
 Mushroom head push pull illuminated metal	Chrome, for small 1 3/4" type, push-pull units	red green amber white	52RB3H2 52RB3H3 52RB3H9 52RB3HB
	BlackMax, for small 1 3/4" type, push-pull units	red green amber white	52RX3H2 52RX3H3 52RX3H9 52RX3HB
 Mushroom head push pull non-illuminated plastic	For small 1 3/4" type, push-pull units (catalog numbers starting with 52PP or 52BP) ^①	black red green yellow blue gray orange 1 of each color	52RC3D1 52RC3D2 52RC3D3 52RC3D4 52RC3D5 52RC3D6 52RC3D8 52RC3DN
	For large 2 1/2" type, push-pull units (catalog numbers starting with 52PP or 52BP) ^①	black red green yellow blue gray orange 1 of each color	52RC3E1 52RC3E2 52RC3E3 52RC3E4 52RC3E5 52RC3E6 52RC3E8 52RC3EN
Mushroom head push pull non-illuminated metal	For small 1 3/4" type, push-pull units (catalog numbers starting with 52PP or 52BP) ^①	red green chrome	52RC3F2 52RC3F3 52RC3FC
 Twist to release head illuminated plastic	For small twist to release units	red green amber	52RC3RR 52RC3RS 52RC3RT
 Twist to release head non-illuminated plastic	For small twist to release units	red green yellow	52RC3R2 52RC3R3 52RC3R4
 Replacement lens kit for illuminated selector switches (Knob with Insert)		red green blue amber clear white	52RA6P2 52RA6P3 52RA6P5 52RA6P9 52RA6PA 52RA6PB
 Lever inserts	Short lever	red green yellow blue gray orange white	52RA2A2 52RA2A3 52RA2A4 52RA2A5 52RA2A6 52RA2A8 52RA2AB
	Long lever	red green yellow blue gray orange white	52RA2B2 52RA2B3 52RA2B4 52RA2B5 52RA2B6 52RA2B8 52RA2BB









^① For push-pull units whose catalog numbers that start with 52PX, 52PA or 52PE, replacement heads are available. Order from the 52RB type "Mushroom head pushbutton cap" section on page 10/164.

Pushbutton Units and Indicator Lights

30mm Water, Oil Tight & Corrosion Resistant – Class 52

Accessories and spare parts

Selection and ordering data

Version	Suitable for	Color	Order no.
 Protective boot Offers protection from ice and foreign substances from interfering with button operation	Flush pushbutton operations	clear black	52AABA 52AAB1
 Guards Prevents accidental operation	Non-illuminated basic pushbuttons 1 5/8" mushroom pushbuttons, 1 3/4" push-pull units ^① , and twist to release units Push to test/illuminated pushbutton and indicator lights	chrome blackmax chrome blackmax chrome blackmax	52AAGP 52AXGP 52AAGM 52AXGM 52AAGL 52AXGL
 EMERGENCY-STOP Lock Out	Class 52 Illuminated Mushroom Head Pushbuttons; 304 Stainless Steel	chrome (304 SS)	52AALE
 EMERGENCY-STOP Backing Ring	Yellow 90mm E-STOP Backing Ring		52AAR
 Locknuts Replacement front ring	Non-illuminated basic pushbuttons Non-illuminated mushroom pushbuttons Push-pull and twist-to-release units (only for push-pull units starting with 52PP or 52BP) ^② Indicator Lights Selector switches	chrome blackmax chrome blackmax chrome blackmax blue amber chrome blackmax	52AANP 52AXNP 52AANL 52AXNL 52CANP 52CXNP 52AANL 52AXNL 52AANS 52AXNS
Mounting Accessories	Class 52 Trim Washer Kit (Set of 10 pcs) Class 52 Washer Kit (Include 2-Neoprene Gaskets, 1-Trim Washer, 1-Index Locking Ring (chrome))	chrome	52AAQ 52AAD
Padlock attachments	Non-illuminated basic pushbuttons	flush extended	52AALA 52AALB
 Padlock cover Lock devices in off position	Pushbuttons, selector switches, and non-illuminated mushroom heads		52AALS
 Lock nut wrench	All devices		52MAWB
 Hole plugs		corrosion resistant steel, grey stainless steel	52AAH6 52ABH6 52ABHS
Spare keys (Kit includes 1 Key)	Class 52 Standard Keyed Selector Switch. Keyed Selector Switch ordered with Suffix X302. Keyed Selector Switch ordered with Suffix X301. Keyed Selector Switch ordered with Suffix X300. Keyed Selector Switch ordered with Suffix X299. Keyed Selector Switch ordered with Suffix X298.	501CH 506CH 547CH 548CH 549CH 550CH	52KEY-501CH 52KEY-506CH 52KEY-547CH 52KEY-548CH 52KEY-549CH 52KEY-550CH
Grounding kit	All devices		52AL109145
 Touchsafe contact blocks with gold flashing 52 BAJ 52 BAK 52 BAR	1 NO 1 NC 1 NO - 1 NC 1 NO early make 1 NC late break 1 NO - 1 NC 1 NC extra late break closes before 52BAK opens after 52BAJ Reed switch; UL listed for class 1 division 2; .25A Max, 200V AC, 10 Watt max .5A Max, 200V DC, 10 Watt max		52BAK 52BAJ ^④ 52BJK ^④ 52BAH 52BAE 52BAR ^④ 52BAU

① These can also be used with the 1 5/8" push-pull devices.

② For push-pull units starting with part numbers 52PA, 52PE or 52PX, replacement locknuts can be ordered using 52AANL (Chrome) and 52AXNL (BlackMax).

③ Hermetically Sealed

④  Positive opening according to IEC 60947-5-1, Appendix K.

Pushbutton Units and Indicator Lights

30mm Water, Oil Tight & Corrosion Resistant – Class 52

Accessories and spare parts

1
2
3
4
5
6
7
8
9
10

Selection and ordering data

Version	Suitable for	Lamp voltage	Color	Order no.
Lamps with screw connection, miniature bayonet (BA 9s style)				
Incandescent lamps,				
	Flashing, type 267 lamp (replaces 755 lamp)	51, 52	6 V	52AABNF
	6V type 755 lamp (Rated 150 mA)	51, 52	6 V	52AABN
	12V type 756 (Rated 80 mA)	51, 52	12 V	52AACN
	24V type 757 (Rated 80 mA)	51, 52	24 V	52AADN
	48V, 2W	52	48 V	3SB1902-1AP
	60V, 2W	52	60 V	3SR9424
	120V, 2.5W, type #120MB (Rated 250 mA)	52	120 V	52AAENC1
Neon (uses resistors) type B2A (NE-51H)	52	120 V	52AAPN	
Candelabra, 120V, 3W, Full voltage type 3S6/5	52 older revision styles	120 V		52AAENC
LED bulbs^①				
LED, BA9s type ^②	Class 52	6 V AC/DC 24 V AC/DC 120 V AC/DC		52AEB□ 52AED□ 52AEE□
Super-Bright LED ^②	Class 52	6 V AC/DC 24 V AC/DC 120 V AC/DC 120 V DC		52AEB□7 52AED□7 52AEE□7 52AEV□7
LED lighting module with integrated LED.				
Single LED (Rated 35 mA Maximum)	Class 52	24 V AC/DC 120 V AC 240 V AC		52AAIL□ 52AAIM□ 52AAIN□
Full voltage lighting module accessory with BA9s type lamp^①				
LED ^②	Class 52	6 V AC/DC 24 V AC/DC 120 V AC/DC		52AAF□B 52AAF□D 52AAF□E
Super-Bright LED ^②	Class 52	6 V AC/DC 24 V AC/DC 120 V AC/DC		52AAF□Y 52AAF□D□Y 52AAF□E□Y
Incandescent bulb	Class 52	6 V AC/DC 24 V AC/DC 120 V AC/DC		52AAF□B 52AAF□D 52AAF□E
Transformer lighting module accessory with BA9s type lamp^①				
LED	Class 52	120 V AC 240 V AC 480 V AC 600 V AC		52AAT□G□B 52AAT□H□B 52AAT□J□B 52AAT□K□B
Super-Bright LED	Class 52	120 V AC 240 V AC 480 V AC 600 V AC		52AAT□G□Y 52AAT□H□Y 52AAT□J□Y 52AAT□K□Y
Incandescent bulb	Class 52	120 V AC 240 V AC 480 V AC 600 V AC		52AAT□G 52AAT□H 52AAT□J 52AAT□K

Color options:

red
green
yellow/amber
blue
white/clear

2
3
4
5
B

① Standard LED lamps are recommended for indoor applications, Super-Bright LED Lamps are recommended for outdoor applications.

② 6V, 24V (Super Bright only) and 120V are currently AC only. Replaced by AC/DC rated versions end of 2014.

Pushbutton Units and Indicator Lights

30mm Water, Oil Tight & Corrosion Resistant – Class 52

Dimensional drawings

Non-Illuminated Push-Pull
Metal Mushroom Head

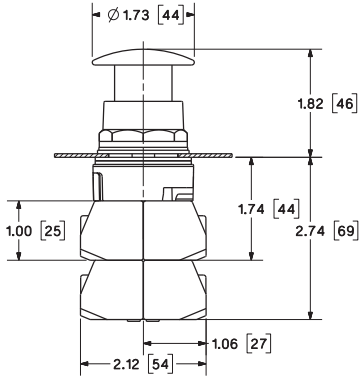

Non-Illuminated Push-Pull
Small Plastic Mushroom Head

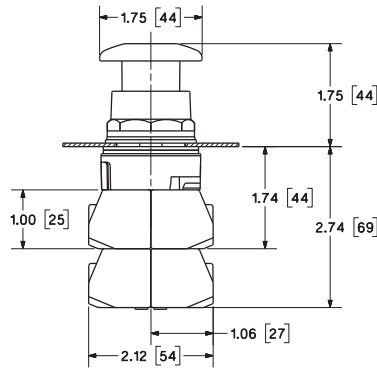

Non-Illuminated Push-Pull
Large Plastic Mushroom Head

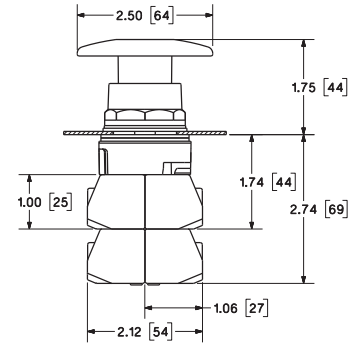

Illuminated Push-Pull
Metal Mushroom Head

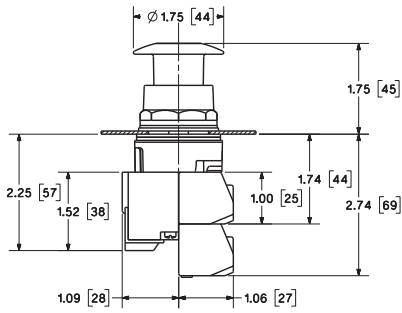

Fully Illuminated Push-Pull
Small Plastic Mushroom Head

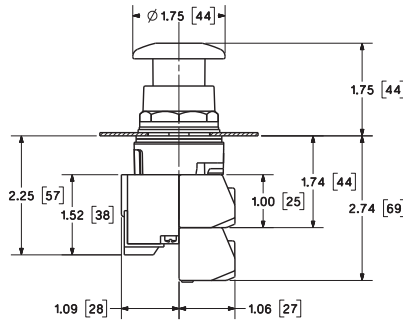

Illuminated Push-Pull
Large Plastic Mushroom Head

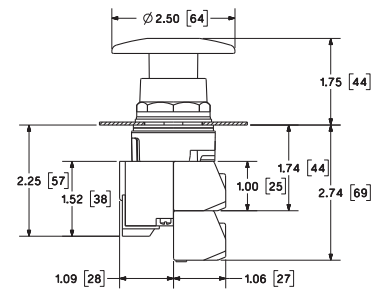

Non-Illuminated Twist Release
Plastic Mushroom Head

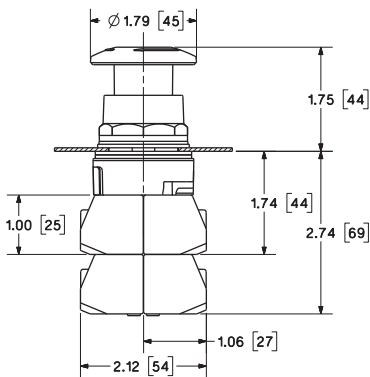

Illuminated Twist Release
Plastic Mushroom Head

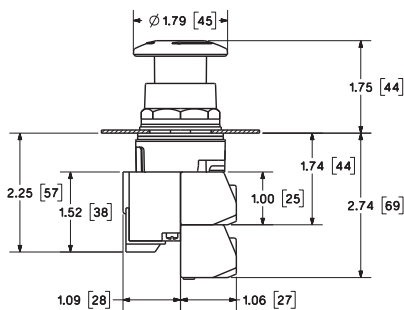

Illuminated Pushbutton Flush Lens
Illuminated Pushbutton Extended Lens
Illuminated Push to Test

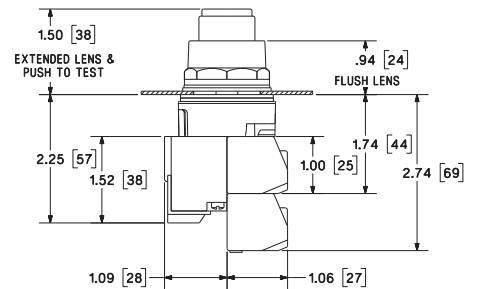

Pushbutton Units and Indicator Lights

30mm Water, Oil Tight & Corrosion Resistant – Class 52

Dimensional drawings

1

2

3

4

5

6

7

8

9

10

Selector Switch
Non-Illuminated

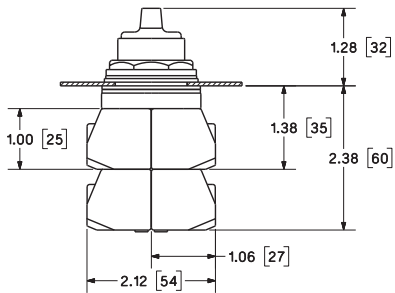

Selector Switch
Illuminated

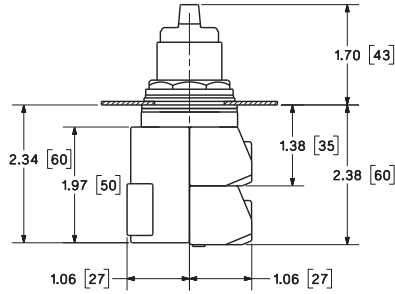

Indicator Light
Plastic Lens

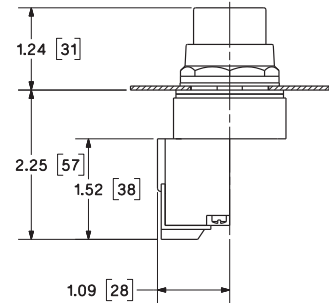

Momentary Pushbutton
Non-Illuminated Flush Cap

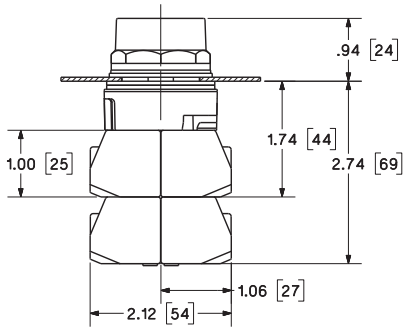

Momentary Pushbutton
Non-Illuminated Raised Cap

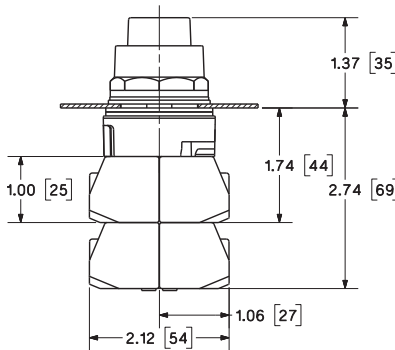

Indicator Light
Glass Lens

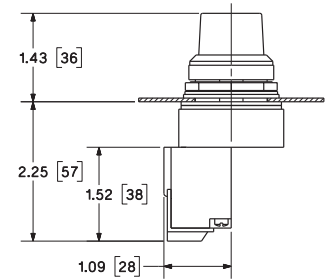

Momentary Pushbutton
Metal Mushroom Head

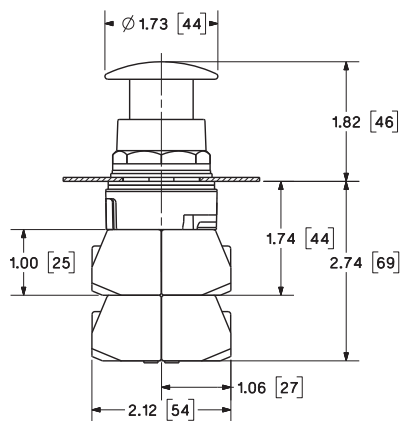

Momentary Pushbutton
Small Plastic Mushroom Head

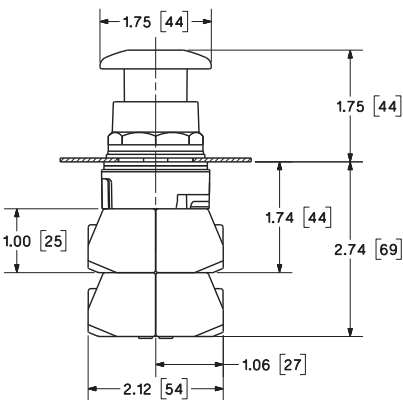

Momentary Pushbutton
Large Plastic Mushroom Head

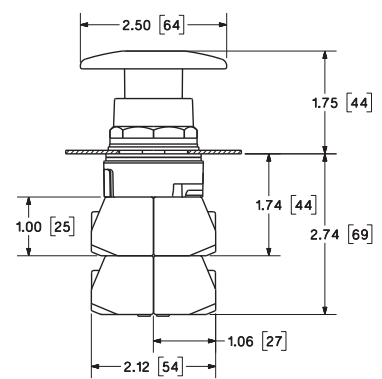

Pushbutton Units and Indicator Lights

30mm Water, Oil Tight & Corrosion Resistant – Class 52

Dimensional drawings

Illuminated Momentary Pushbutton
Metal Mushroom Head

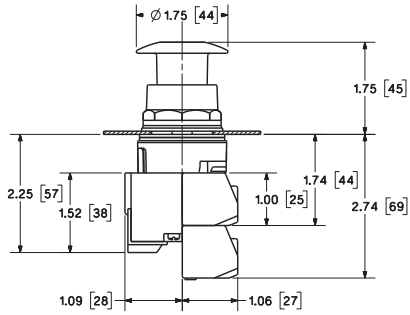

Illuminated Momentary Pushbutton
Small Plastic Mushroom Head

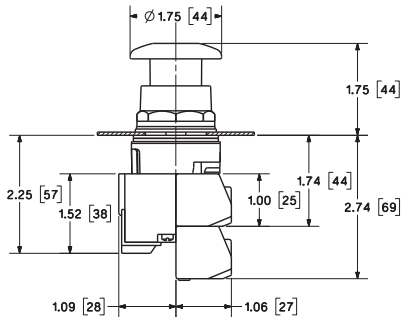

Illuminated Momentary Pushbutton
Large Plastic Mushroom Head

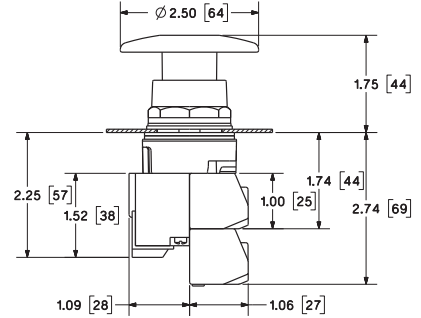

Selector Switch
Keyed

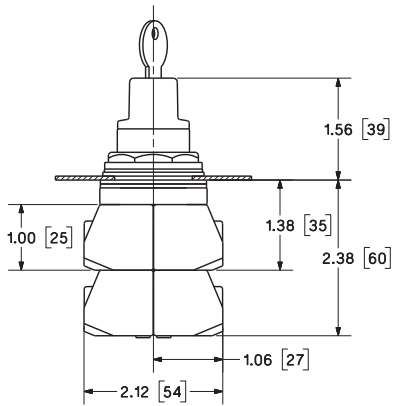

Wobble Switch

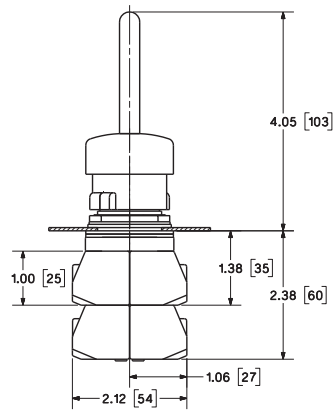

Potentiometer Switch

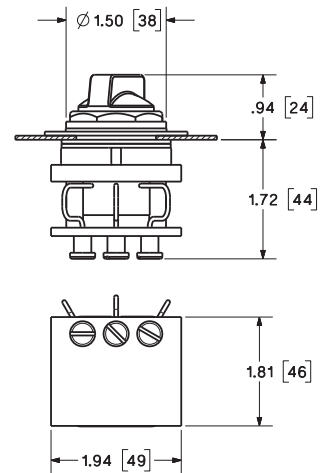

Toggle Switch

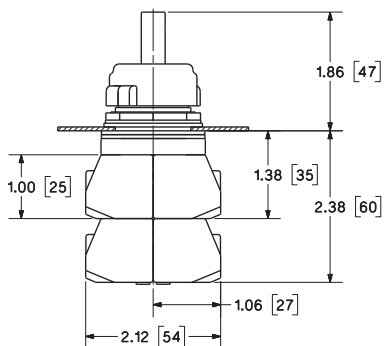

Selector Pushbutton Switch
Flush Cap

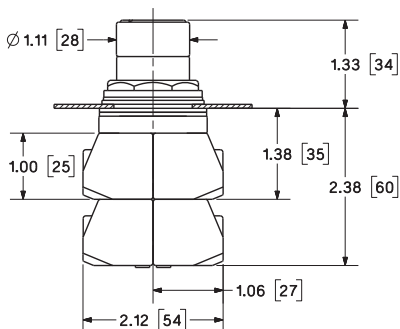

Selector Pushbutton Switch
Raised Cap

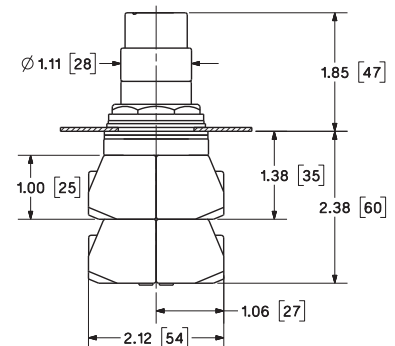

Pushbutton Units and Indicator Lights

30mm Water, Oil Tight & Corrosion Resistant – Class 52

Dimensional drawings

1

2

3

4

5

6

7

8

9

10

Momentary Pushbutton Guard
Illuminated Push to Test Guard

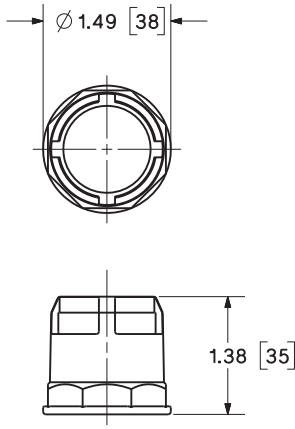

Mushroom Head Guard

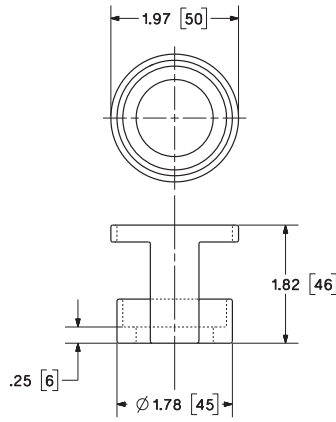

Contact Block

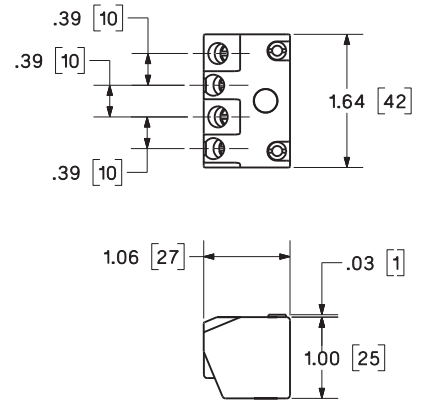

Large Metal Legend Plate

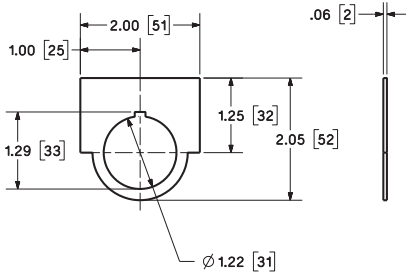

Automotive Metal Legend Plate

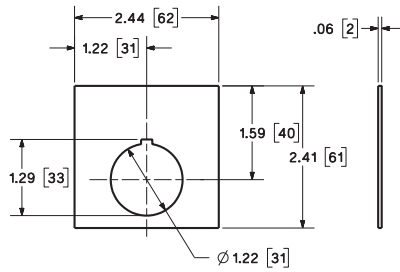

Large Plastic Legend Plate

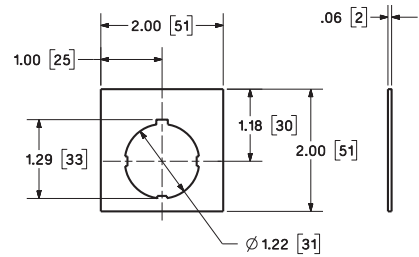

Pushbutton Units and Indicator Lights

30mm Water, Oil Tight & Corrosion Resistant - Class 52

Class 52 oiltight pushbutton stations

Selection and ordering data

	Actuator identification C = top device in station B = middle device in station A = bottom device in station	Degree of protection ^①	Contact / voltage	No. of command points	Order no.	Pack Unit
1 unit control station	A = Momentary flush pushbutton black, label "START"	NEMA 12	1NO - 1NC	1	52C101A	
	A = Momentary raised pushbutton red, label "STOP"	NEMA 12	1NO - 1NC	1	52C103A	
	A = Momentary mushroom head red, label "STOP"	NEMA 12	1NO - 1NC	1	52C104A	
	A = Maintained metal mushroom head red, label "EMERGENCY STOP"	NEMA 12	1NO - 1NC	1	52C117A	
	A = 2 position selector switch "OFF-ON"	NEMA 12	1NO - 1NC	1	52C159A	
	A = 3 position selector switch "HAND-OFF-AUTO"	NEMA 12	1NO - 1NC	1	52C156A	
	A = Indicator light, red	NEMA 12	120V Transformer type	1	52C131A	
	A = Indicator light, green	NEMA 12	120V Transformer type	1	52C135A	
	A = Momentary flush pushbutton black, label "START"	NEMA 4X Stainless Steel	1NO - 1NC	1	52C101S	
	A = Momentary raised pushbutton red, label "STOP"	NEMA 4X Stainless Steel	1NO - 1NC	1	52C103S	
	A = Momentary mushroom head red, label "STOP"	NEMA 4X Stainless Steel	1NO - 1NC	1	52C104S	
	A = Maintained metal mushroom head red, label "EMERGENCY STOP"	NEMA 4X Stainless Steel	1NO - 1NC	1	52C116S	
	A = 2 position selector switch "OFF-ON"	NEMA 4X Stainless Steel	1NO - 1NC	1	52C159S	
	A = 3 position selector switch "HAND-OFF-AUTO"	NEMA 4X Stainless Steel	1NO - 1NC	1	52C156S	
	A = Momentary flush pushbutton black, label "START"	NEMA 4X Fiberglass	1NO - 1NC	1	52C101X	
	A = Momentary raised pushbutton red, label "STOP"	NEMA 4X Fiberglass	1NO - 1NC	1	52C103X	
	A = Momentary mushroom head red, label "STOP"	NEMA 4X Fiberglass	1NO - 1NC	1	52C104X	
	A = Maintained metal mushroom head red, label "EMERGENCY STOP"	NEMA 4X Fiberglass	1NO - 1NC	1	52C116X	
	A = 2 position selector switch "OFF-ON"	NEMA 4X Fiberglass	1NO - 1NC	1	52C159X	
	A = 3 position selector switch "HAND-OFF-AUTO"	NEMA 4X Fiberglass	1NO - 1NC	1	52C156X	
2 unit control station	B = Momentary flush pushbutton black, label "START" A = Momentary raised pushbutton red, label "STOP"	NEMA 12	1NO, 1NC 1NO, 1NC	2	52C201A	
	B = Momentary flush pushbutton black, label "START" A = Momentary Mushroom head pushbutton red, label "STOP"	NEMA 12	1NO, 1NC 1NO, 1NC	2	52C202A	
	B = Momentary flush pushbutton, label "FORWARD" A = Momentary flush pushbutton, label "REVERSE"	NEMA 12	1NO, 1NC 1NO, 1NC	2	52C204A	
	B = Momentary flush pushbutton, label "UP" A = Momentary flush pushbutton, label "DOWN"	NEMA 12	1NO, 1NC 1NO, 1NC	2	52C223A	
	B = Indicator light, red, label "RUN" A = Maintained selector switch, label "HAND-OFF-AUTO"	NEMA 12	120V Transformer type	2	52C224A	
	B = Indicator light, red A = Indicator light, green	NEMA 12	120V Transformer type	2	52C230A	
	B = Momentary flush pushbutton black, label "START" A = Momentary raised pushbutton red, label "STOP"	NEMA 4X Stainless Steel	1NO, 1NC 1NO, 1NC	2	52C201S	
	B = Momentary flush pushbutton black, label "START" A = Momentary Mushroom head pushbutton red, label "STOP"	NEMA 4X Stainless Steel	1NO, 1NC 1NO, 1NC	2	52C202S	
	B = Momentary flush pushbutton, label "UP" A = Momentary flush pushbutton, label "DOWN"	NEMA 4X Stainless Steel	1NO, 1NC 1NO, 1NC	2	52C223S	
	B = Indicator light, red, label "RUN" A = Maintained selector switch, label "HAND-OFF-AUTO"	NEMA 4X Stainless Steel	120V Transformer type 1NO, 1NC	2	52C224S	
	B = Momentary flush pushbutton black, label "START" A = Momentary raised pushbutton red, label "STOP"	NEMA 4X Fiberglass	1NO, 1NC 1NO, 1NC	2	52C201X	
	B = Momentary flush pushbutton black, label "START" A = Momentary Mushroom head pushbutton red, label "STOP"	NEMA 4X Fiberglass	1NO, 1NC 1NO, 1NC	2	52C202X	
	B = Momentary flush pushbutton, label "UP" A = Momentary flush pushbutton, label "DOWN"	NEMA 4X Fiberglass	1NO, 1NC 1NO, 1NC	2	52C223X	
	B = Indicator light, red, label "RUN" A = Maintained selector switch, label "HAND-OFF-AUTO"	NEMA 4X Fiberglass	120V Transformer type 1NO, 1NC	2	52C224X	

① NEMA 4X Stainless Steel Enclosure is 304 SS.

Pushbutton Units and Indicator Lights

30mm Water, Oil Tight & Corrosion Resistant - Class 52

Class 52 oiltight pushbutton stations

Selection and ordering data

Actuator identification	Degree of protection ^①	Contact / voltage	No. of command points	Order no.	Pack
3 unit control station 	C = Indicator light, red	NEMA 12	120V 1NO, 1NC	3	52C307A
	B = Momentary flush pushbutton black, label "START" A = Momentary raised pushbutton red, label "STOP"		1NO, 1NC 1NO, 1NC		
	C = Momentary flush pushbutton black, label "FORWARD" B = Momentary flush pushbutton black, label "REVERSE" A = Momentary raised pushbutton red, label "STOP"	NEMA 12	1NO, 1NC 1NO, 1NC 1NO, 1NC	3	52C301A
C = Momentary flush pushbutton black, label "UP" B = Momentary flush pushbutton black, label "DOWN" A = Momentary raised pushbutton red, label "STOP"	NEMA 12	1NO, 1NC 1NO, 1NC 1NO, 1NC	3	52C332A	
C = Momentary flush pushbutton black, label "OPEN" B = Momentary flush pushbutton black, label "CLOSE" A = Momentary raised pushbutton red, label "STOP"	NEMA 12	1NO, 1NC 1NO, 1NC 1NO, 1NC	3	52C333A	
C = Momentary flush pushbutton black, label "HI" B = Momentary flush pushbutton, black label "LOW" A = Momentary raised pushbutton red, label "STOP"	NEMA 12	1NO, 1NC 1NO, 1NC 1NO, 1NC	3	52C334A	
C = Indicator light, red	NEMA 4X Stainless Steel	120V 1NO, 1NC 1NO, 1NC	3	52C307S	
B = Momentary flush pushbutton black, label "START" A = Momentary raised pushbutton red, label "STOP"					
C = Momentary flush pushbutton black, label "FORWARD" B = Momentary flush pushbutton black, label "REVERSE" A = Momentary raised pushbutton red, label "STOP"	NEMA 4X Stainless Steel	1NO, 1NC 1NO, 1NC 1NO, 1NC	3	52C301S	
C = Momentary flush pushbutton black, label "UP" B = Momentary flush pushbutton black, label "DOWN" A = Momentary raised pushbutton red, label "STOP"	NEMA 4X Stainless Steel	1NO, 1NC 1NO, 1NC 1NO, 1NC	3	52C332S	
C = Momentary flush pushbutton black, label "OPEN" B = Momentary flush pushbutton black, label "CLOSE" A = Momentary raised pushbutton red, label "STOP"	NEMA 4X Stainless Steel	1NO, 1NC 1NO, 1NC 1NO, 1NC	3	52C333S	
C = Momentary flush pushbutton black, label "HI" B = Momentary flush pushbutton, black label "LOW" A = Momentary raised pushbutton red, label "STOP"	NEMA 4X Stainless Steel	1NO, 1NC 1NO, 1NC 1NO, 1NC	3	52C334S	
C = Indicator light, red	NEMA 4X Fiberglass	120V 1NO, 1NC 1NO, 1NC	3	52C307X	
B = Momentary flush pushbutton black, label "START" A = Momentary raised pushbutton red, label "STOP"					
C = Momentary flush pushbutton black, label "FORWARD" B = Momentary flush pushbutton black, label "REVERSE" A = Momentary raised pushbutton red, label "STOP"	NEMA 4X Fiberglass	1NO, 1NC 1NO, 1NC 1NO, 1NC	3	52C301X	
C = Momentary flush pushbutton black, label "UP" B = Momentary flush pushbutton black, label "DOWN" A = Momentary raised pushbutton red, label "STOP"	NEMA 4X Fiberglass	1NO, 1NC 1NO, 1NC 1NO, 1NC	3	52C332X	
C = Momentary flush pushbutton black, label "OPEN" B = Momentary flush pushbutton black, label "CLOSE" A = Momentary raised pushbutton red, label "STOP"	NEMA 4X Fiberglass	1NO, 1NC 1NO, 1NC 1NO, 1NC	3	52C333X	
C = Momentary flush pushbutton black, label "HI" B = Momentary flush pushbutton, black label "LOW" A = Momentary raised pushbutton red, label "STOP"	NEMA 4X Fiberglass	1NO, 1NC 1NO, 1NC 1NO, 1NC	3	52C334X	

① NEMA 4X Stainless Steel Enclosure is 304 SS.

1
2
3
4
5
6
7
8
9
10

Pushbutton Units and Indicator Lights

30 mm Heavy Duty, Watertight/Oiltight, Class 52

Legend plates for Class 51 and 52

1
2
3
4
5
6
7
8
9
10

Design

The 30 mm legend plates are approved for the use with both Class 51 and Class 52 devices.
Automotive legend plates require 2 1/2" mounting centers. Plastic legend plates will have white letters engraved.

When ordering custom engraved legend plates, specify the required inscription text.

Selection and ordering data

Inscription	Large (1 7/16" x 2")	Automotive ^① (2 7/16" x 2 7/16")	Large Plastic ^② (1 7/16" x 2")	Automotive Plastic ^{②②} (2 7/16" x 2 7/16")
	Order No.	Order No.	Order No.	Order No.
"Blank (brushed aluminum)"	52NL02	52NA02	—	—
"Blank (red)"	52NL02R	52NA02R	52ND02R	52NE02R
"Blank (Black)"	52NL02B	52NA02B	52ND02B	52NE02B
Inscribed legend plates with large brushed aluminum background				
Close	52NL18	52NA18	—	—
Down	52NL10	52NA10	—	—
Emerg Stop	52NL16	52NA16	—	—
Emerg Stop (red)	52NL16R	52NA16R	—	—
Fast-Slow	52NL33	52NA33	—	—
Forward	52NL05	52NA05	—	—
For-Off-Rev	52NL38	52NA38	—	—
For-Rev	52NL31	52NA31	—	—
Hand-Off-Auto	52NL37	52NA37	—	—
High	52NL07	52NA07	—	—
High-Low	52NL30	52NA30	—	—
High-Off-Low	52NL44	52NA44	—	—
In	52NL21	52NA21	—	—
Jog	52NL13	52NA13	—	—
Jog-Forward	52NL24	52NA24	—	—
Jog-Reverse	52NL25	52NA25	—	—
Low	52NL08	52NA08	—	—
Lower	52NL20	52NA20	—	—
Man-Auto	52NL35	52NA35	—	—
Off	52NL12	52NA12	—	—
Off-On	52NL26	52NA26	—	—
On	52NL11	52NA11	—	—
On-Off-Auto	52NL40	52NA40	—	—
Open	52NL17	52NA17	—	—
Open-Close	52NL34	52NA34	—	—
Open-Off-Close	52NL41	52NA41	—	—
Out	52NL22	52NA22	—	—
Pull to Start Push to Stop	52NL47	52NA47	—	—
Raise	52NL19	52NA19	—	—
Raise-Lower	52NL36	52NA36	—	—
Reset	52NL14	52NA14	—	—
Reverse	52NL06	52NA06	—	—
Run	52NL23	52NA23	—	—
Run-Jog	52NL29	52NA29	—	—
Safe-Run	52NL27	52NA27	—	—
Slow-Off-Fast	52NL39	52NA39	—	—
Start	52NL03	52NA03	—	—
Start-Jog	52NL28	52NA28	—	—
Start-Stop	52NL32	52NA32	—	—
Stop	52NL04	52NA04	—	—
Stop (red)	52NL04R	52NA04R	—	—
Up	52NL09	52NA09	—	—
Up-Down	52NL49	52NA49	—	—
Up-Off-Down	52NL42	52NA42	—	—
Inscription plates with custom engraving				
"Custom engraved (brushed aluminum)"	52NL02E	52NA02E	—	—
"Custom engraved (red)"	52NL02RE	52NA02RE	52ND02RE	52NE02RE
"Custom engraved (Black)"	52NL02BE	52NA02BE	52ND02BE	52NE02BE
Max. number of rows	2	2	2	2
Letter height	5/32"	1/4"	5/32"	1/4"
Characters per row	14	16	14	16

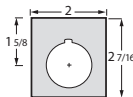
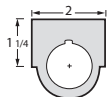

① Automotive requires 2 1/2" mounting centers
② White letters on plastic nameplate.

Pushbutton Units and Indicator Lights

30mm Heavy Duty, Watertight/Oiltight, Class 52

Dimensional drawings

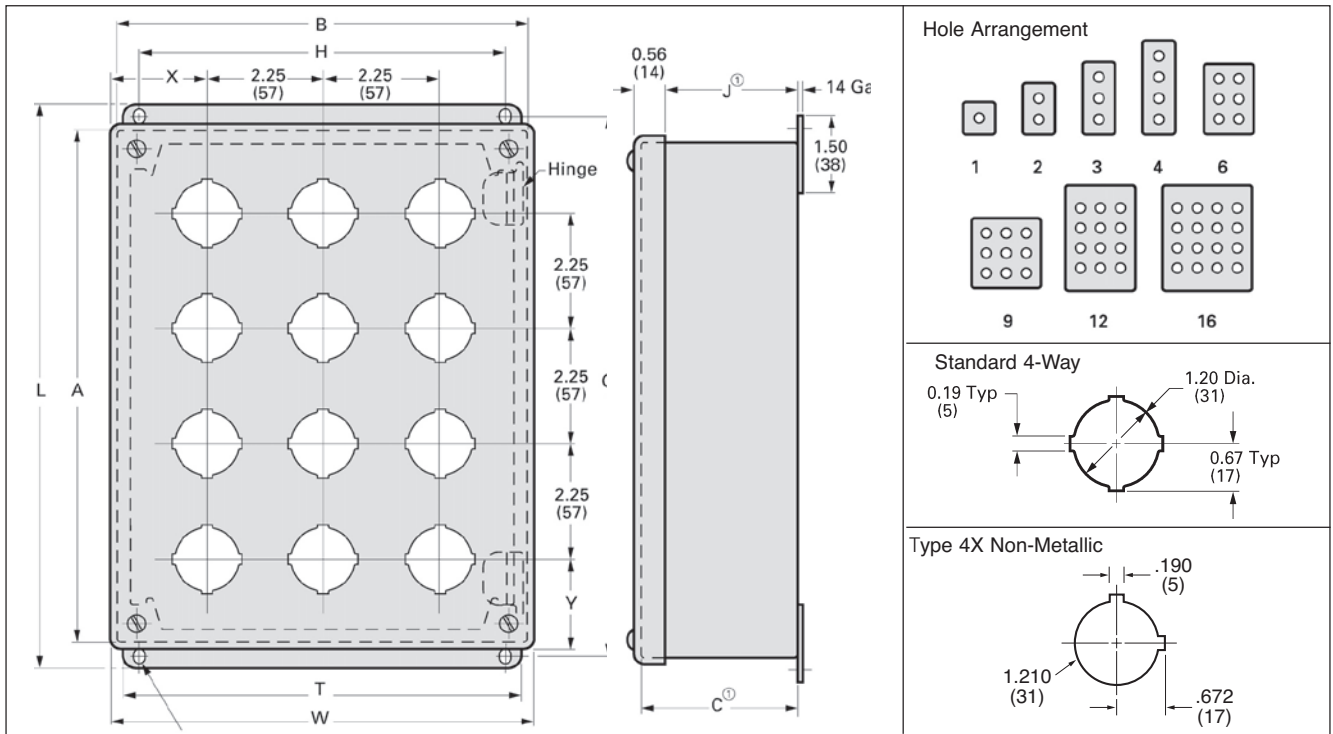

Type 12/13 and 4X Stainless Steel

Units	Enclosure Size			Mounting		Overall					
	A	B	C	G	H	L	W	J	T	X	Y
1	3.50 (89)	3.25 (83)	2.75 (70)	4.00 (102)	2.38 (60)	4.50 (114)	3.47 (88)	2.31 (59)	3.00 (76)	1.73 (44)	1.86 (47)
2	5.75 (146)	3.25 (83)	2.75 (70)	6.25 (159)	2.38 (60)	6.75 (171)	3.47 (88)	2.31 (59)	3.00 (76)	1.73 (44)	1.86 (47)
3	8.00 (203)	3.25 (83)	2.75 (70)	8.50 (216)	2.38 (60)	9.00 (229)	3.47 (88)	2.31 (59)	3.00 (76)	1.73 (44)	1.86 (47)
4	10.25 (260)	3.25 (83)	2.75 (70)	10.75 (273)	2.38 (60)	11.25 (286)	3.47 (88)	2.31 (59)	3.00 (76)	1.73 (44)	1.86 (47)
6	9.50 (241)	6.25 (159)	3.00 (76)	10.00 (254)	5.38 (137)	10.50 (267)	6.47 (164)	2.56 (65)	6.00 (152)	2.11 (54)	2.61 (66)
9	9.50 (241)	8.50 (216)	3.00 (76)	10.00 (254)	7.62 (194)	10.50 (267)	8.72 (221)	2.56 (65)	8.25 (210)	2.11 (54)	2.61 (66)
12	11.75 (298)	8.50 (216)	3.00 (76)	12.25 (311)	7.62 (194)	12.75 (324)	8.72 (221)	2.56 (65)	8.25 (210)	2.11 (54)	2.61 (66)
16 ²⁾	11.75 (298)	10.75 (273)	3.00 (76)	12.25 (311)	9.88 (251)	12.75 (324)	10.97 (279)	2.56 (65) ²⁾	10.50 (267)	2.11 (54)	2.61 (66)

Type 12/13 Extra Deep Enclosures

Units	Enclosure Size			Mounting		Overall					
	A	B	C	G	H	L	W	J	T	X	Y
1	4.00	4.00	4.75	4.50	3.12	5.00	4.22	4.31	3.75	2.11	2.11
2	6.00	4.00	4.75	6.50	3.12	7.00	4.22	4.31	3.75	2.11	1.98
3	8.00	4.00	4.75	8.50	3.12	9.00	4.22	4.31	3.75	2.11	1.86
4	10.00	4.00	4.75	10.50	3.12	11.00	4.22	4.31	3.75	2.11	1.73
6	9.50	6.25	4.75	10.00	5.38	10.50	6.47	4.31	6.00	2.11	2.61
9	9.50	8.50	4.75	10.00	7.62	10.50	8.72	4.31	8.25	2.11	2.61
12	11.75	8.50	4.75	12.25	7.62	12.75	8.72	4.31	8.25	2.11	2.61
16 ²⁾	11.75	10.75	4.75	12.25	9.88	12.75	10.97	4.31	10.50	2.11	2.61

Type 4X Non-Metallic

Units	Enclosure Size		Mounting		Overall		
	A	B	C	G	H	L	W
1	6.00	3.19	3.63	4.88	2.94	6.63	3.81
2	6.00	3.19	3.63	4.88	2.94	6.63	3.81
3	8.26	3.19	3.63	7.13	2.94	8.88	3.81
4	10.51	3.19	3.63	9.37	2.94	11.13	3.81

All dimensions shown in inches and (millimeters). For reference purposes only. Not to be used for design or construction purposes.

- 1) Grounding stud in body of enclosure.
- 2) For stainless steel add 1.75 (45) to depth.

Pushbutton Units and Indicator Lights

30 mm Pilot Devices

Technical Specifications

Standards	UL Listed File # E22655	CSA Certified File # LR6535
Utilization	Category NEMA	A600/P600
Degree of Protection	52B, 52P-, 52S-, 52M- Operators	NEMA: 1, 3, 3R, 4, 4X, 12 and 13 IEC 529; IP10, IP11, IP14, IP52, IP54, IP56 and IP66

Rated Operational Current

NEMA A600 – 10 Continuous Amps			NEMA P600 – Rating Codes for DC Control Circuit Application	
Voltage AC	Make Amps	Break Amps	Thermal Continuous Test Current Amps	Maximum Make or Break; Current / Amps
120V	60	6	125V	5.0
240V	30	3	250V	1.10
480V	15	1.5	301-600V	0.55
600V	12	1.2		0.20
Total VA	7200	720	Maximum Make or Break Volt amperes at 300V or Less	138

Contact Blocks	52BAK, -BAJ [Ⓞ] , -BAH, -BAU, -BJK [Ⓞ] 52BAR	600VAC Maximum, Heavy Duty 200VAC .25 Amp, 10 Watt Maximum 200VDC .50 Amp, 10 Watt Maximum
-----------------------	---	--

[Ⓞ]  Positively driven contacts. Contact blocks are suitable for applications down to 5V/1MA low voltage applications as found in PLCs. 52BAR are Class 1; Division 2 Compliant

Pilot Light	Full Voltage LED Module Transformer Type	52PL4/52PL5 or 52BL4/52BL5	-B (6-8V), -C (12V), -D (24V), -E (120V) -L (24V), -M (120V) -N (240V) -G (120V), -H (240V), -J (480V), -K (600V)	120V AC Max. 240V AC Max. 600V AC Max., 50/60 Hz
Push-to-Test	Full Voltage LED Module Transformer Type	52PT6 or 52BT6	-B (6-8V), -C (12V), -D (24V), -E (120V) -L (24V), -M (120V), -N (240V) -G (120V), -H (240V), -J (480V), -K (600V)	120V AC Max. 240V AC Max. 600VAC Max., 50/60 Hz
Illuminated Push-Pull	Full Voltage LED Module Transformer	52PP2(3,7) or 52BP2(3,7)	-B (6-8V), -C (12V), -D (24V), -E (120V) -L (24V), -M (120V), -N (240V) -G (120V), -H (240V), -J (480V), -K (600V)	120V AC Max. 240V AC Max. 600VAC Max., 50/60 Hz
Illuminated Selector Switch	Full Voltage Transformer	52SA7(A,B,C) or 52SX7(A,B,C)	-B (6-8V), -C (12V), -D (24V), -E (120V) -G (120V), -H (240V), -J (480V), -K (600V)	120V AC Max. 600V AC Max., 50/60 Hz

Dielectric Strength 2200V for one minute

Mechanical Design Life Cycles

Vibration	Frequency 5 - 60Hz.; Disp. .030 inches, sweep 5 minutes for a duration of 30 minutes on each axis. Not to exceed 5.5 G's for maximum of 1 minute.
Pushbuttons	Momentary, Non-illuminated 5,000,000 Operating Cycles Momentary, Illuminated 300,000 Operating Cycles
Push-Pull	Maintained 300,000 Operating Cycles Momentary 2,000,000 Operating Cycles
Twist-to-Release	300,000 Operating Cycles
Selector Switches	Non-illuminated 2,000,000 Operating Cycles Illuminated, Key-operated 2,000,000 Operating Cycles
Contact Operation	Standard Contact Black Logic Reed
Wire Gauge	#18-12 AWG
Terminal Screw Torque	2-10 lb-in / 20 lb-in max; 8 lb-in recommended
Locknut Torque	15 ft. lbs. max
Temperature Range	Operating 31F to +158F (-35C to +70C) Storage 40F to +185F (-40C to +85C)

All parts are designed and manufactured of corrosion resistant material or are plated or painted as corrosion protection. All contact block contacts are gold flashed as a standard offering. Internal return spring mechanisms of operators and contact blocks of stainless steel. RoHS Compliant.

Declaration of Conformity — The products listed below, to which this declaration relates, are in conformity with the following standards, following the provisions of the Low Voltage Directive (LVD) (73/23/EEC), and the Electromagnetic Compatibility Directive (89/336/EEC.)

Products: Contact Blocks: Cat Nos. 52BAE, 52BAH, 52BAJ, 52BAK, 52BAR, 52BAU and 52BJK, with suffixes. Pilot Lights: Cat Nos 52P, with suffixes. Operators: Cat Nos 52S or 52P, with suffixes.

Applicable Standards: EN 60947-5-1 Low-Voltage Switchgear and controlgear. Enclosed devices meet the requirements of environmental ratings of IP10, IP11, IP14, IP52, IP54, and IP56. Open devices, when mounted as instructed, in environmental type IP10, IP11, IP14, IP52, IP54 or IP56 enclosures, maintain the environmental requirements for those enclosure types. Cat. No. 52BP, 52BR, 52PP, and 52PR, 2 Position, Twist-To-Release and 2 Position, Push Pull Maintained operators provided with red operating heads and 52BJK contact blocks meet the requirements of EN 60947-5-5 for Electrical Emergency Stop Device With Mechanical Latching Function (e-stop).

Pushbutton Units and Indicator Lights

Notes