

Pushbutton Units and Indicator Lights

Class 50 Standard Duty Pushbutton Stations

General

Features

- Snap In Legend Inserts
- Flush and Surface Mounted Types
- Convertible Selector
- Double Break Contacts
- Dual Voltage Pilot Light with Snap In Lens
- Conversion Kits
- UL Listed File #E22655
- CSA Certified File #LR6535

Application

Standard duty control stations are used with magnetic controllers to control the starting, stopping, reversing or speed of applicable motors.

Stations are assembled of one, two or three push button, selector switch or pilot light units in a variety of combinations to provide compact control units for remote control of magnetic starters and contactors.

Station enclosures are available in Type 1 surface mounted, 1B flush plate mounted and 4 watertight.

Features

Type 1 surface mounted bases are constructed of 14 gauge sheet steel, primed and finished in baked gray enamel. The base is predrilled to receive a variety of contact blocks, pilot lights and accessory devices. Covers are of 20 gauge sheet steel, wrap-around construction, primed and finished in baked gray enamel. Siemens Type 4 watertight heavy duty push button stations are supplied with a provision to padlock the stop button in the depressed position. Enclosures are predrilled and tapped for 3/4" conduit.

Contact blocks have double break, fine silver contacts with a NEMA B600 rating. Type 4 stations have a NEMA A600 rating.

The pilot light assembly is dual voltage with clearly marked pressure type terminals for 120 volt or 240 volt connection.

The lens of the pilot light snaps into the cover and is available in both red and green.

Push buttons are equipped with an operator into which a selected legend insert is snapped. Legend inserts are molded thermoplastic and come in a wide variety of legends and colors.

The selector switch operator can be instantly set for two or three positions at any time.

Mushroom Head

50ZMH mounts on any standard push button operator. The Mushroom Head is red molded thermoplastic, 1 1/2" in diameter, and provides a large operator for emergency stop or similar applications.

Mechanical Interlock

50ZAM is a base mounted zinc plate, dichromate dipped, steel assembly. When mounted in conjunction with Duplex Contact Block 50ZAC3 (one NO and one NO) the interlock prevents one contact from being closed while the other contact is closed.

Padlock Attachment Kit

50ZAL can be mounted to any Type 1 surface mounted station by the lower screw which fastens the cover to the station base. Made of heavy steel, chrome plated, the attachment provides for the padlocking of a push button in the depressed position or a selector switch in any position. When used with a push button operator, raised Legend Insert D53493003 (Red Stop) must be used.

Pendant Bracket

Adapts standard Type 1 surface mounted stations for suspension from a cable or chain. Bracket 50ZAP2 is used for one and two unit stations, 50ZAP3 for three unit stations.

Electrical Ratings

NEMA AC Ratings 50/60Hz
Nema B600 5 Continuous Amps

Volts	Make	Break
120	30	3
240	15	1.5
480	7.5	0.75
600	6	0.6
VA	3600	360

Ordering Information

- Legend Inserts see page 17-235.
- Accessories see page 17-235.



2 Push Buttons
Surface Mounting, NEMA 1



2 Push Buttons
Flush Mounting, NEMA 1B



1 Push Button
Surface Mounting



1 Selector Switch
Flush Mounting



2 Push Buttons
1 Selector Switch





1 Pilot Light
2 Push Buttons

Pushbutton Units and Indicator Lights

Class 50 Standard Duty Pushbutton Stations

5A 600V AC NEMA B600

Selection and ordering data

	Operator identification	Degree of protection	Contacts / voltage	Number of command points	Order No.	List Price \$ 1 unit	Packs Unit
 <p>1 unit surface mount-momentary pushbutton</p>	A = Momentary flush pushbutton green, surface, label "START"	NEMA 1	1NO - 1NC with common jumper (50ZAC1)	1	50AA3D		1
	A = Momentary flush pushbutton red, surface, label "STOP"	NEMA 1	1NO - 1NC with common jumper (50ZAC1)	1	50AA3E		1
	A = Momentary raised pushbutton red, surface, label "STOP"	NEMA 1	1NO - 1NC with common jumper (50ZAC1)	1	50AA3F		1
	A = Momentary mushroom head red, surface, label "STOP"	NEMA 1	1NO - 1NC with common jumper (50ZAC1)	1	50AA3G		1
	A = Momentary flush pushbutton less insert, surface	NEMA 1	1NO - 1NC with common jumper (50ZAC1)	1	50AA3A		1
	A = 3 position selector switch, surface, label "HAND-OFF-AUTO"	NEMA 1	2 NO 2SPST (50ZAC8)	1	50AA3C3		1
	A = 2 position selector switch, surface, label "Off-On"	NEMA 1	2 NO 2SPST (50ZAC8)	1	50AA3C6		1
	A = 2/3 selector switch, surface, multiple legends	NEMA 1	2 NO 2SPST (50ZAC8)	1	50AA3B9		1
	A = Indicator light, red, surface	NEMA 1	120/240V dual voltage 120PSB lamp	1	50BA3Y		1
	A = Indicator light, green, surface	NEMA 1	120/240V dual voltage 120PSB lamp	1	50BA3Z		1
	A = Indicator light, less lens, surface	NEMA 1	120/240V dual voltage 120PSB lamp	1	50BA32		1
 <p>1 unit flush mount-momentary pushbutton</p>	A = Momentary flush pushbutton green, flush, label "START"	NEMA 1B	1NO - 1NC with common jumper (50ZAC1)	1	50AA2D		1
	A = Momentary flush pushbutton red, flush, label "STOP"	NEMA 1B	1NO - 1NC with common jumper (50ZAC1)	1	50AA2E		1
	A = Momentary raised pushbutton red, flush, label "STOP"	NEMA 1B	1NO - 1NC with common jumper (50ZAC1)	1	50AA2F		1
	A = Momentary flush pushbutton less insert, flush	NEMA 1B	1NO - 1NC with common jumper (50ZAC1)	1	50AA2A		1
	A = Momentary flush pushbutton less insert, flush, chrome plate	NEMA 1B	1NO - 1NC with common jumper (50ZAC1)	1	50AA6A		1
	A = 3 position selector switch, flush, label "HAND-OFF-AUTO"	NEMA 1B	2 NO 2SPST (50ZAC8)	1	50AA2C3		1
	A = 3 position selector switch, flush, label "Off-On"	NEMA 1B	2 NO 2SPST (50ZAC8)	1	50AA2C6		1
	A = 2/3 selector switch, multiple legends, flush	NEMA 1B	2 NO 2SPST (50ZAC8)	1	50AA2B9		1
	A = 2/3 selector switch, multiple legends, chrome plate, flush	NEMA 1B	2 NO 2SPST (50ZAC8)	1	50AA6B9		1
	A = Indicator light, red, flush	NEMA 1B	120/240V dual voltage	1	50BA2Y		1
	A = Indicator light, green, flush	NEMA 1B	120/240V dual voltage	1	50BA2Z		1
A = Indicator light, less lens, flush	NEMA 1B	120/240V dual voltage	1	50BA22		1	
A = Indicator light, less lens, chrome plate, flush	NEMA 1B	120PSB lamp	1	50BA62		1	
 <p>2 unit surface mount-momentary pushbutton</p>	B = Momentary pushbutton green, surface, label "START" A = Momentary pushbutton red, surface, label "STOP"	NEMA 1	1NO, 1NC (50ZAC2)	2	50CA3DE		1
	B = Momentary pushbutton green, surface, label "START" A = Momentary raised pushbutton red, surface, label "STOP"	NEMA 1	1NO, 1NC (50ZAC2)	2	50CA3DF		1
	B = Momentary pushbutton green, surface, label "START" A = Momentary mushroom head pushbutton red, surface, label "STOP"	NEMA 1	1NO, 1NC (50ZAC2)	2	50CA3DG		1
	B = Momentary pushbutton, less insert, surface A = Momentary pushbutton, less insert, surface	NEMA 1	1NO, 1NC (50ZAC2)	2	50CA3AA		1
	B = Momentary pushbutton, surface, label "FORWARD" A = Momentary pushbutton, surface, label "REVERSE"	NEMA 1	2 NO (50ZAC3)	2	50DA3KL		1

Pilot Devices

17 CONTROL PRODUCTS

Pushbutton Units and Indicator Lights

Class 50 Standard Duty Pushbutton Stations

5A 600V AC NEMA B600

Selection and ordering data

	Operator identification	Degree of protection	Contacts / voltage	Number of command points	Order No.	List Price \$ 1 unit	Packs Unit
2 unit surface mount-momentary pushbutton 	B = Momentary pushbutton, surface, label "OPEN" A = Momentary pushbutton, surface, label "CLOSE"	NEMA 1	2 NO (50ZAC3)	2	50DA3HJ		1
	B = Momentary pushbutton, surface, label "UP" A = Momentary pushbutton, surface, label "DOWN"	NEMA 1	2 NO (50ZAC3)	2	50DA3NP		1
	B = Momentary pushbutton, surface, less insert A = Momentary pushbutton, surface, less insert	NEMA 1	2 NO (50ZAC3)	2	50DA3AA		1
	B = Momentary pushbutton, surface, label "FORWARD" A = Momentary pushbutton, surface, label "REVERSE"	NEMA 1	2 NO mechanically interlocked (50ZA3C w/ 50ZAM)	2	50RA3KL		1
	B = Momentary pushbutton, surface, label "OPEN" A = Momentary pushbutton, surface, label "CLOSE"	NEMA 1	2 NO mechanically interlocked (50ZA3C w/ 50ZAM)	2	50RA3HJ		1
	B = Momentary pushbutton, surface, label "UP" A = Momentary pushbutton, surface, label "DOWN"	NEMA 1	2 NO mechanically interlocked (50ZA3C w/ 50ZAM)	2	50RA3NP		1
	B = Momentary pushbutton, surface, label "ON" A = Momentary pushbutton, surface, label "OFF"	NEMA 1	2 NO mechanically interlocked (50ZA3C w/ 50ZAM)	2	50RA334		1
	B = Momentary pushbutton, less insert surface A = Momentary pushbutton, less insert, surface	NEMA 1	2 NO mechanically interlocked (50ZA3C w/ 50ZAM)	2	50RA3AA		1
	B = Momentary pushbutton, surface, label "FORWARD" A = Momentary pushbutton, surface, label "REVERSE"	NEMA 1	2 NO, 2 NC (2 - 50ZAC2)	2	50EA3KL		1
	B = Momentary pushbutton, surface, label "OPEN" A = Momentary pushbutton, surface, label "CLOSE"	NEMA 1	2 NO, 2 NC (2 - 50ZAC2)	2	50EA3HJ		1
	B = Momentary pushbutton, surface, label "UP" A = Momentary pushbutton, surface, label "DOWN"	NEMA 1	2 NO, 2 NC (2 - 50ZAC2)	2	50EA3NP		1
	B = Momentary pushbutton, surface, label "ON" A = Momentary pushbutton, surface, label "OFF"	NEMA 1	2 NO, 2 NC (2 - 50ZAC2)	2	50EA334		1
	B = Momentary pushbutton, surface, less insert A = Momentary pushbutton, surface, less insert	NEMA 1	2 NO, 2 NC (2 - 50ZAC2)	2	50EA3AA		1
	2 unit flush mount-momentary pushbutton 	B = Momentary pushbutton green, flush, label "START" A = Momentary pushbutton red, flush, label "STOP"	NEMA 1B	1NO, 1NC (50ZAC2)	2	50CA2DE	
B = Momentary pushbutton green, flush, label "START" A = Momentary raised pushbutton red, flush, label "STOP"		NEMA 1B	1NO, 1NC (50ZAC2)	2	50CA2DF		1
B = Momentary pushbutton green, flush, label "START" A = Momentary mushroom head pushbutton red, flush, label "STOP"		NEMA 1B	1NO, 1NC (50ZAC2)	2	50CA2DG		1
B = Momentary pushbutton, less insert, flush A = Momentary pushbutton, less insert, flush		NEMA 1B	1NO, 1NC (50ZAC2)	2	50CA6AA		1

Pushbutton Units and Indicator Lights

Class 50 Standard Duty Pushbutton Stations

5A 600V AC NEMA B600

Selection and ordering data

	Operator identification	Degree of protection	Contacts / voltage	Number of command points	Order No.	List Price \$	Packs
						1 unit	Unit
2 unit flush mount-momentary pushbutton	B = Momentary pushbutton, flush, label "FORWARD" A = Momentary pushbutton, flush, label "REVERSE"	NEMA 1B	2 NO (50ZAC3)	2	50DA2KL		1
	B = Momentary pushbutton, flush, label "OPEN" A = Momentary pushbutton, flush, label "CLOSE"	NEMA 1B	2 NO (50ZAC3)	2	50DA2HJ		1
	B = Momentary pushbutton, flush, label "UP" A = Momentary pushbutton, flush, label "DOWN"	NEMA 1B	2 NO (50ZAC3)	2	50DA2NP		1
	B = Momentary pushbutton, less insert, flush A = Momentary pushbutton, less insert, flush	NEMA 1B	2 NO (50ZAC3)	2	50DA2AA		1
	B = Momentary pushbutton, less insert, chrome plate, flush A = Momentary pushbutton, less insert, chrome plate, flush	NEMA 1B	2 NO (50ZAC3)	2	50DA6AA		1
	B = Momentary pushbutton, flush, label "FORWARD" A = Momentary pushbutton, flush, label "REVERSE"	NEMA 1B	2 NO mechanically interlocked (50ZA3C w/ 50ZAM)	2	50RA2KL		1
	B = Momentary pushbutton, flush, label "OPEN" A = Momentary pushbutton, flush, label "CLOSE"	NEMA 1B	2 NO mechanically interlocked (50ZA3C w/ 50ZAM)	2	50RA2HJ		1
	B = Momentary pushbutton, flush, label "UP" A = Momentary pushbutton, flush, label "DOWN"	NEMA 1B	2 NO mechanically interlocked (50ZA3C w/ 50ZAM)	2	50RA2NP		1
	B = Momentary pushbutton, flush, label "ON" A = Momentary pushbutton, flush, label "OFF"	NEMA 1B	2 NO mechanically interlocked (50ZA3C w/ 50ZAM)	2	50RA234		1
	B = Momentary pushbutton, less insert, flush A = Momentary pushbutton, less insert, flush	NEMA 1B	2 NO mechanically interlocked (50ZA3C w/ 50ZAM)	2	50RA2AA		1
	B = Momentary pushbutton, less insert, chrome plate, flush A = Momentary pushbutton, less insert, chrome plate, flush	NEMA 1B	2 NO mechanically interlocked (50ZA3C w/ 50ZAM)	2	50RA6AA		1
	B = Momentary pushbutton, flush, label "FORWARD" A = Momentary pushbutton, flush, label "REVERSE"	NEMA 1B	2 NO, 2 NC (2 - 50ZAC2)	2	50EA2KL		1
	B = Momentary pushbutton, flush, label "OPEN" A = Momentary pushbutton, flush, label "CLOSE"	NEMA 1B	2 NO, 2 NC (2 - 50ZAC2)	2	50EA2HJ		1
	B = Momentary pushbutton, flush, label "UP" A = Momentary pushbutton, flush, label "DOWN"	NEMA 1B	2 NO, 2 NC (2 - 50ZAC2)	2	50EA2NP		1
	B = Momentary pushbutton, flush, label "ON" A = Momentary pushbutton, flush, label "OFF"	NEMA 1B	2 NO, 2 NC (2 - 50ZAC2)	2	50EA234		1
	B = Momentary pushbutton, less insert, flush A = Momentary pushbutton, less insert, flush	NEMA 1B	2 NO, 2 NC (2 - 50ZAC2)	2	50EA2AA		1
	B = Momentary pushbutton, less insert, chrome plate, flush A = Momentary pushbutton, less insert, chrome plate, flush	NEMA 1B	2 NO, 2 NC (2 - 50ZAC2)	2	50EA6AA		1

Pilot Devices

17 CONTROL PRODUCTS

Pushbutton Units and Indicator Lights

Class 50 Standard Duty Pushbutton Stations

5A 600V AC NEMA B600

Selection and ordering data

	Operator identification	Degree of protection	Contacts / voltage	Number of command points	Order No.	List Price \$	Packs			
						1 unit	Unit			
2 unit surface mount-momentary pushbutton and selector switch	B = Momentary pushbutton green, surface, label "START"	NEMA 1	1NO, 1NC (50ZAC1)	2	50FA3DC3		1			
	A = Maintained selector switch, surface, label "HAND-OFF-AUTO"		2 NO 2SPDT w/ common jumper (50ZAC8)							
	B = Momentary pushbutton less insert, surface	NEMA 1	1NO, 1NC (50ZAC1)	2				50FA3AB9		1
	A = Maintained selector switch, multiple legends, surface		2 NO 2SPDT w/ common jumper (50ZAC8)							
	B = Indicator light, red, surface	NEMA 1	120/240V dual voltage (120PSB lamp)	2						
A = Maintained selector switch, surface, label "HAND-OFF-AUTO"		2 NO 2SPDT w/ common jumper (50ZAC8)								
2 unit surface mount-momentary pushbutton and indicator light	B = Indicator light, red, surface	NEMA 1	120/240V dual voltage (120PSB lamp)	2	50HA32B9		1			
	A = Maintained selector switch, multiple legends, surface		2 NO 2SPDT w/ common jumper (50ZAC8)							
	B = Indicator light, green, surface	NEMA 1	120/240V dual voltage (120PSB lamp)	2				50GA3ZY		1
	A = Indicator light, red, surface									
	B = Indicator light, less lens, surface	NEMA 1	120/240V dual voltage (120PSB lamp)	2				50GA322		1
A = Indicator light, less lens, surface										
2 unit flush mount-momentary pushbutton and selector switch	B = Momentary pushbutton green, flush, label "START"	NEMA 1B	1NO, 1NC (50ZAC1)	2	50FA2DC3		1			
	A = Maintained selector switch, flush, label "HAND-OFF-AUTO"		2 NO 2SPDT w/ common jumper (50ZAC8)							
	B = Momentary pushbutton less insert, flush	NEMA 1B	1NO, 1NC (50ZAC1)	2				50FA2AB9		1
	A = Maintained selector switch, multiple legends, flush		2 NO 2SPDT w/ common jumper (50ZAC8)							
	B = Momentary pushbutton less insert chrome plate, flush	NEMA 1B	1NO, 1NC (50ZAC1)	2						
	A = Maintained selector switch, multiple legends, flush		2 NO 2SPDT w/ common jumper (50ZAC8)							
	B = Indicator light, red, flush	NEMA 1B	120/240V dual voltage (120PSB lamp)	2				50HA2YC3		1
	A = Maintained selector switch, flush, label "HAND-OFF-AUTO"		2 NO 2SPDT w/ common jumper (50ZAC8)							
	B = Indicator light, less lens, flush	NEMA 1B	120/240V dual voltage (120PSB lamp)	2				50HA22B9		1
	A = Maintained selector switch, multiple legends, flush		2 NO 2SPDT w/ common jumper (50ZAC8)							
B = Indicator light, less lens, chrome plate, flush	NEMA 1B	120/240V dual voltage (120PSB lamp)	2	50HA62B9		1				
A = Maintained selector switch, multiple legends, flush		2 NO 2SPDT w/ common jumper (50ZAC8)								
2 unit flush mount-momentary pushbutton and indicator light	B = Indicator light, green, flush	NEMA 1B	120/240V dual voltage (120PSB lamp)	2	50GA2ZY		1			
	A = Indicator light, red, flush									
	B = Indicator light, less lens, flush	NEMA 1B	120/240V dual voltage (120PSB lamp)	2				50GA222		1
	A = Indicator light, less lens, flush									
	B = Indicator light, less lens, chrome plate, flush	NEMA 1B	120/240V dual voltage (120PSB lamp)	2				50GA622		1
A = Indicator light, less lens, chrome plate, flush										
3 unit surface mount-momentary pushbutton	C = Momentary pushbutton, surface, label "FORWARD"	NEMA 1	2 NO, 2 NC (2 - 50ZAC2)	3	50MA3KLE		1			
	B = Momentary pushbutton, surface, label "REVERSE"		1NO - 1NC with common jumper (50ZAC1)							
	A = Momentary pushbutton, surface, label "STOP"									
	C = Momentary pushbutton, surface, label "UP"	NEMA 1	2 NO, 2 NC (2 - 50ZAC2)	3				50MA3NPE		1
	B = Momentary pushbutton, surface, label "DOWN"		1NO - 1NC with common jumper (50ZAC1)							
	A = Momentary pushbutton, surface, label "STOP"									
	C = Momentary pushbutton, surface, label "OPEN"	NEMA 1	2 NO, 2 NC (2 - 50ZAC2)	3				50MA3HJE		1
	B = Momentary pushbutton, surface, label "CLOSE"		1NO - 1NC with common jumper (50ZAC1)							
	A = Momentary pushbutton, surface, label "STOP"									

Pushbutton Units and Indicator Lights

Class 50 Standard Duty Pushbutton Stations

5A 600V AC NEMA B600

Selection and ordering data

	Operator identification	Degree of protection	Contacts / voltage	Number of command points	Order No.	List Price \$ 1 unit	Packs Unit	
3 unit surface mount-momentary pushbutton	C = Momentary pushbutton, surface, label "FAST"	NEMA 1	2 NO, 2 NC (2 - 50ZAC2) 1NO - 1NC with common jumper (50ZAC1)	3	50MA3TUE		1	
	B = Momentary pushbutton, surface, label "SLOW"							
	A = Momentary pushbutton, surface, label "STOP"							
	3 unit surface mount-momentary pushbutton and selector switch	C = Momentary pushbutton, surface, label "START"	NEMA 1	2 NO, 2 NC (2 - 50ZAC2) 1NO - 1NC with common jumper (50ZAC1)	3	50MA3DME		1
		B = Momentary pushbutton, surface, label "JOG"						
		A = Momentary pushbutton, surface, label "STOP"						
	3 unit surface mount-momentary pushbutton and selector switch	C = Momentary pushbutton, surface, label less insert	NEMA 1	2 NO, 2 NC (2 - 50ZAC2) 1NO - 1NC with common jumper (50ZAC1)	3	50MA3AAA		1
		B = Momentary pushbutton, surface, label less insert						
		A = Momentary pushbutton, surface, label less insert						
3 unit surface mount-momentary pushbutton and selector switch		C = Momentary pushbutton, surface, label "START"	NEMA 1	1 NO, 1 NC (50ZAC2) 2 NO, 2 SPST with common jumper (50ZAC8)	3	50LA3DEC3		1
		B = Momentary pushbutton, surface, label "STOP"						
		A = Maintained selector switch, surface, label "HAND-OFF-AUTO"						
3 unit surface mount-momentary pushbutton and selector switch		C = Momentary pushbutton, less insert, surface	NEMA 1	1 NO, 1 NC (50ZAC2) 2 NO, 2 SPST with common jumper (50ZAC8)	3	50LA3AAB9		1
		B = Momentary pushbutton, less insert, surface						
		A = Maintained selector switch, multiple legends, surface						
	3 unit surface mount-momentary pushbutton and indicator light	C = Indicator light, red, surface	NEMA 1	120/240V dual voltage (120PSB lamp) 1 NO, 1 NC (50ZAC2)	3	50JA3YDE		1
		B = Momentary pushbutton, surface, label "START"						
		A = Momentary pushbutton, surface, label "STOP"						
	3 unit surface mount-momentary pushbutton and indicator light	C = Indicator light, green, surface	NEMA 1	120/240V dual voltage (120PSB lamp) 1 NO, 1 NC (50ZAC2)	3	50JA3ZDE		1
		B = Momentary pushbutton, surface, label "START"						
		A = Momentary pushbutton, surface, label "STOP"						
3 unit surface mount-momentary pushbutton and indicator light	C = Indicator light, less lens, surface	NEMA 1	120/240V dual voltage (120PSB lamp) 1 NO, 1 NC (50ZAC2)	3	50JA32AA		1	
	B = Momentary pushbutton, less insert, surface							
	A = Momentary pushbutton, less insert, surface							
3 unit surface mount-momentary pushbutton and indicator light	C = Indicator light, green, surface	NEMA 1	120/240V dual voltage (120PSB lamp) 2 NO, 2 SPST with common jumper (50ZAC8)	3	50NA3ZYC3		1	
	B = Indicator light, red, surface							
	A = Maintained selector switch, surface, label "HAND-OFF-AUTO"							
3 unit surface mount-momentary pushbutton and indicator light	C = Indicator light, less lens, surface	NEMA 1	120/240V dual voltage (120PSB lamp) 2 NO, 2 SPST with common jumper (50ZAC8)	3	50NA322B9		1	
	B = Indicator light, less lens, surface							
	A = Maintained selector switch, multiple legends, surface							



Pilot Devices

17 CONTROL PRODUCTS

Pushbutton Units and Indicator Lights

Class 50 Standard Duty Pushbutton Stations

Heavy Duty - 10A 600V NEMA A600

Selection and ordering data

Operator identification	Degree of protection	Contacts / voltage	Number of command points	Order No.	List Price \$	Packs
					1 unit	Unit
	A = Momentary pushbutton green, surface, label "START"	NEMA 4	1NO - 1NC	1	50HA1E1	1
	A = Momentary pushbutton red, surface, label "STOP"	NEMA 4	1NO - 1NC	1	50HA1E2	1
	A = Momentary pushbutton green, surface, label "RESET"	NEMA 4	1NO - 1NC	1	50HA1E4	1
	A = Momentary pushbutton green, surface, label "JOG"	NEMA 4	1NO - 1NC	1	50HA1E5	1
	A = Maintained selector switch, surface, label "SAFE-RUN"	NEMA 4	1NO - 1NC	1	50HA1E6	1
	A = Maintained selector switch, surface, label "OFF-ON"	NEMA 4	1NO - 1NC	1	50HA1E7	1
	A = Maintained selector switch, surface, label "JOG-RUN"	NEMA 4	1NO - 1NC	1	50HA1E8	1
	A = Maintained selector switch, surface, label "HAND-OFF-AUTO"	NEMA 4	1NO - 1NC	1	50HA1E9	1
		B = Momentary pushbutton green, surface, label "START"	NEMA 4	1NO - 1NC	2	50HA2E1
A = Momentary pushbutton red, surface, label "STOP"						
B = Momentary pushbutton green, surface, label "FORWARD"		NEMA 4	1NO - 1NC	2	50HA2E2	1
A = Momentary pushbutton red, surface, label "REVERSE"						
B = Momentary pushbutton green, surface, label "UP"		NEMA 4	1NO - 1NC	2	50HA2E3	1
A = Momentary pushbutton red, surface, label "DOWN"						
B = Momentary pushbutton green, surface, label "OPEN"		NEMA 4	1NO - 1NC	2	50HA2E4	1
A = Momentary pushbutton red, surface, label "CLOSE"						
B = Momentary pushbutton green, surface, label "FAST"		NEMA 4	1NO - 1NC	2	50HA2E5	1
A = Momentary pushbutton red, surface, label "SLOW"						
	C = Momentary pushbutton green, surface, label "FORWARD"	NEMA 4	1NO - 1NC	3	50HA3E1	1
	B = Momentary pushbutton green, surface, label "REVERSE"					
	A = Momentary pushbutton red, surface, label "STOP"					
	C = Momentary pushbutton green, surface, label "UP"	NEMA 4	1NO - 1NC	3	50HA3E2	1
	B = Momentary pushbutton green, surface, label "DOWN"					
	A = Momentary pushbutton red, surface, label "STOP"					
	C = Momentary pushbutton green, surface, label "OPEN"	NEMA 4	1NO - 1NC	3	50HA3E3	1
	B = Momentary pushbutton green, surface, label "CLOSE"					
	A = Momentary pushbutton red, surface, label "STOP"					
	C = Momentary pushbutton green, surface, label "START"	NEMA 4	1NO - 1NC	3	50HA3E9	1
	B = Momentary pushbutton green, surface, label "JOG"					
	A = Momentary pushbutton red, surface, label "STOP"					
C = Momentary pushbutton green, surface, label "FAST"	NEMA 4	1NO - 1NC	3	50HA3E4	1	
B = Momentary pushbutton green, surface, label "SLOW"						
A = Momentary pushbutton red, surface, label "STOP"						

Pushbutton Units and Indicator Lights



Class 50 Standard Duty Pushbutton Stations

Standard Duty Station Accessories

Selection and ordering data

Legend inscription insert for snap-on mounting

Inscription	Color	Order No.	List Price \$ 1 unit	Pack Unit
Close	Orange	50D53493005		1
Down	Orange	50D53493010		1
Fast	Black	50D53493013		1
Forward	Green	50D53493006		1
High	Black	50D53493015		1
Hoist	Green	50D53493011		1
Jog	Black	50D53493008		1
Low	Black	50D53493016		1
Lower	Orange	50D53493012		1
Off	Red	50D53493018		1
On	Green	50D53493017		1
Open	Green	50D53493004		1
Reverse	Orange	50D53493007		1
Slow	Black	50D53493014		1
Start	Green	50D53493001		1
Stop	Red	50D53493002		1
Stop (raised)	Red	50D53493003		1
Up	Green	50D53493009		1

Version	Suitable for	Color	Order No.	List Price \$ 1 unit	Pack Unit
 50ZAC1	Mushroom head	Red	50ZMH		1
 50ZAC2	Padlock attachment	Used only for raised buttons	50ZAL		1
	Mechanical interlock kit		50ZAM		1
 50ZAC8	Contact blocks				
	1NO, 1NC	Single button	50ZAC1		1
	2NO, 2SPST	Selector switch	50ZAC8		1
	1NO, 1NC	Two button	50ZAC2		1
	1NO, 1NO	Two button	50ZAC3		1
	Pilot light	120/240V Dual Voltage, no lens	50ZAC6		1
	Pilot light lens	Red	50ZPL01		1
		Green	50ZPL02		1
	Pendant Bracket	1 & 2 unit station	50ZAP2		1
		3 unit station	50ZAP3		1
	Replacement lamps	Class 50 type 1, 1B 120V	50D21983001		1
	Slide base, lamp type 120PSB				

Heavy Duty Station Accessories

Version	Suitable for	Color	Order No.	List Price \$ 1 unit	Pack Unit
	Pushbutton caps				
	NEMA 4 control stations	Red	BHP15X		1
	NEMA 4 control stations	Black	BHP16X		1

Pilot Devices

17 CONTROL PRODUCTS

Pushbutton Units and Indicator Lights

Class 50 Standard Duty Pushbutton Stations

Standard Duty - 5A 600V NEMA B600

Dimension drawings

1 Unit Station Surface Mounting—Type 1

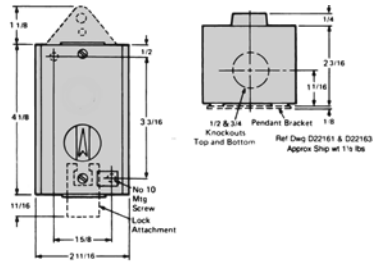

1 Unit Station Flush Mounting—Type 1B

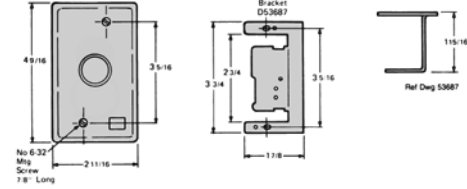

2 Pushbutton Stations Surface Mounting—Type 1

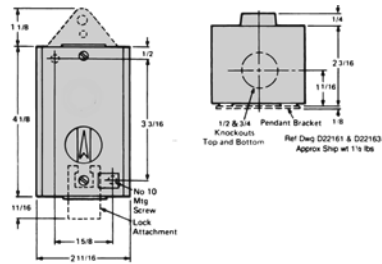

2 Pushbutton Stations Flush Mounting—Type 1B

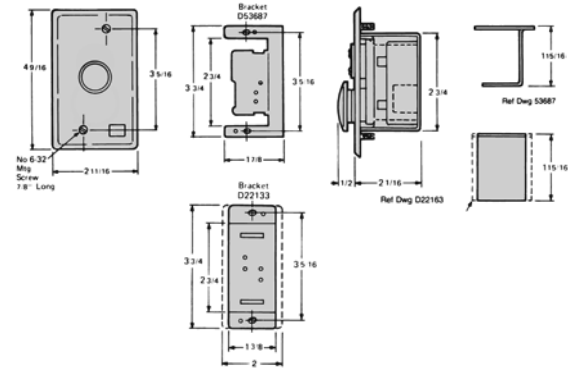

2 Unit Stations Surface Mounting—Type 1

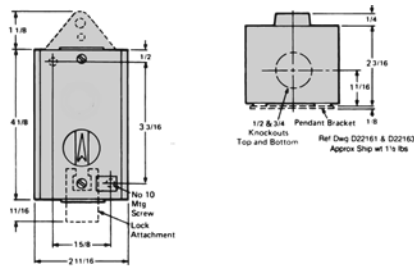

2 Unit Station Flush Mounting—Type 1B

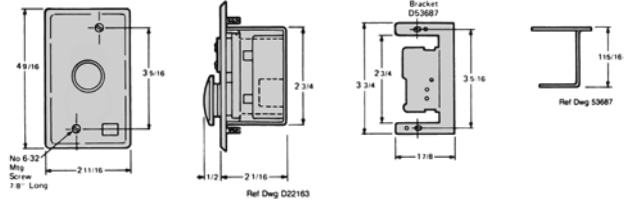

3 Unit Stations Surface Mounting

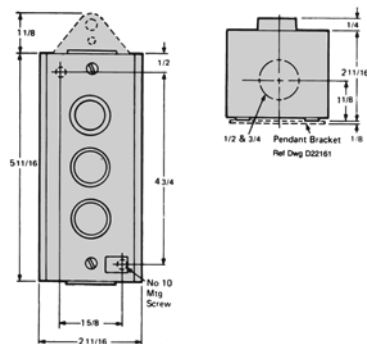

1 Unit Stations—Type 4

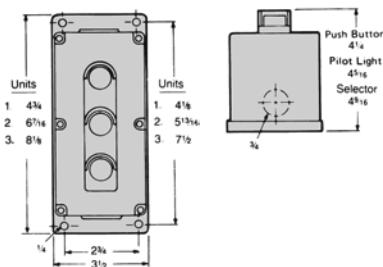

Pushbutton Units and Indicator Lights

30 mm Heavy Duty, Watertight/Oiltight, Class 52

Features

- Octagonal Mounting Nuts
- Meets Type 1, 3, 3R, 4, 4X, 12, 13 and Automotive Standards
- Heavy Duty Rated NEMA A600/P600 Contacts
-  Positively Driven Contacts
- Positive Indexing Selectors
- Bifurcated Movable Contacts
- Attractive Chrome Plating
- Boots Not Required for Type 4
- UL Listed File # E22655
- CSA Certified File # LR6535
- Touchsafe Terminals

Application

Oil tight pilot controls and accessories are designed to provide long, trouble free service in the most demanding industrial applications. These controls are oil and dust tight and meet Type 3, 4, 4X, 12 and 13 specifications.

Rugged

Industrial control operators are durable one piece castings. Heavy duty plastic buttons resist oils and corrosion. Silver contacts carry heavy duty ratings.

Flexible

Accessories modify standard push buttons, selector switches and pilot lights. Building block construction of contact blocks makes possible many circuitry combinations.

Industrial Appearance

Pilot controls add luster to panels. Chrome plating covers exposed metal parts.

Push Button Operators

The Operator Base consists of a durable, one piece casting equipped with a heavy duty actuator with a stainless steel spring, a neoprene actuator sealing ring to prevent oil and dust from penetrating to the contact blocks, a neoprene gasket to seal operator mounting hole and a chrome plated lock nut.

Mushroom Head Push Button Operators

The Mushroom Head base construction is identical to the push button base. The actuator is molded of high impact material for either a 1 5/8 inch or 2 1/2 inch diameter molded head.

E-STOP Mushroom Head Operators according to EN 60947-5-5 Cat. No. 52BP, 52BR, 52PP, and 52PR, 2 Position, Twist-To-Release & 2 Position, Push Pull Maintained operators provided with red operating heads and 52BJK contact blocks meet the requirements of EN 60947-5-5 for Electrical Emergency Stop Device With Mechanical Latching Function (e-stop).

Contact Blocks

Contact Blocks have double break bifurcated silver contacts, with gold flashing as standard, which improves contact reliability. Contact blocks are heavy duty rated NEMA A600 and suitable for applications down to 5V/1MA solid state outputs. 52BJK offers  Positive Opening Contacts according to IEC 60947-5-1, Appendix K. Molded bodies and pushers resist arcing and tracking. All units have stainless steel springs that resist corrosion and provide strong contact pressure. Captive mounting screws speed panel assembly.

Push Pull Operators

Push Pull Operators combine two or three functions in one unit. The maintained operator has two positions, typically pull to start, push to stop. The momentary operator with three positions provides spring return from both pull and push positions. In addition, a three position push maintained, pull momentary operator is available. The actuator come is 1 3/4 inch or 2 1/2 inch diameter and is available in an illuminated version.

2 Button Maintained Operator

Maintained Push Buttons consist of two push buttons and a latching assembly. When actuated the button remains depressed and is freed only by the release operator to which it is linked. The button assembly adjusts for mounting from a 1 13/16 inch to a 2 5/8 inch center.

Transformer Type Pilot Lights

Transformer Type Pilot Lights are available with a 120, 240, 480 or 600 Volt primary (50/60 Hertz) and a separate secondary winding which supplies reduced voltage to a miniature bayonet base 6 Volt lamp. These units are suitable for applications where vibration is present and long bulb life is desirable.

Full Voltage Type Pilot Lights

Full Voltage Pilot Lights are available for 6, 12, 24 and 120 Volt AC and DC applications.

Pushbutton Complete Units

Electrical Ratings

NEMA AC Ratings 50/60Hz
NEMA A600 10 Continuous Amps

Volts	Make	Break
120	60	6
240	30	3
480	15	1.5
600	12	1.2
VA	7200	720

Ordering Information

- Accessories see page 17-268 – 17-271.
- Selector Position and Contact Operation page 17-266.
- Legend Plates see page 17-278.
- Enclosures see page 17-277.

Resistor Type Pilot Lights

Resistor Type Pilot Lights are available for 240 Volt AC and DC applications. The 240 Volt pilot light is supplied with a 120 Volt lamp and a voltage dropping resistor.

LED Type Pilot Lights

LED's (light emitting diodes) can be used in pilot lights instead of incandescent bulbs because of their long life (up to 10 years), resistance to vibration and ambient sensitivity. Clusted LED options are available for standard pilot lights only. Cluster LED options are not available on Push to test Pilot Lights, Illuminated Pushbuttons, Push-pull, or Twist-to-Release Operators.

Integrated LED Module Type Pilot Lights

The integrated LED module is available for 24, 120, and 240 V. LED modules are vibration resistant and have a long life (up to 10 years). The integrated LED module is available for 24, 120, and 240 V. LED modules are vibration resistant and have a long life (up to 10 yrs.).

Selector Operators

Selector Operators have positive action indexing. Operators are available with either a short or long lever. The molded black lever is designed to accept a color insert. A white insert is provided as standard. Each operator is equipped with a cam to actuate plungers of contact blocks assembled behind the operator. Two, three and four position operators are available with seven different cams.

Lever color inserts are available in 8 colors.



Pilot Light



Push Button



Selector Operator





Selector Push Operation

Pushbutton Units and Indicator Lights

30 mm Heavy Duty, Watertight/Oiltight, Class 52

Pushbutton Complete Units

Selection and ordering data

Version	Color of actuator	Contact blocks	Flush cap order no.	Extended cap order no.	List Price	Mushroom head order no.	List Price	Pack
					\$		\$	Unit
Pushbutton unit with assembled contact blocks^①	black	1 NO	52PA8A1K	52PA8B1K		52PB9□1K		1
	red	1 NO	52PA8A2K	52PA8B2K		52PB9□2K		
	green	1 NO	52PA8A3K	52PA8B3K		52PB9□3K		
	yellow	1 NO	52PA8A4K	52PA8B4K		52PB9□4K		
Pushbutton with flush cap 	blue	1 NO	52PA8A5K	52PA8B5K		52PB9□5K		
	gray	1 NO	52PA8A6K	52PA8B6K		52PB9□6K		
	orange	1 NO	52PA8A8K	52PA8B8K		52PB9□8K		
	black	1 NC	52PA8A1J	52PA8B1J		52PB9□1J		1
Pushbutton with extended cap 	red	1 NC	52PA8A2J	52PA8B2J		52PB9□2J		
	green	1 NC	52PA8A3J	52PA8B3J		52PB9□3J		
	yellow	1 NC	52PA8A4J	52PA8B4J		52PB9□4J		
	blue	1 NC	52PA8A5J	52PA8B5J		52PB9□5J		
Pushbutton with 2 1/2" mushroom head 	gray	1 NC	52PA8A6J	52PA8B6J		52PB9□6J		
	orange	1 NC	52PA8A8J	52PA8B8J		52PB9□8J		
	black	1 NO + 1 NC	52PA8A1A	52PA8B1A		52PB9□1A		1
	red	1 NO + 1 NC	52PA8A2A	52PA8B2A		52PB9□2A		
Pushbutton with 2 1/2" mushroom head	green	1 NO + 1 NC	52PA8A3A	52PA8B3A		52PB9□3A		
	yellow	1 NO + 1 NC	52PA8A4A	52PA8B4A		52PB9□4A		
	blue	1 NO + 1 NC	52PA8A5A	52PA8B5A		52PB9□5A		
	gray	1 NO + 1 NC	52PA8A6A	52PA8B6A		52PB9□6A		
Pushbutton with 2 1/2" mushroom head	orange	1 NO + 1 NC	52PA8A8A	52PA8B8A		52PB9□8A		
	black	2 NO	52PA8A1F	52PA8B1F		52PB9□1F		1
	red	2 NO	52PA8A2F	52PA8B2F		52PB9□2F		
	green	2 NO	52PA8A3F	52PA8B3F		52PB9□3F		
Pushbutton with 2 1/2" mushroom head	yellow	2 NO	52PA8A4F	52PA8B4F		52PB9□4F		
	blue	2 NO	52PA8A5F	52PA8B5F		52PB9□5F		
	gray	2 NO	52PA8A6F	52PA8B6F		52PB9□6F		
	orange	2 NO	52PA8A8F	52PA8B8F		52PB9□8F		
Pushbutton with 2 1/2" mushroom head	black	2 NC	52PA8A1G	52PA8B1G		52PB9□1G		1
	red	2 NC	52PA8A2G	52PA8B2G		52PB9□2G		
	green	2 NC	52PA8A3G	52PA8B3G		52PB9□3G		
	yellow	2 NC	52PA8A4G	52PA8B4G		52PB9□4G		
Pushbutton with 2 1/2" mushroom head	blue	2 NC	52PA8A5G	52PA8B5G		52PB9□5G		
	gray	2 NC	52PA8A6G	52PA8B6G		52PB9□6G		
	orange	2 NC	52PA8A8G	52PA8B8G		52PB9□8G		
	black	2 NO + 2 NC	52PA8A1B	52PA8B1B		52PB9□1B		1
Pushbutton with 2 1/2" mushroom head	red	2 NO + 2 NC	52PA8A2B	52PA8B2B		52PB9□2B		
	green	2 NO + 2 NC	52PA8A3B	52PA8B3B		52PB9□3B		
	yellow	2 NO + 2 NC	52PA8A4B	52PA8B4B		52PB9□4B		
	blue	2 NO + 2 NC	52PA8A5B	52PA8B5B		52PB9□5B		
Pushbutton with 2 1/2" mushroom head	gray	2 NO + 2 NC	52PA8A6B	52PA8B6B		52PB9□6B		
	orange	2 NO + 2 NC	52PA8A8B	52PA8B8B		52PB9□8B		

Order no. change
 Small operating head - 1 5/8" (41.3 mm)
 Large operating head - 2.5" (63.5 mm)





① For other contact block assemblies replace the 8th digit catalog number as follows:
 C = 3 NO + 3NC
 D = 4 NO + 4NC
 E = 1 NC (EB)
 H = 1 NO (EM)

Pushbutton Units and Indicator Lights

30 mm Heavy Duty, Watertight/Oiltight, Class 52

Push Pull Complete Units

Selection and ordering data

	Version	Color of actuator	Contact blocks	Order no.	List Price	Order no.	List Price	Pack
				Plastic Head	\$	Metal Head	\$	Unit
	2 Position Push Pull, Maintained^① Non-Illuminated 1 3/4" (44.5 mm) mushroom head	less operating head	1NO - 1NC	52PP2WZA		52PP2AZA		1
		red	1NO - 1NC	52PP2W2A		52PP2A2A		
		green	1NO - 1NC	52PP2W3A		52PP2A3A		
		yellow	1NO - 1NC	52PP2W4A		—		
		chrome	1NO - 1NC	—		52PP2ACA		
	2 1/2" (63.5 mm) mushroom head	less operating head	1NO - 1NC	52PP2VZA				1
		red	1NO - 1NC	52PP2V2A				
		green	1NO - 1NC	52PP2V3A				
		yellow	1NO - 1NC	52PP2V4A				
		chrome	1NO - 1NC	—				
	3 Position Push Pull, Momentary Non-Illuminated (Pull to start, push to stop) ^① 1 3/4" (44.5 mm) mushroom head	less operating head	1NO - 1NC	52PP3WZU		52PP3AZU		1
		red	1NO - 1NC	52PP3W2U		52PP3A2U		
		green	1NO - 1NC	52PP3W3U		52PP3A3U		
		yellow	1NO - 1NC	52PP3W4U		—		
		chrome	1NO - 1NC	—		52PP3ACU		
	2 1/2" (63.5 mm) mushroom head	less operating head	1NO - 1NC	52PP3VZU				1
		red	1NO - 1NC	52PP3V2U				
		green	1NO - 1NC	52PP3V3U				
		yellow	1NO - 1NC	52PP3V4U				
		chrome	1NO - 1NC	—				
	3 Position Push Pull, Push Maintained, Pull Momentary Non-Illuminated (Pull to start, push to stop) ^① 1 3/4" (44.5 mm) mushroom head	less operating head	1NO - 1NC	52PP7WZU		52PP7AZU		1
		red	1NO - 1NC	52PP7W2U		52PP7A2U		
		green	1NO - 1NC	52PP7W3U		52PP7A3U		
		yellow	1NO - 1NC	52PP7W4U		—		
		chrome	1NO - 1NC	—		52PP7ACU		
2 1/2" (63.5 mm) mushroom head	less operating head	1NO - 1NC	52PP7VZU				1	
	red	1NO - 1NC	52PP7V2U					
	green	1NO - 1NC	52PP7V3U					
	yellow	1NO - 1NC	52PP7V4U					
	chrome	1NO - 1NC	—					

Color options^②: black
blue
grey
orange

1
5
6
8

① Blocks cannot be interchanged (start-stop circuit).

② To order a color option, replace the 7th digit of the order number.



③ EMERGENCY-STOP control devices according to IEC 60947-5-5 when provided with red operating head and 52BJK contact blocks.

Pushbutton Units and Indicator Lights

30 mm Heavy Duty, Watertight/Oiltight, Class 52

Push pull complete units

Selection and ordering data

	Version	Color of actuator	Contact blocks	Order no.	List Price	Order no.	List Price	Pack
				Plastic Head	\$	Metal Head	\$	Unit
2 Position push-pull illuminated	2 Position Push Pull, Maintained^④ Illuminated, Integrated LED Module 24 V AC/DC 1 3/4" (44.5 mm) mushroom head	red	1NO - 1NC	52PP2LRA		52PP2L2A		1
		green amber	1NO - 1NC 1NO - 1NC	52PP2LSA 52PP2LTA		52PP2L3A 52PP2L9A		
	120 V AC 1 3/4" (44.5 mm) mushroom head	red	1NO - 1NC	52PP2MRA		52PP2M2A		1
		green amber	1NO - 1NC 1NO - 1NC	52PP2MSA 52PP2MTA		52PP2M3A 52PP2M9A		
	240 V AC 1 3/4" (44.5 mm) mushroom head	red	1NO - 1NC	52PP2NRA		52PP2N2A		1
		green amber	1NO - 1NC 1NO - 1NC	52PP2NSA 52PP2NTA		52PP2N3A 52PP2N9A		
	2 Position Push Pull, Maintained^④ Illuminated, Full Voltage^① 24 V AC/DC 1 3/4" (44.5 mm) mushroom head with 52AADN, 24 V 757 type lamp or option: B = 52AED*, 24 V Single LED ^③	less operating head red green amber	1NO - 1NC 1NO - 1NC 1NO - 1NC 1NO - 1NC	52PP2DZA 52PP2DRA 52PP2DSA —		— 52PP2D2A 52PP2D3A 52PP2D9A		1
	2 Position Push Pull, Maintained^④ Illuminated, Transformer^① 120 V AC 1 3/4" (44.5 mm) mushroom head with 52AABN, 6 V 755 type lamp or option: B = 52AEB*, 6 V Single LED ^③	less operating head red green amber	1NO - 1NC 1NO - 1NC 1NO - 1NC 1NO - 1NC	52PP2GZA 52PP2GRA 52PP2GSA 52PP2GTA		— 52PP2G2A 52PP2G3A 52PP2G9A		1
	240 V AC 1 3/4" (44.5 mm) mushroom head with 52AABN, 6 V 755 type lamp or option: B = 52AEB*, 6 V Single LED ^③	less operating head red green amber	1NO - 1NC 1NO - 1NC 1NO - 1NC 1NO - 1NC	52PP2HZA 52PP2HRA 52PP2HSA 52PP2HTA		— 52PP2H2A 52PP2H3A 52PP2H9A		1
	480 V AC 1 3/4" (44.5 mm) mushroom head with 52AABN, 6 V 755 type lamp or option: B = 52AEB*, 6 V Single LED ^③	less operating head red green amber	1NO - 1NC 1NO - 1NC 1NO - 1NC 1NO - 1NC	52PP2JZA 52PP2JRA 52PP2JSA 52PP2JTA		— 52PP2J2A 52PP2J3A 52PP2J9A		1
	600V AC 1 3/4" (44.5 mm) mushroom head with 52AABN, 6 V 755 type lamp or option: B = 52AEB*, 6 V Single LED ^③	less operating head red green amber	1NO - 1NC 1NO - 1NC 1NO - 1NC 1NO - 1NC	52PP2KZA 52PP2KRA 52PP2KSA 52PP2KTA		— 52PP2K2A 52PP2K3A 52PP2K9A		1

Color options^②: black
blue
grey

5
A
B

① LED option available. For single LED only, append **B** to the end of the ordernumber. Single LEDs available for all colors. LED color and lens color must match. LED option is not available on units sold "less operating head". Example: Single LED: 52PP2HRAB

② To order a color option, replace the 7th digit of the order number.

③ Replace asterisk (*) in LED part number with color option that matches lens. See replacement lamps on page 17-271, for complete catalog number.



④ EMERGENCY-STOP control devices according to IEC 60947-5-5 when provided with red operating head and 52BJK contact blocks.

Pushbutton Units and Indicator Lights

30 mm Heavy Duty, Watertight/Oiltight, Class 52

Push Pull Complete Units

Selection and ordering data

Version	Color of actuator	Contact blocks	Order no.	List Price	Order no.	List Price	Pack	
				\$		\$		Unit
3 Position push-pull illuminated  	3 Position Push Pull, Momentary Illuminated, Integrated LED Module							
	24 V AC/DC 1 3/4" (44.5 mm) mushroom head	red green amber	1NO - 1NC 1NO - 1NC 1NO - 1NC	52PP3LRU 52PP3LSU 52PP3LTU		52PP3L2U 52PP3L3U 52PP3L9U	1	
	120 V AC 1 3/4" (44.5 mm) mushroom head	red green amber	1NO - 1NC 1NO - 1NC 1NO - 1NC	52PP3MRU 52PP3MSU 52PP3MTU		52PP3M2U 52PP3M3U 52PP3M9U	1	
	240 V AC 1 3/4" (44.5 mm) mushroom head	red green amber	1NO - 1NC 1NO - 1NC 1NO - 1NC	52PP3NRU 52PP3NSU 52PP3NTU		52PP3N2U 52PP3N3U 52PP3N9U	1	
	3 Position Push Pull, Momentary Illuminated, Full Voltage^① (Pull to start, push to stop) ^②							
	24 V AC/DC 1 3/4" (44.5 mm) mushroom head with 52AADN, 24 V 757 type lamp or option: B = 52AED*, 24 V Single LED ^④	less operating head red green amber	1NO - 1NC 1NO - 1NC 1NO - 1NC 1NO - 1NC	52PP3DZU 52PP3DRU 52PP3DSU 52PP3DTU		52PP3D2U 52PP3D3U 52PP3D9U	1	
	3 Position Push Pull, Momentary Illuminated, Transformer^① (Pull to start, push to stop) ^②							
	120 V AC 1 3/4" (44.5 mm) mushroom head with 52AABN, 6 V 755 type lamp or option: B = 52AEB*, 6 V Single LED ^④	less operating head red green amber	1NO - 1NC 1NO - 1NC 1NO - 1NC 1NO - 1NC	52PP3GZU 52PP3GRU 52PP3GSU 52PP3GTU		52PP3G2U 52PP3G3U 52PP3G9U	1	
	240 V AC 1 3/4" (44.5 mm) mushroom head with 52AABN, 6 V 755 type lamp or option: B = 52AEB*, 6 V Single LED ^④	less operating head red green amber	1NO - 1NC 1NO - 1NC 1NO - 1NC 1NO - 1NC	52PP3HZU 52PP3HRU 52PP3HSU 52PP3HTU		52PP3H2U 52PP3H3U 52PP3H9U	1	
	480 V AC 1 3/4" (44.5 mm) mushroom head with 52AABN, 6 V 755 type lamp or option: B = 52AEB*, 6 V Single LED ^④	less operating head red green amber	1NO - 1NC 1NO - 1NC 1NO - 1NC 1NO - 1NC	52PP3JZU 52PP3JRU 52PP3JSU 52PP3JTU		52PP3J2U 52PP3J3U 52PP3J9U	1	
	600 V AC 1 3/4" (44.5 mm) mushroom head with 52AABN, 6 V 755 type lamp or option: B = 52AEB*, 6 V Single LED ^④	less operating head red green amber	1NO - 1NC 1NO - 1NC 1NO - 1NC 1NO - 1NC	52PP3KZU 52PP3KRU 52PP3KSU 52PP3KTU		52PP3K2U 52PP3K3U 52PP3K9U	1	

Color options^③: blue
clear
white

5
A
B

Pilot Devices

17
CONTROL PRODUCTS

^① LED option available. For single LED only, append **B** to the end of the order number. Single LEDs available for all colors. LED color and lens color must match. LED option is not available on units sold "less operating head".
Example: Single LED: 52PP3G2UB

^② Blocks cannot be interchanged (start-stop circuit).

^③ To order a color option, replace the 7th digit of the order number.



^④ Replace asterisk (*) in LED part number with color option that matches lens. See replacement lamps on page 17-271, for complete catalog number.

Pushbutton Units and Indicator Lights

30 mm Heavy Duty, Watertight/Oiltight, Class 52

Push Pull Complete Units

Selection and ordering data

Version	Color of actuator	Contact blocks	Order no.	List Price	Order no.	List Price	Pack
				\$		\$	
3 Position push-pull illuminated  	3 Position Push Pull, Push Maintained, Pull Momentary Illuminated, Integrated LED Module (Pull to start, push to stop) ^②						
	24 V AC/DC 1 3/4" (44.5 mm) mushroom head	red green amber	1NO - 1NC 1NO - 1NC 1NO - 1NC	52PP7LRU 52PP7LSU 52PP7LTU		52PP7L2U 52PP7L3U 52PP7L9U	1
	120 V AC 1 3/4" (44.5 mm) mushroom head	red green amber	1NO - 1NC 1NO - 1NC 1NO - 1NC	52PP7MRU 52PP7MSU 52PP7MTU		52PP7M2U 52PP7M3U 52PP7M9U	1
	240 V AC 1 3/4" (44.5 mm) mushroom head	red green amber	1NO - 1NC 1NO - 1NC 1NO - 1NC	52PP7NRU 52PP7NSU 52PP7NTU		52PP7N2U 52PP7N3U 52PP7N9U	1
	3 Position Push Pull, Momentary Push Maintained, Pull Momentary Illuminated, Full Voltage^① (Pull to start, push to stop) ^②						
	24 V AC/DC 1 3/4" (44.5 mm) mushroom head with 52AADN, 24 V 757 type lamp or option: B = 52AED*, 24 V Single LED ^④	less operating head red green amber	1NO - 1NC 1NO - 1NC 1NO - 1NC 1NO - 1NC	52PP7DZU 52PP7DRU 52PP7DSU 52PP7DTU		52PP7D2U 52PP7D3U 52PP7D9U	1
	3 Position Push Pull, Momentary Push Maintained, Pull Momentary Illuminated, Transformer^① (Pull to start, push to stop) ^②						
	120 V AC 1 3/4" (44.5 mm) mushroom head with 52AABN, 6 V 755 type lamp or option: B = 52AEB*, 6 V Single LED ^④	less operating head red green amber	1NO - 1NC 1NO - 1NC 1NO - 1NC 1NO - 1NC	52PP7GZU 52PP7GRU 52PP7GSU 52PP7GTU		52PP7G2U 52PP7G3U 52PP7G9U	1
	240 V AC 1 3/4" (44.5 mm) mushroom head with 52AABN, 6 V 755 type lamp or option: B = 52AEB*, 6 V Single LED ^④	less operating head red green amber	1NO - 1NC 1NO - 1NC 1NO - 1NC 1NO - 1NC	52PP7HZU 52PP7HRU 52PP7HSU 52PP7HTU		52PP7H2U 52PP7H3U 52PP7H9U	1
	480 V AC 1 3/4" (44.5 mm) mushroom head with 52AABN, 6 V 755 type lamp or option: B = 52AEB*, 6 V Single LED ^④	less operating head red green amber	1NO - 1NC 1NO - 1NC 1NO - 1NC 1NO - 1NC	52PP7JZU 52PP7JRU 52PP7JSU 52PP7JTU		52PP7J2U 52PP7J3U 52PP7J9U	1
	600V AC 1 3/4" (44.5 mm) mushroom head with 52AABN, 6 V 755 type lamp or option: B = 52AEB*, 6 V Single LED ^④	less operating head red green amber	1NO - 1NC 1NO - 1NC 1NO - 1NC 1NO - 1NC	52PP7KZU 52PP7KRU 52PP7KSU 52PP7KTU		52PP7K2U 52PP7K3U 52PP7K9U	1

Color options^③: blue
clear
white

5
A
B

① LED option available. For single LED only, append **B** to the end of the order number. Single LEDs available for all colors. LED color and lens color must match. LED option is not available on units sold "less operating head".
Example: Single LED: 52PP7JTUB

② Blocks cannot be interchanged (start-stop circuit).

③ To order a color option, replace the 7th digit of the order number.



④ Replace asterisk (*) in LED part number with color option that matches lens. See replacement lamps on page 17-271, for complete catalog number.

Pushbutton Units and Indicator Lights

30 mm Heavy Duty, Watertight/Oiltight, Class 52

Twist-to-release complete units

Selection and ordering data

Version	Color of actuator	Contact blocks	Order no.	List Price	Pack	
				\$	Unit	
2 Position twist-to-release non-illuminated 	2 Position Twist-To-Release, Maintained® Non-Illuminated					
	1 3/4" (44.5 mm) mushroom head	less operating head	1NO - 1NC	52PR8WZA	1	
		red	1NO - 1NC	52PR8W2A		
		green	1NO - 1NC	52PR8W3A		
		yellow	1NO - 1NC	52PR8W4A		
2 Position twist-to-release illuminated 	2 Position Twist-To-Release, Maintained® Illuminated, Integrated LED Module					
	24 V AC/DC 1 3/4" (44.5 mm) mushroom head	red	1NO - 1NC	52PR8LRA	1	
		green	1NO - 1NC	52PR8LSA		
		amber	1NO - 1NC	52PR8LTA		
	120 V AC 1 3/4" (44.5 mm) mushroom head	red	1NO - 1NC	52PR8MRA	1	
		green	1NO - 1NC	52PR8MSA		
		amber	1NO - 1NC	52PR8MTA		
	240 V AC 1 3/4" (44.5 mm) mushroom head	red	1NO - 1NC	52PR8NRA	1	
		green	1NO - 1NC	52PR8NSA		
		amber	1NO - 1NC	52PR8NTA		
	2 Position Twist-To-Release, Maintained® Illuminated, Full Voltage^①					
	24 V AC/DC 1 3/4" (44.5 mm) mushroom head with 52AADN, 24V 757 type lamp or option: B = 52AED*, 24V Single LED ^②	less operating head	1NO - 1NC	52PR8DZA	1	
		red	1NO - 1NC	52PR8DRA		
		green	1NO - 1NC	52PR8DSA		
		amber	1NO - 1NC	52PR8DTA		
	2 Position Twist-To-Release, Maintained® Illuminated, Transformer^①					
	120 V AC 1 3/4" (44.5 mm) mushroom head with 52AABN, 6 V 755 type lamp or option: B = 52AEB*, 6 V Single LED ^②	less operating head	1NO - 1NC	52PR8GZA	1	
		red	1NO - 1NC	52PR8GRA		
		green	1NO - 1NC	52PR8GSA		
		amber	1NO - 1NC	52PR8GTA		
240 V AC 1 3/4" (44.5 mm) mushroom head with 52AABN, 6 V 755 type lamp or option: B = 52AEB*, 6 V Single LED ^②	less operating head	1NO - 1NC	52PR8HZA	1		
	red	1NO - 1NC	52PR8HRA			
	green	1NO - 1NC	52PR8HSA			
	amber	1NO - 1NC	52PR8HTA			
480 V AC 1 3/4" (44.5 mm) mushroom head with 52AABN, 6 V 755 type lamp or option: B = 52AEB*, 6 V Single LED ^②	less operating head	1NO - 1NC	52PR8JZA	1		
	red	1NO - 1NC	52PR8JRA			
	green	1NO - 1NC	52PR8JSA			
	amber	1NO - 1NC	52PR8JTA			
600V AC 1 3/4" (44.5 mm) mushroom head with 52AABN, 6 V 755 type lamp or option: B = 52AEB*, 6 V Single LED ^②	less operating head	1NO - 1NC	52PR8KZA	1		
	red	1NO - 1NC	52PR8KRA			
	green	1NO - 1NC	52PR8KSA			
	amber	1NO - 1NC	52PR8KTA			

^① LED option available. For single LED only, append **B** to the end of the order number. Single LEDs available for all colors. LED color and lens color must match. LED option is not available on units sold "less operating head".

Example: Single LED: 52PR8GSAB

^② Replace asterisk (*) in LED part number with color option that matches lens. See replacement lamps on page 17-271, for complete catalog number.



^③ EMERGENCY-STOP control devices according to IEC 60947-5-5 when provided with red operating head and 52BJK contact blocks.

Pushbutton Units and Indicator Lights

30 mm Heavy Duty, Watertight/Oiltight, Class 52

Selector switch complete units

Selection and ordering data

	Version	Lever type	Contact blocks	Cam ^①	Order no.	List Price	Pack
						\$	unit
Selector Switches with 2 switching positions							
 <p>Short lever assembled selector switch</p>	Maintained operation	Short lever, non-Illuminated	1NO	A	52SA2AABK1		1
		Short lever, non-Illuminated	1NC	A	52SA2AABJ1		
		Short lever, non-Illuminated	1NO + 1NC	A	52SA2AABA1		
		Long lever, non-Illuminated	1NO	A	52SB2AABK1		
		Long lever, non-Illuminated	1NC	A	52SB2AABJ1		
		Long lever, non-Illuminated	1NO + NC	A	52SB2AABA1		
	Spring return from right operation	Short lever, non-Illuminated	1NO	A	52SA2ACBK1		1
		Short lever, non-Illuminated	1NC	A	52SA2ACBJ1		
		Short lever, non-Illuminated	1NO + 1NC	A	52SA2ACBA1		
		Long lever, non-Illuminated	1NO	A	52SB2ACBK1		
Long lever, non-Illuminated		1NC	A	52SB2ACBJ1			
Long lever, non-Illuminated		1NO + 1NC	A	52SB2ACBA1			
Selector Switches with 3 switching positions							
 <p>Long lever assembled selector switch</p>	Maintained operation	Short lever, non-Illuminated	1NO + 1NC	C	52SA2CABA1		1
		Short lever, non-Illuminated	2NC + 1NO	G	52SA2GABJ2K1		
		Short lever, non-Illuminated	2NO + 2NC	C	52SA2CABA2		
		Long lever, non-Illuminated	1NO + 1NC	C	52SB2CABA1		
		Long lever, non-Illuminated	2NC + 1NO	G	52SB2GABJ2K1		
		Long lever, non-Illuminated	2NO + 2NC	C	52SB2CABA2		
	Spring return from right	Short lever, non-Illuminated	1NO + 1NC	C	52SA2CCBA1		1
		Short lever, non-Illuminated	2NC + 1NO	G	52SA2GCBJ2K1		
		Short lever, non-Illuminated	2NO + 2NC	C	52SA2CCBA2		
		Long lever, non-Illuminated	1NO + 1NC	C	52SB2CCBA1		
Long lever, non-Illuminated		2NC + 1NO	G	52SB2GCBJ2K1			
Long lever, non-Illuminated		2NO + 2NC	C	52SB2CCBA2			
Spring return from left	Short lever, non-Illuminated	1NO + 1NC	C	52SA2CBBA1		1	
	Short lever, non-Illuminated	2NC + 1NO	G	52SA2GBBJ2K1			
	Short lever, non-Illuminated	2NO + 2NC	C	52SA2CBBA2			
	Long lever, non-Illuminated	1NO + 1NC	C	52SB2CBBA1			
	Long lever, non-Illuminated	2NC + 1NO	G	52SB2GBBJ2K1			
	Long lever, non-Illuminated	2NO + 2NC	C	52SB2CBBA2			
Spring return from right & left operation	Short lever, non-Illuminated	1NO + 1NC	C	52SA2CDBA1		1	
	Short lever, non-Illuminated	2NC + 1NO	G	52SA2GDBJ2K1			
	Short lever, non-Illuminated	2NO + 2NC	C	52SA2CDBA2			
	Long lever, non-Illuminated	1NO + 1NC	C	52SB2CDBA1			
	Long lever, non-Illuminated	2NC + 1NO	G	52SB2GDBJ2K1			
	Long lever, non-Illuminated	2NO + 2NC	C	52SB2CDBA2			

① For contact operation, see cam selection table on page 17-266.

Pushbutton Units and Indicator Lights

30 mm Heavy Duty, Watertight/Oiltight, Class 52

Keyed selector switch complete units

Selection and ordering data

Version	Lever type	Contact blocks	Cam ^①	Order no.	List Price	Pack
					\$	unit
Key-operated selector switches, 2 switching positions						
Assembled keyed selector switch 	Maintained operation	Key removable in left positions	1NO	A	52SC6AFK1	1
		Key removable in left positions	1NC	A	52SC6AFJ1	
		Key removable in left positions	1NO + 1NC	A	52SC6AFA1	
	Spring return from right operation	Key removable in all positions	1NO	A	52SC6AEK1	1
			1NC	A	52SC6AEJ1	
			1NO + 1NC	A	52SC6AEA1	
	Spring return from right operation	Key removable in left positions	1NO	A	52SC6AXK1	1
			1NC	A	52SC6AXJ1	
			1NO + 1NC	A	52SC6AXA1	
Key-operated selector switches, 3 switching positions						
Maintained operation	Key removable in all positions	1NC + 1NO	C	52SC6CEA1	1	
		2NC + 1NO	G	52SC6GEJ2K1		
		2NO + 2NC	C	52SC6CEA2		
Spring return from right operation	Key removable in all positions	1NO + 1NC	C	52SC6CZA1	1	
		2NC + 1NO	G	52SC6GZJ2K1		
		2NO + 2NC	C	52SC6CZA2		
Spring return from left operation	Key removable in all positions	1NO + 1NC	C	52SC6CUA1	1	
		2NC + 1NO	G	52SC6GUJ2K1		
		2NO + 2NC	C	52SC6CUA2		
Spring return from right & left operation	Key removable in all positions	1NO + 1NC	C	52SC6CVA1	1	
		2NC + 1NO	G	52SC6GVJ2K1		
		2NO + 2NC	C	52SC6CVA2		

Pilot Devices

17 CONTROL PRODUCTS

① For contact operation, see cam selection table on page 17-266.

Pushbutton Units and Indicator Lights

30 mm Heavy Duty, Watertight/Oiltight, Class 52

Indicator Light Operators

Selection and ordering data

Version	Color of actuator	Contact blocks	Order no.	List Price	Order no.	List Price	Pack
			Operators with Incandescent lamp	\$	Operators with LED lamp^⑤	\$	Unit
Pilot light	Indicator light with plastic lens - Resistor type AC^{①②}						
	240 V, 52PC4N with 52AAENC1, 120 V 120MB type lamp or 240 V, 52PE4N with 52AEE* Single-LED ^⑤	red green amber less lens	52PC4N2 52PC4N3 52PC4N9 52PC4NN		52PE4N2 52PE4N3 52PE4N9 —		1
	Push to test indicator light with plastic lens - Resistor type AC/DC^④						
	120V with 24V 757 type lamp, or 24V LED	red	1NC + 1NO	52PA6M2A		52PE6M2A	1
		green	1NC + 1NO	52PA6M3A		52PE6M3A	
	240V with 24V 757 type lamp, or 24V LED	red	1NC + 1NO	52PA6N2A		52PE6N2A	1
green		1NC + 1NO	52PA6N3A		52PE6N3A		
	amber	1NC + 1NO	52PA6N9A		52PE6N9A		
	less lens	1NC + 1NO	52PA6NNA		—		

Color code table^②: blue
clear
white

5
A
B

5
A
B

Pilot Devices

Wiring Diagrams

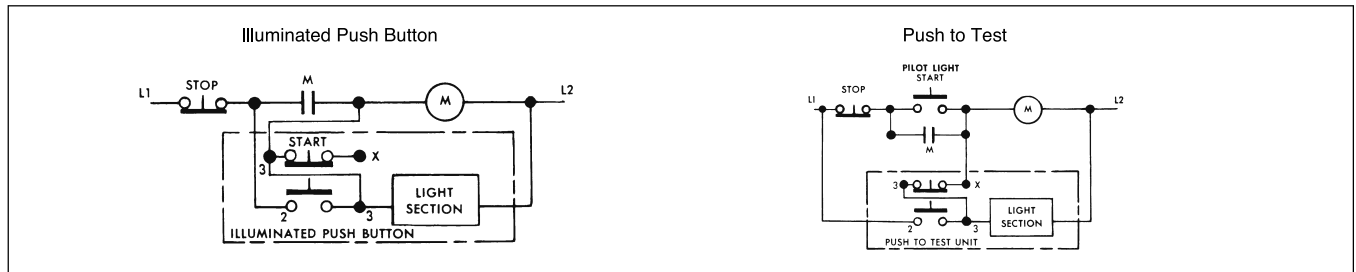

- ① All illuminated devices come with std. Touch-safe shield per UL standards except where noted (Resistor Type Pilot Devices are not touch safe).
- ② For factory installed glass lens, replace the 5th character with "5".

- ③ LED color and lens color must match. LED option is not available on units sold "less operating head". Resistor Type Pilot Devices with Standard Incandescent lamps are provided with different value resistors than pilot devices ordered using the LED option. LED lamps can only be installed in pilot lights that are ordered from the factory utilizing the LED option suffix.

- ④ For factory installed lens guard, add suffix "V".
- ⑤ Replace asterisk (*) in LED part number with color option that matches lens. See replacement lamps on page 17-271, for complete catalog number.

Pushbutton Units and Indicator Lights

30 mm Heavy Duty, Watertight/Oiltight, Class 52

Pushbutton Operators Only

Selection and ordering data

Version	Color of actuator	Contact blocks	Order no.	Plastic Lens ^④	List Price	Pack
					\$	Unit
Push to test 	Illuminated pushbutton / Push to test Integrated LED Module					
	24V AC/DC	red	1NO - 1NC	52PT6L2A		1
		green	1NO - 1NC	52PT6L3A		
		amber	1NO - 1NC	52PT6L9A		
	120V AC	red	1NO - 1NC	52PT6M2A		1
		green	1NO - 1NC	52PT6M3A		
		amber	1NO - 1NC	52PT6M9A		
	240V AC	red	1NO - 1NC	52PT6N2A		1
		green	1NO - 1NC	52PT6N3A		
		amber	1NO - 1NC	52PT6N9A		
	Illuminated pushbutton / Push to test Full Voltage^①					
	24V AC/DC with 52AADN, 24V 757 type lamp or option: B = 52AED*, 24V Single LED3)	less operating head	1NO - 1NC	52PT6DNA		1
		red	1NO - 1NC	52PT6D2A		
		green	1NO - 1NC	52PT6D3A		
		amber	1NO - 1NC	52PT6D9A		
	Illuminated pushbutton / Push to test Transformer^①					
	120V AC with 52AABN, 6 V 755 type lamp or option: B = 52AEB*, 6 V Single LED3)	less operating head	1NO - 1NC	52PT6GNA		1
		red	1NO - 1NC	52PT6G2A		
	green	1NO - 1NC	52PT6G3A			
	amber	1NO - 1NC	52PT6G9A			
240V AC with 52AABN, 6 V 755 type lamp or option: B = 52AEB*, 6 V Single LED3)	less operating head	1NO - 1NC	52PT6HNA		1	
	red	1NO - 1NC	52PT6H2A			
	green	1NO - 1NC	52PT6H3A			
	amber	1NO - 1NC	52PT6H9A			
480V AC with 52AABN, 6 V 755 type lamp or option: B = 52AEB*, 6 V Single LED3)	less operating head	1NO - 1NC	52PT6JNA		1	
	red	1NO - 1NC	52PT6J2A			
	green	1NO - 1NC	52PT6J3A			
	amber	1NO - 1NC	52PT6J9A			
600V AC with 52AABN, 6 V 755 type lamp or option: B = 52AEB*, 6 V Single LED3)	less operating head	1NO - 1NC	52PT6KNA		1	
	red	1NO - 1NC	52PT6K2A			
	green	1NO - 1NC	52PT6K3A			
	amber	1NO - 1NC	52PT6K9A			

Color code table^②:
blue
clear
white

5
A
B

Wiring Diagrams

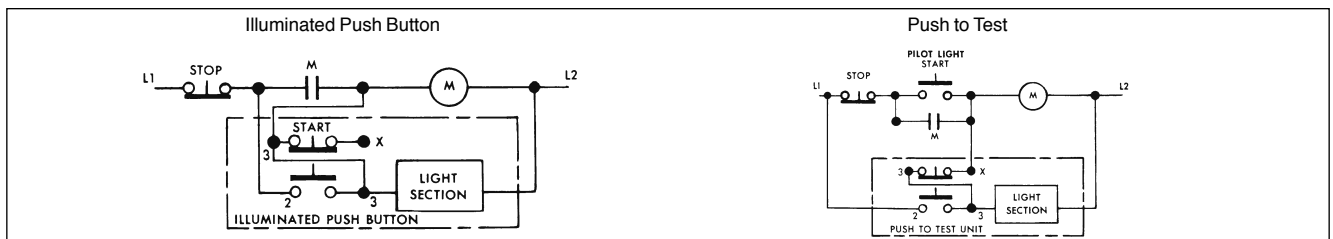

① **LED option available.** For single LED only, append **B** to the end of the order number. Single LEDs available for all colors. LED color and lens color must match. LED option is not available on units sold "less operating head" Example: Single LED: 52PT6D3AB (Cluster LED option is not available for PTT Pilot Lights.)

② To order a color option, replace the 7th digit of the order number.

③ Replace asterisk (*) in LED part number with color option that matches lens. See replacement lamps on page 17-271, for complete catalog number.

④ For factory installed lens guard, add suffix "V".

Pushbutton Units and Indicator Lights

30 mm Heavy Duty, Watertight/Oiltight, Class 52

Pushbutton and push-pull operators

Selection and ordering data

Version	Color of actuator	Order no.	List Price	Pack	
			\$	Unit	
Pushbutton with flush cap Flush pushbutton operator 	black	52PA8A1		1	
	red	52PA8A2			
	green	52PA8A3			
	yellow	52PA8A4			
	blue	52PA8A5			
	gray	52PA8A6			
	orange	52PA8A8			
	less cap	52PA8			
	kit with all colors	52PA8AN			
	Pushbutton with extended cap	black	52PA8B1		1
		red	52PA8B2		
		green	52PA8B3		
		yellow	52PA8B4		
		blue	52PA8B5		
gray		52PA8B6			
orange		52PA8B8			
less cap		52PA8			
kit with all colors		52PA8BN			
Pushbutton with mushroom cap 1 5/8" (41.3mm), set screw		black	52PB9D1		1
	red	52PB9D2			
	green	52PB9D3			
	yellow	52PB9D4			
	blue	52PB9D5			
	gray	52PB9D6			
	orange	52PB9D8			
	less cap	52PB9			
	kit with all colors	52PB9DN			
	2 1/2" (63.5mm), set screw	black	52PB9E1		1
red		52PB9E2			
green		52PB9E3			
yellow		52PB9E4			
blue		52PB9E5			
gray		52PB9E6			
orange		52PB9E8			
less cap		52PB9			
less cap with lens kit		52PB9EN			
2 position push pull maintained, non illuminated Metal Mushroom Head, 1 3/4" (44.5 mm) threaded on		red	52PP2A2		1
	green	52PP2A3			
	chrome	52PP2AC			
	Small Plastic Mushroom Head, 1 3/4" (44.5 mm) threaded on	black	52PP2W1		1
		red	52PP2W2		
		green	52PP2W3		
	Large Plastic Mushroom Head, 2 1/2" (63.5 mm) threaded on	black	52PP2V1		1
		red	52PP2V2		
		green	52PP2V3		
2 position twist to release, maintained, non-illuminated Small Plastic Mushroom Head, 1 3/4" (44.5 mm) threaded on	red	52PR8W2		1	
	green	52PR8W3			
	yellow	52PR8W4			

Pushbutton Units and Indicator Lights

30 mm Heavy Duty, Watertight/Oiltight, Class 52

Selector Switch Operators

Selection and ordering data

Version	Lever type	Color of lever insert	Input Voltage	Cam Code ^②	Order no.	List Price \$	Pack unit
Selector Switches with 2 switching positions							
Maintained operation	Non-Illuminated, short lever	White		A	52SA2AAB		1
	Non-Illuminated, long lever	White		A	52SB2AAB		
	Illuminated, short lever ^① with full voltage 24V, 755 type lamp		24V	A	52SA7ADN		1
			24V	A	52SA7ALN		1
			120V	A	52SA7AGN		
			240V	A	52SA7AHN		
Spring return from right operation	Non-Illuminated, short lever	White		A	52SA2ACB		1
	Non-Illuminated, long lever	White		A	52SB2ACB		
Selector Switches with 3 switching positions							
Maintained operation	Non-Illuminated, short lever	White		B	52SA2BAB		1
	Non-Illuminated, long lever	White		B	52SB2BAB		
	Non-Illuminated, short lever	White		C ^③	52SA2CAB		
	Non-Illuminated, long lever	White		C ^③	52SB2CAB		
	Non-Illuminated, short lever	White		D	52SA2DAB		
	Non-Illuminated, long lever	White		D	52SB2DAB		
	Non-Illuminated, short lever	White		E	52SA2EAB		
	Non-Illuminated, long lever	White		E	52SB2EAB		
	Non-Illuminated, short lever	White		G	52SA2GAB		
Non-Illuminated, long lever	White		G	52SB2GAB			
	Illuminated, short lever ^① with full voltage 24V, 757 type lamp		24V 24V	B C ^③	52SA7BDN 52SA7CDN		1
			24V 24V	B C	52SA7BLN 52SA7CLN		1
			120V	B	52SA7BGN		
			120V	C ^③	52SA7CGN		
			240V 240V	B C ^③	52SA7BHN 52SA7CHN		
Spring return from right operation	Non-Illuminated, short lever	White		B	52SA2BCB		1
	Non-Illuminated, long lever	White		B	52SB2BCB		
	Non-Illuminated, short lever	White		C ^③	52SA2CCB		
	Non-Illuminated, long lever	White		C ^③	52SB2CCB		
	Non-Illuminated, short lever	White		D	52SA2DCB		
	Non-Illuminated, long lever	White		D	52SB2DCB		
	Non-Illuminated, short lever	White		E	52SA2ECB		
	Non-Illuminated, long lever	White		E	52SB2ECB		
	Non-Illuminated, short lever	White		G	52SA2GCB		
	Non-Illuminated, long lever	White		G	52SB2GCB		
	Spring return from left operation	Non-Illuminated, short lever	White		B	52SA2BBB	
Non-Illuminated, long lever		White		B	52SB2BBB		
Non-Illuminated, short lever		White		C ^③	52SA2CBB		
Non-Illuminated, long lever		White		C ^③	52SB2CBB		
Non-Illuminated, short lever		White		D	52SA2DBB		
Non-Illuminated, long lever		White		D	52SB2DBB		
Non-Illuminated, short lever		White		E	52SA2EBB		
Non-Illuminated, long lever		White		E	52SB2EBB		
Non-Illuminated, short lever		White		G	52SA2GBB		
Non-Illuminated, long lever		White		G	52SB2GBB		
Spring return from left and right operation		Non-Illuminated, short lever	White		B	52SA2BDB	
	Non-Illuminated, long lever	White		B	52SB2BDB		
	Non-Illuminated, short lever	White		C ^③	52SA2CDB		
	Non-Illuminated, long lever	White		C ^③	52SB2CDB		
	Non-Illuminated, short lever	White		D	52SA2ddb		
	Non-Illuminated, long lever	White		D	52SB2ddb		
	Non-Illuminated, short lever	White		E	52SA2EDB		
	Non-Illuminated, long lever	White		E	52SB2EDB		
	Non-Illuminated, short lever	White		G	52SA2GDB		
	Non-Illuminated, long lever	White		G	52SB2GDB		
	Selector Switches with 4 switching positions						
Maintained operation	Non-Illuminated, short lever	White		H	52SA2HAB		1
	Non-Illuminated, long lever	White		H	52SB2HAB		

^① Illuminated selector switches are provided without lenses. Lens kit must be ordered separately on page 17-269.

^② For contact operation, see cam selection chart on page 17-266.

^③ The C cam is limited to 4 contact blocks, 1 or 2 pole.

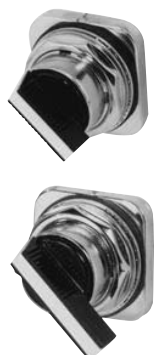

Pushbutton Units and Indicator Lights

30 mm Heavy Duty, Watertight/Oiltight, Class 52

Selector Switch Operators

Selection and ordering data

Version	Button	Color of lever insert	Cam Code ①	Order no.	List Price	Pack	
					\$	unit	
Selector Pushbutton Operators - 2 Position							
	NEMA 12/13 only	Flush	Black	P	52SA3P1	1	
		Flush	Black	Q	52SA3Q1		
		Flush	Black	R	52SA3R1		
		Flush	Red	P	52SA3P2	1	
		Flush	Red	Q	52SA3Q2		
		Flush	Red	R	52SA3R2		
		Extended 1/2"	Black	P	52SA4P1	1	
		Extended 1/2"	Black	Q	52SA4Q1		
		Extended 1/2"	Black	R	52SA4R1		
		Extended 1/2"	Red	P	52SA4P2	1	
		Extended 1/2"	Red	Q	52SA4Q2		
		Extended 1/2"	Red	R	52SA4R2		
	Selector Pushbutton Operators - 3 Position						
	NEMA 12/13 only	Flush	Black	S	52SA3S1	1	
		Flush	Red	S	52SA3S2		
Extended 1/2"		Black	S	52SA4S1	1		
Extended 1/2"		Red	S	52SA4S2			

Pilot Devices

17 CONTROL PRODUCTS

① For contact operation, see cam selection chart on page 17-266.

Pushbutton Units and Indicator Lights

30 mm Heavy Duty, Watertight/Oiltight, Class 52

Keyed selector switch operators

Selection and ordering data



Version	Key removal position	Lock No.	Cam Code ①	Order no.	List Price \$	Pack unit
Key-operated selector Switches with 2 switching positions						
Maintained operation	Both	501CH	A	52SC6AE		1
	Left	501CH	A	52SC6AF		
Spring return from right operation	Center	501CH	A	52SC6AX		1
Key-operated selector Switches with 3 switching positions						
Maintained operation	All	501CH	B	52SC6BE		1
			C ②	52SC6CE		
			D	52SC6DE		
	Left	501CH	E	52SC6EE		1
			G	52SC6GE		
			B	52SC6BF		
	Right	501CH	C ②	52SC6CF		1
			D	52SC6DF		
			E	52SC6EF		
	Center	501CH	G	52SC6GF		1
			B	52SC6BG		
			C ②	52SC6CG		
	Left and right	501CH	D	52SC6DG		1
			E	52SC6EG		
			G	52SC6GG		
Left and center	501CH	B	52SC6BH		1	
		C ②	52SC6CH			
		D	52SC6DH			
Right and center	501CH	E	52SC6EH		1	
		G	52SC6GH			
		B	52SC6BJ			
Spring return from right operation	Center	501CH	C ②	52SC6CJ		1
			D	52SC6DJ		
			E	52SC6EJ		
Left and center	501CH	501CH	G	52SC6GJ		1
			B	52SC6BK		
			C ②	52SC6CK		
Right and center	501CH	501CH	D	52SC6DK		1
			E	52SC6EK		
			G	52SC6GK		
Spring return from left operation	Center	501CH	B	52SC6BM		1
			C ②	52SC6CM		
			D	52SC6DM		
Left and center	501CH	501CH	E	52SC6EM		1
			G	52SC6GM		
			B	52SC6BU		
Spring return from left and right operation	Center	501CH	C ②	52SC6CU		1
			D	52SC6DU		
			E	52SC6EU		
Right	501CH	501CH	G	52SC6GU		1
			B	52SC6BZ		
			C ②	52SC6CZ		
Center and right	501CH	501CH	D	52SC6DZ		1
			E	52SC6EZ		
			G	52SC6GZ		
Spring return from left and right operation	Center	501CH	B	52SC6BT		1
			C ②	52SC6CT		
			D	52SC6DT		
Right	501CH	501CH	E	52SC6ET		1
			G	52SC6GT		
			B	52SC6BW		
Center and right	501CH	501CH	C ②	52SC6CW		1
			D	52SC6DW		
			E	52SC6EW		
Spring return from left and right operation	Center	501CH	G	52SC6GW		1
			B	52SC6BY		
			C ②	52SC6CY		
Spring return from left and right operation	Center	501CH	D	52SC6DY		1
			E	52SC6EY		
			G	52SC6GY		

Lock types keyed different from standard - up to 25 different keys

To order special locks for keyed selector switches, replace 5th digit with a 5 and append corresponding 'X' suffix to part number. (Same list price as standard key)

Ordering example
52SC6AEX298

#50CH
#549CH

#548CH
#547CH
#506CH

5
X298
X299
X300
X301
X302

① For contact operation, see cam selection chart on page 17-266.





② C cam limited to 4 single or double pole blocks on spring return operators

Pushbutton Units and Indicator Lights

30 mm Heavy Duty, Watertight/Oiltight, Class 52

Special Devices

Selection and ordering data

Version	Ohms / color	Order no.	List Price	Pack
			\$	Unit
 <p>Potentiometer operator 2 Watts, 500 V AC/DC (Type 12/3 only)</p>	50	52MA3B01		1
	150	52MA3B03		
	250	52MA3B04		
	500	52MA3B06		
	750	52MA3B07		
	1 K	52MA3B08		
	2.5 K	52MA3B10		
	5 K	52MA3B12		
	10 K	52MA3B14		
	15 K	52MA3B15		
	25 K	52MA3B16		
	50 K	52MA3B18		
	100 K	52MA3B20		
	150 K	52MA3B21		
	250 K	52MA3B22		
	500 K	52MA3B24		
1 M	52MA3B26			
1.5 M	52MA3B27			
2 M	52MA3B28			
5 M	52MA3B31			
 <p>2 Button maintained operator</p> <p>Button remains depressed when pushed</p>	black (flush) / red (flush)	52MA2A1A2		1
	black (flush) / red (extended)	52MA2A1B2		
	black (flush) / yellow (mushroom)	52MA2A1D4		
	green (flush) / red (flush)	52MA2A3A2		
	green (flush) / red (extended)	52MA2A3B2		
	green (flush) / red (mushroom)	52MA2A3D2		
	green (flush) / green (mushroom)	52MA2A3D3		
	less caps	52MA2		
 <p>Wobble stick 2.5" operator For use with 52BAJ (NC) contact block</p>	red	52ABW2 ^①		1
	green	52ABW3 ^①		
	grey	52ABW6 ^①		
 <p>Maintained toggle operator</p>		52ABT		1

① For use with 52BAJ (NC) contact block