

PP-H 6/ 1-L - Plug

3061664

<https://www.phoenixcontact.com/pc/products/3061664>

Please be informed that the data shown in this PDF document is generated from our online catalog. Please find the complete data in the user documentation. Our general terms of use for downloads are valid.



Plug, for self-assembly, nom. voltage: 1000 V, nominal current: 41 A, number of connections: 1, number of positions: 1, connection method: Push-in connection, 1 level, Rated cross section: 6 mm², cross section: 0.5 mm² - 10 mm², color: gray

Your advantages

- Large-surface labeling option
- The Push-in technology COMBI plugs for self-assembly provide solutions that users can implement themselves
- Tested for railway applications

Commercial data

Item number	3061664
Packing unit	50 pc
Minimum order quantity	50 pc
Product key	BE2244
Catalog page	Page 352 (C-1-2019)
GTIN	4046356650311
Weight per piece (including packing)	7.651 g
Weight per piece (excluding packing)	7.201 g
Customs tariff number	85366990
Country of origin	PL

PP-H 6/ 1-L - Plug

3061664

<https://www.phoenixcontact.com/pc/products/3061664>

Technical data

Product properties

Product type	Terminal plug
Number of positions	1
Pitch	8.2 mm
Area of application	Railway industry
	Machine building
	Plant engineering
Number of connections	1
Number of rows	1
Potentials	1

Insulation characteristics

Overvoltage category	III
Degree of pollution	3

Electrical properties

Rated surge voltage	8 kV
Maximum power dissipation for nominal condition	1.31 W

Connection data

Number of connections per level	1
Nominal cross section	6 mm ²

1 level

Stripping length	12 mm
Internal cylindrical gage	A5
Connection in acc. with standard	IEC 61984
Conductor cross section rigid	0.5 mm ² ... 10 mm ²
Cross section AWG	20 ... 8 (converted acc. to IEC)
Conductor cross section flexible	0.5 mm ² ... 6 mm ²
Conductor cross section, flexible [AWG]	20 ... 10 (converted acc. to IEC)
Conductor cross-section flexible (ferrule without plastic sleeve)	0.5 mm ² ... 6 mm ²
Flexible conductor cross section (ferrule with plastic sleeve)	0.5 mm ² ... 6 mm ²
Conductor cross-section flexible (2 conductors with the same cross-section, with TWIN ferrule and plastic sleeve)	0.5 mm ² ... 1.5 mm ²
2 conductors with the same cross section, flexible, with TWIN ferrule with plastic sleeve	0.5 mm ² ... 1.5 mm ²
Nominal current	41 A
Maximum load current	41 A (with 6 mm ² conductor cross section)
Nominal voltage	1000 V
Nominal cross section	6 mm ²

1 level Connection cross sections directly pluggable

PP-H 6/ 1-L - Plug

3061664

<https://www.phoenixcontact.com/pc/products/3061664>

Conductor cross section rigid	1 mm ² ... 10 mm ²
Conductor cross-section flexible (ferrule without plastic sleeve)	1 mm ² ... 6 mm ²
Flexible conductor cross section (ferrule with plastic sleeve)	1 mm ² ... 6 mm ²

Dimensions

Width	8.2 mm
Height	21 mm
Depth	49.3 mm
Pitch	8.2 mm

Material specifications

Color	gray
Flammability rating according to UL 94	V0
Insulating material group	I
Insulating material	PA
Static insulating material application in cold	-60 °C
Temperature index of insulation material (DIN EN 60216-1 (VDE 0304-21))	130 °C
Relative insulation material temperature index (Elec., UL 746 B)	130 °C
Fire protection for rail vehicles (DIN EN 45545-2) R22	HL 1 - HL 3
Fire protection for rail vehicles (DIN EN 45545-2) R23	HL 1 - HL 3
Fire protection for rail vehicles (DIN EN 45545-2) R24	HL 1 - HL 3
Fire protection for rail vehicles (DIN EN 45545-2) R26	HL 1 - HL 3
Calorimetric heat release NFPA 130 (ASTM E 1354)	28 MJ/kg
Surface flammability NFPA 130 (ASTM E 162)	passed
Specific optical density of smoke NFPA 130 (ASTM E 662)	passed
Smoke gas toxicity NFPA 130 (SMP 800C)	passed

Mechanical properties

Mechanical data

Open side panel	No
-----------------	----

Environmental and real-life conditions

Ambient conditions

Ambient temperature (operation)	-60 °C (max. operating temperature see derating curve)
Ambient temperature (storage/transport)	-25 °C ... 60 °C (for a short time, no longer than 24 h, -60°C to +70°C)
Ambient temperature (assembly)	-5 °C ... 70 °C
Ambient temperature (actuation)	-5 °C ... 70 °C
Permissible humidity (operation)	20 % ... 90 %
Permissible humidity (storage/transport)	30 % ... 70 %

Standards and regulations

Connection in acc. with standard	IEC 61984
----------------------------------	-----------

PP-H 6/ 1-L - Plug

3061664

<https://www.phoenixcontact.com/pc/products/3061664>



Mounting

Assembly instructions

Use of a parallel pressing tool is recommended for easy latching of the COMBI connector and coupling elements for self-assembly

PP-H 6/ 1-L - Plug

3061664

<https://www.phoenixcontact.com/pc/products/3061664>



Drawings

Schematic diagram

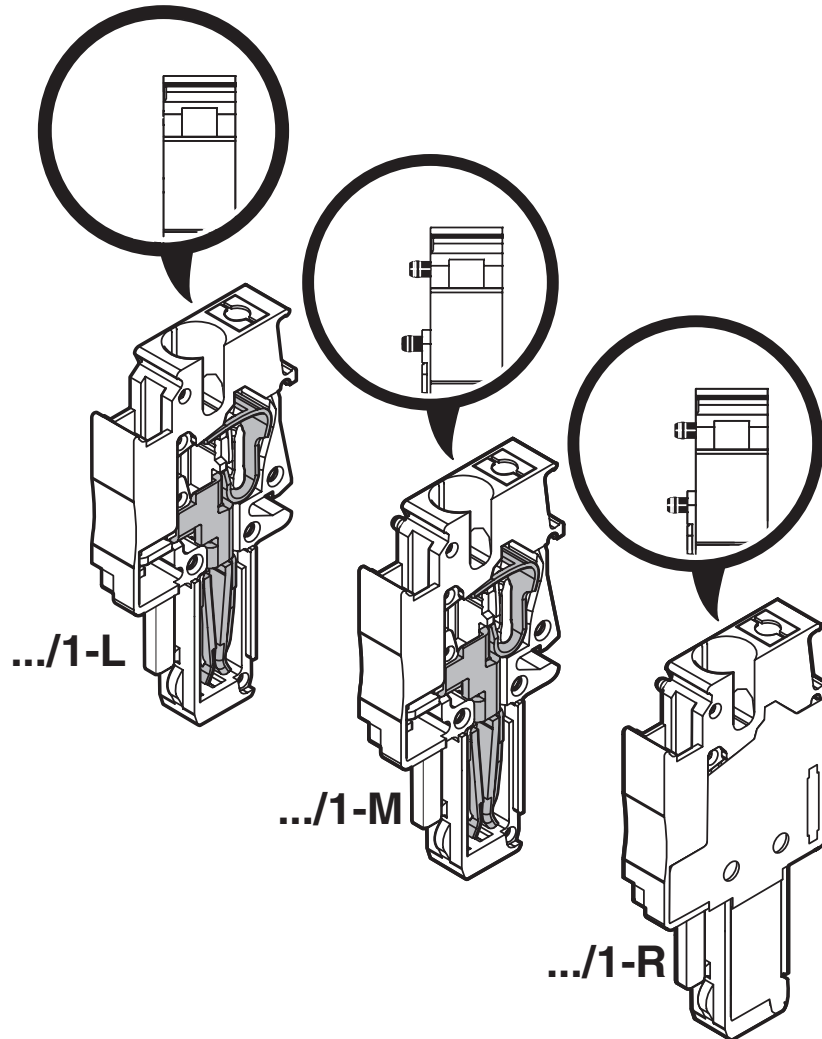

Diagram

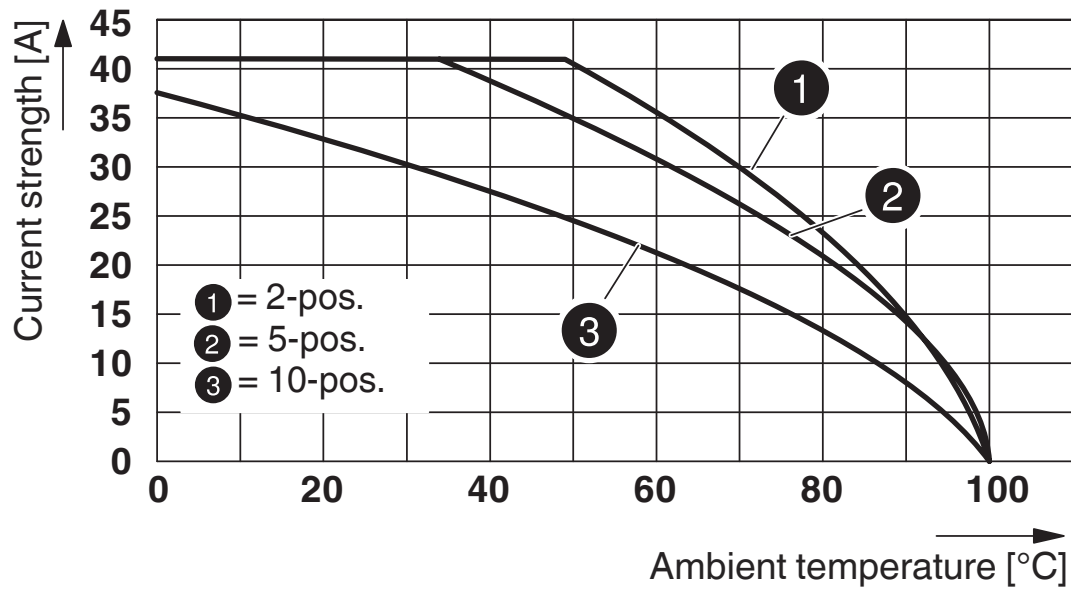

Circuit diagram



PP-H 6/ 1-L - Plug





3061664

<https://www.phoenixcontact.com/pc/products/3061664>

Approvals

To download certificates, visit the product detail page: <https://www.phoenixcontact.com/pc/products/3061664>

 CSA Approval ID: 2030668				
	Nominal voltage U_N	Nominal current I_N	Cross section AWG	Cross section mm^2
Use group B	600 V	40 A	20 - 8	-
Use group C	600 V	40 A	20 - 8	-
Use group D	600 V	5 A	20 - 8	-

 IECEE CB Scheme Approval ID: DE1-64372_B1_B2				
	Nominal voltage U_N	Nominal current I_N	Cross section AWG	Cross section mm^2
	1000 V	-	-	-

 EAC Approval ID: RU C-DE.BL08.B.00511				
---	--	--	--	--

 VDE Zeichengenehmigung Approval ID: 40043445				
	Nominal voltage U_N	Nominal current I_N	Cross section AWG	Cross section mm^2
	1000 V	-	-	0.5 - 6

 cULus Recognized Approval ID: E60425				
--	--	--	--	--

 cULus Recognized Approval ID: E60425				
--	--	--	--	--

PP-H 6/ 1-L - Plug

3061664

<https://www.phoenixcontact.com/pc/products/3061664>



Classifications

ECLASS

ECLASS-11.0	27141151
ECLASS-12.0	27141151
ECLASS-13.0	27250306

ETIM

ETIM 9.0	EC002021
----------	----------

UNSPSC

UNSPSC 21.0	39121400
-------------	----------

PP-H 6/ 1-L - Plug

3061664

<https://www.phoenixcontact.com/pc/products/3061664>



Environmental product compliance

China RoHS	Environmentally friendly use period: unlimited = EFUP-e
	No hazardous substances above threshold values

PP-H 6/ 1-L - Plug

3061664

<https://www.phoenixcontact.com/pc/products/3061664>



Accessories

PZ/2 - Strain relief

3040627

<https://www.phoenixcontact.com/pc/products/3040627>



Strain relief, width: 9.3 mm, height: 48.7 mm, number of positions: 2, color: black

PRZ - Latching

3040614

<https://www.phoenixcontact.com/pc/products/3040614>



Latching, number of positions: 2, length: 64 mm, color: orange

PP-H 6/ 1-L - Plug

3061664

<https://www.phoenixcontact.com/pc/products/3061664>



PR - Latching

3040559

<https://www.phoenixcontact.com/pc/products/3040559>



Latching, width: 4.4 mm, height: 29.8 mm, number of positions: 1, color: orange

PR/2 - Latching

3040630

<https://www.phoenixcontact.com/pc/products/3040630>



Latching, width: 10 mm, height: 29.8 mm, number of positions: 2, color: orange

PP-H 6/ 1-L - Plug

3061664

<https://www.phoenixcontact.com/pc/products/3061664>

PRT/2 - Latching

3040631

<https://www.phoenixcontact.com/pc/products/3040631>



Latching, can only be released using a screwdriver, width: 9 mm, height: 23.2 mm, number of positions: 2, color: orange

PH 6/2 - Cable housing

3000680

<https://www.phoenixcontact.com/pc/products/3000680>



Cable housing, pitch: 16.4 mm, depth: 52.3 mm, width: 16.4 mm, height: 21 mm, number of positions: 2, color: gray

PP-H 6/ 1-L - Plug

3061664

<https://www.phoenixcontact.com/pc/products/3061664>



PH 6/4 - Cable housing

3000682

<https://www.phoenixcontact.com/pc/products/3000682>



Cable housing, pitch: 32.8 mm, depth: 52.3 mm, width: 32.8 mm, height: 21 mm, number of positions: 4, color: gray

PH 6/5 - Cable housing

3000683

<https://www.phoenixcontact.com/pc/products/3000683>



Cable housing, pitch: 41 mm, depth: 52.3 mm, width: 41 mm, height: 21 mm, number of positions: 5, color: gray

PP-H 6/ 1-L - Plug

3061664

<https://www.phoenixcontact.com/pc/products/3061664>



PH 6/6 - Cable housing

3000684

<https://www.phoenixcontact.com/pc/products/3000684>



Cable housing, pitch: 49.2 mm, depth: 52.3 mm, width: 49.2 mm, height: 21 mm, number of positions: 6, color: gray

HSH-METALL-6/8 - Shield connection

3000770

<https://www.phoenixcontact.com/pc/products/3000770>



Shield connection, Suitable for PH 4/ and PH 6/ cable housings (pitches: 6 mm and 8 mm), material: Metal, color: silver/black

PP-H 6/ 1-L - Plug

3061664

<https://www.phoenixcontact.com/pc/products/3061664>



CPH 9-15 - Bend protection sleeve

3000768

<https://www.phoenixcontact.com/pc/products/3000768>



Bend protection sleeve, for cable diameter of 9 mm ... 15 mm, diameter: 12 mm, color: black

PP-H 6/ 1-M - Plug

3061693

<https://www.phoenixcontact.com/pc/products/3061693>



Plug, for self-assembly, nom. voltage: 1000 V, nominal current: 41 A, number of connections: 1, number of positions: 1, connection method: Push-in connection, 1 level, Rated cross section: 6 mm², cross section: 0.5 mm² - 10 mm², color: gray

PP-H 6/ 1-L - Plug

3061664

<https://www.phoenixcontact.com/pc/products/3061664>



PP-H 6/ 1-M BU - Plug

3061703

<https://www.phoenixcontact.com/pc/products/3061703>



Plug, for self-assembly, nom. voltage: 1000 V, nominal current: 41 A, number of connections: 1, number of positions: 1, connection method: Push-in connection, 1 level, Rated cross section: 6 mm², cross section: 0.5 mm² - 10 mm², color: blue

PP-H 6/ 1-M GNYE - Plug

3061716

<https://www.phoenixcontact.com/pc/products/3061716>



Plug, for self-assembly, nom. voltage: 1000 V, nominal current: 41 A, number of connections: 1, number of positions: 1, connection method: Push-in connection, 1 level, Rated cross section: 6 mm², cross section: 0.5 mm² - 10 mm², color: green/yellow

PP-H 6/ 1-L - Plug

3061664

<https://www.phoenixcontact.com/pc/products/3061664>

PP-H 6/ 1-R - Plug

3061729

<https://www.phoenixcontact.com/pc/products/3061729>



Plug, for self-assembly, nom. voltage: 1000 V, nominal current: 41 A, number of connections: 1, number of positions: 1, connection method: Push-in connection, 1 level, Rated cross section: 6 mm², cross section: 0.5 mm² - 10 mm², color: gray

PP-H 6/ 1-R BU - Plug

3061732

<https://www.phoenixcontact.com/pc/products/3061732>



Plug, for self-assembly, nom. voltage: 1000 V, nominal current: 41 A, number of connections: 1, number of positions: 1, connection method: Push-in connection, 1 level, Rated cross section: 6 mm², cross section: 0.5 mm² - 10 mm², color: blue

PP-H 6/ 1-L - Plug

3061664

<https://www.phoenixcontact.com/pc/products/3061664>



PP-H 6/ 1-R GNYE - Plug

3061745

<https://www.phoenixcontact.com/pc/products/3061745>



Plug, for self-assembly, nom. voltage: 1000 V, nominal current: 41 A, number of connections: 1, number of positions: 1, connection method: Push-in connection, 1 level, Rated cross section: 6 mm², cross section: 0.5 mm² - 10 mm², color: green/yellow

ZBF 8:UNBEDRUCKT - Zack Marker strip, flat

0808781

<https://www.phoenixcontact.com/pc/products/0808781>



Zack Marker strip, flat, Strip, white, unlabeled, can be labeled with: PLOTMARK, CMS-P1-PLOTTER, mounting type: snapped, for terminal block width: 8 mm, lettering field size: 5.15 x 8.15 mm, Number of individual labels: 10

PP-H 6/ 1-L - Plug

3061664

<https://www.phoenixcontact.com/pc/products/3061664>



ZBF 8 CUS - Zack Marker strip, flat

0825030

<https://www.phoenixcontact.com/pc/products/0825030>



Zack Marker strip, flat, can be ordered: Strip, white, labeled according to customer specifications, mounting type: snap into flat marker groove, for terminal block width: 8 mm, lettering field size: 5.15 x 8.15 mm, Number of individual labels: 10

ZBF 8,LGS:FORTL.ZAHLEN - Zack Marker strip, flat

0808804

<https://www.phoenixcontact.com/pc/products/0808804>



Zack Marker strip, flat, Strip, white, labeled, printed horizontally: consecutive numbers 1 ... 10, 11 ... 20, etc. up to 101 ... 110, mounting type: snapped, for terminal block width: 8 mm, lettering field size: 5.15 x 8.15 mm, Number of individual labels: 10

PP-H 6/ 1-L - Plug

3061664

<https://www.phoenixcontact.com/pc/products/3061664>



UC-TMF 8 - Marker for terminal blocks

0818137

<https://www.phoenixcontact.com/pc/products/0818137>



Marker for terminal blocks, Sheet, white, unlabeled, can be labeled with: BLUEMARK ID COLOR, BLUEMARK ID, BLUEMARK CLED, PLOTMARK, CMS-P1-PLOTTER, mounting type: snapped, for terminal block width: 8.2 mm, lettering field size: 7.6 x 5.1 mm, Number of individual labels: 56

UC-TMF 8 CUS - Marker for terminal blocks

0824654

<https://www.phoenixcontact.com/pc/products/0824654>



Marker for terminal blocks, can be ordered: by sheet, white, labeled according to customer specifications, mounting type: snap into flat marker groove, for terminal block width: 8.2 mm, lettering field size: 7.6 x 5.1 mm, Number of individual labels: 56

PP-H 6/ 1-L - Plug

3061664

<https://www.phoenixcontact.com/pc/products/3061664>



UCT-TMF 8 - Marker for terminal blocks

0828748

<https://www.phoenixcontact.com/pc/products/0828748>



Marker for terminal blocks, Sheet, white, unlabeled, can be labeled with: TOPMARK NEO, TOPMARK LASER, BLUEMARK ID COLOR, BLUEMARK ID, BLUEMARK CLED, THERMOMARK PRIME, THERMOMARK CARD 2.0, THERMOMARK CARD, mounting type: snapped, for terminal block width: 8.2 mm, lettering field size: 7.4 x 4.7 mm, Number of individual labels: 42

UCT-TMF 8 CUS - Marker for terminal blocks

0829672

<https://www.phoenixcontact.com/pc/products/0829672>



Marker for terminal blocks, can be ordered: by sheet, white, labeled according to customer specifications, mounting type: snap into flat marker groove, for terminal block width: 8.2 mm, lettering field size: 7.4 x 4.7 mm, Number of individual labels: 42

PP-H 6/ 1-L - Plug

3061664

<https://www.phoenixcontact.com/pc/products/3061664>



MPS-MT - Test plug

0201744

<https://www.phoenixcontact.com/pc/products/0201744>



Test plug, with solder connection up to 1 mm² conductor cross section, number of positions: 1, color: gray

MPS-IH WH - Insulating sleeve

0201663

<https://www.phoenixcontact.com/pc/products/0201663>

Insulating sleeve, color: white



PP-H 6/ 1-L - Plug

3061664

<https://www.phoenixcontact.com/pc/products/3061664>



MPS-IH RD - Insulating sleeve

0201676

<https://www.phoenixcontact.com/pc/products/0201676>

Insulating sleeve, color: red



MPS-IH BU - Insulating sleeve

0201689

<https://www.phoenixcontact.com/pc/products/0201689>

Insulating sleeve, color: blue

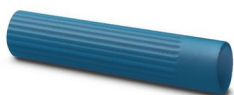

PP-H 6/ 1-L - Plug

3061664

<https://www.phoenixcontact.com/pc/products/3061664>



MPS-IH YE - Insulating sleeve

0201692

<https://www.phoenixcontact.com/pc/products/0201692>

Insulating sleeve, color: yellow



MPS-IH GN - Insulating sleeve

0201702

<https://www.phoenixcontact.com/pc/products/0201702>

Insulating sleeve, color: green



PP-H 6/ 1-L - Plug

3061664

<https://www.phoenixcontact.com/pc/products/3061664>



MPS-IH GY - Insulating sleeve

0201728

<https://www.phoenixcontact.com/pc/products/0201728>

Insulating sleeve, color: gray



MPS-IH BK - Insulating sleeve

0201731

<https://www.phoenixcontact.com/pc/products/0201731>

Insulating sleeve, color: black



PP-H 6/ 1-L - Plug

3061664

<https://www.phoenixcontact.com/pc/products/3061664>



SZF 2-0,8X4,0 - Screwdriver

1204520

<https://www.phoenixcontact.com/pc/products/1204520>



Actuation tool, for ST terminal blocks, also suitable for use as a bladed screwdriver, size: 0.8 x 4.0 x 100 mm, 2-component grip, with non-slip grip

Phoenix Contact 2024 © - all rights reserved

<https://www.phoenixcontact.com>

PHOENIX CONTACT GmbH & Co. KG

Flachsmarktstraße 8

D-32825 Blomberg

+49 (0) 5235-3 00

info@phoenixcontact.com