

SPB 2,5/ 1-M GNYE - Plug

3043158

<https://www.phoenixcontact.com/us/products/3043158>



Please be informed that the data shown in this PDF document is generated from our online catalog. Please find the complete data in the user documentation. Our general terms of use for downloads are valid.



Plug, nom. voltage: 500 V, nominal current: 24 A, number of positions: 1, connection method: Spring-cage connection, Rated cross section: 2.5 mm², cross section: 0.08 mm²- 4 mm², color: green-yellow

Product description

Connector element center, left housing with engagement pin, right opened without cover

Your advantages

- Plug with bridging option, for use with basic terminal blocks
- The plug with spring-cage connection is assembled directly on site by snapping together single-position plug elements
- The ST-COMBI plugs for self-assembly provide solutions that users can implement themselves

Commercial data

Item number	3043158
Packing unit	50 pc
Sales key	BE02
Product key	BE2144
Catalog page	Page 321 (C-1-2019)
GTIN	4017918895013
Weight per piece (including packing)	3.52 g
Weight per piece (excluding packing)	3.484 g
Customs tariff number	85366990
Country of origin	PL

SPB 2,5/ 1-M GNYE - Plug

3043158

<https://www.phoenixcontact.com/us/products/3043158>



Technical data

Product properties

Product type	Terminal plug
Number of positions	1
Pitch	5.2 mm
Potentials	1

Insulation characteristics

Overvoltage category	III
Degree of pollution	3

Electrical properties

Rated surge voltage	6 kV
---------------------	------

Connection data

Nominal cross section	2.5 mm ²
Stripping length	8 mm ... 10 mm
Internal cylindrical gage	A3
Connection in acc. with standard	IEC 61984
Conductor cross section rigid	0.08 mm ² ... 4 mm ²
Cross section AWG	28 ... 12 (converted acc. to IEC)
Conductor cross section flexible	0.08 mm ² ... 2.5 mm ²
Conductor cross section, flexible [AWG]	28 ... 14 (converted acc. to IEC)
Conductor cross-section flexible (ferrule without plastic sleeve)	0.14 mm ² ... 2.5 mm ²
Flexible conductor cross section (ferrule with plastic sleeve)	0.14 mm ² ... 2.5 mm ²
2 conductors with the same cross section, flexible, with TWIN ferrule with plastic sleeve	0.5 mm ²
Nominal current	24 A
Maximum load current	24 A (with 4 mm ² conductor cross section)
Nominal voltage	500 V
Nominal cross section	2.5 mm ²

Dimensions

Width	5.2 mm
Height	20 mm
Depth	39 mm
Length	20 mm
Pitch	5.2 mm

Material specifications

Color	green-yellow
Flammability rating according to UL 94	V0
Insulating material group	I

SPB 2,5/ 1-M GNYE - Plug



3043158

<https://www.phoenixcontact.com/us/products/3043158>

Insulating material	PA
Static insulating material application in cold	-60 °C
Temperature index of insulation material (DIN EN 60216-1 (VDE 0304-21))	130 °C
Relative insulation material temperature index (Elec., UL 746 B)	130 °C
Fire protection for rail vehicles (DIN EN 45545-2) R22	HL 1 - HL 3
Fire protection for rail vehicles (DIN EN 45545-2) R23	HL 1 - HL 3
Fire protection for rail vehicles (DIN EN 45545-2) R24	HL 1 - HL 3
Fire protection for rail vehicles (DIN EN 45545-2) R26	HL 1 - HL 3
Calorimetric heat release NFPA 130 (ASTM E 1354)	28 MJ/kg
Surface flammability NFPA 130 (ASTM E 162)	passed
Specific optical density of smoke NFPA 130 (ASTM E 662)	passed
Smoke gas toxicity NFPA 130 (SMP 800C)	passed

Environmental and real-life conditions

Ambient conditions

Ambient temperature (operation)	-60 °C (max. operating temperature see derating curve)
Ambient temperature (storage/transport)	-25 °C ... 60 °C ()
Ambient temperature (assembly)	-5 °C ... 70 °C
Ambient temperature (actuation)	-5 °C ... 70 °C
Permissible humidity (operation)	20 % ... 90 %
Permissible humidity (storage/transport)	30 % ... 70 %

Standards and regulations

Connection in acc. with standard	IEC 61984
----------------------------------	-----------

Drawings

Diagram

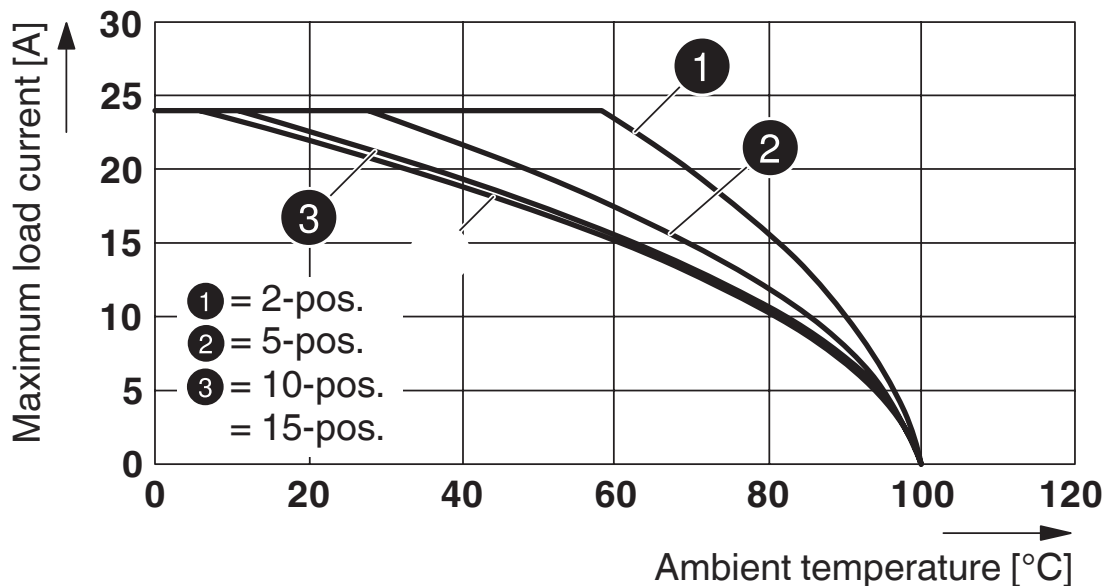

Derating curve for ST 2,5-QUATTRO/2P, ST 2,5-QUATTRO/4P and for all plug versions SP...

Diagram

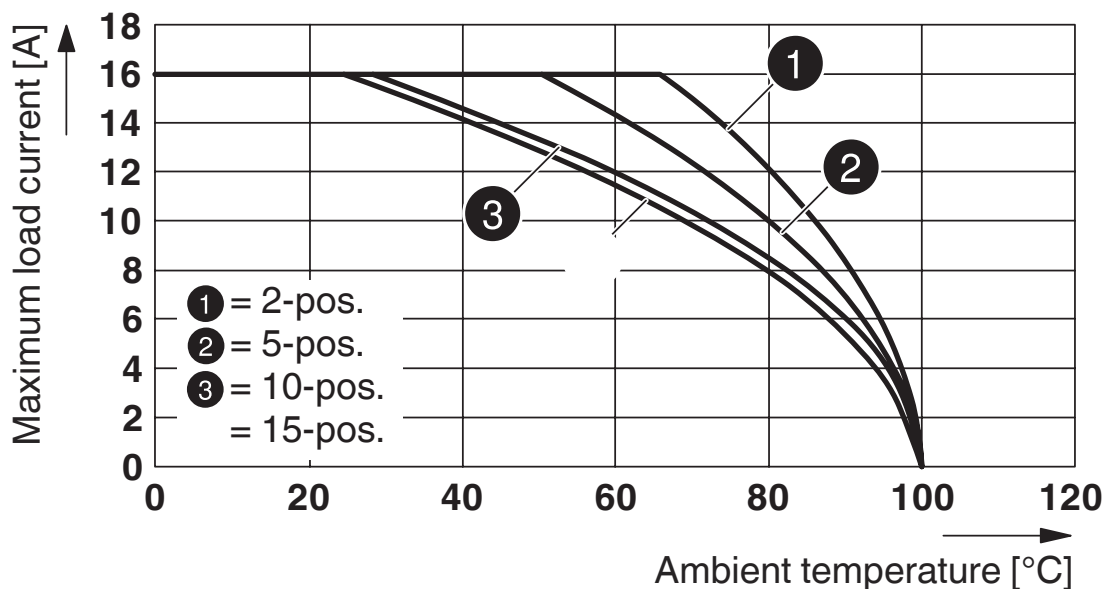

Derating curve for ST 2,5-TWIN-MT/1P, ST 2,5-TWIN-TG/1P and for all plug versions SP...

SPB 2,5/ 1-M GNYE - Plug

3043158

<https://www.phoenixcontact.com/us/products/3043158>

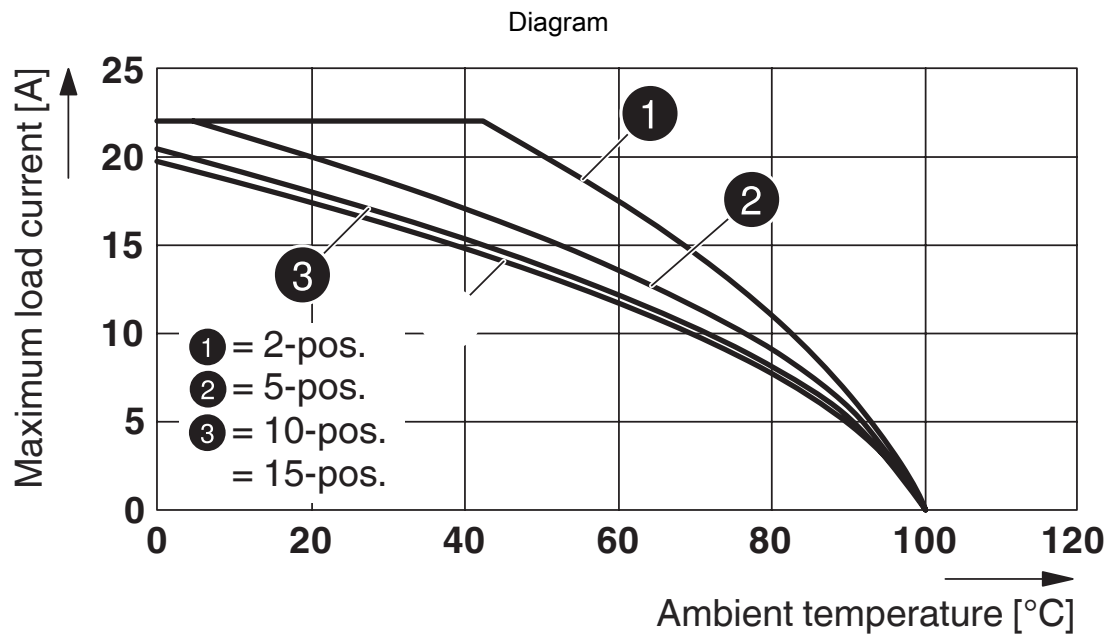

Derating curve for STTB 2,5/ 2P, STTB 2,5/ 2P-PV and for all plug versions SP...

SPB 2,5/ 1-M GNYE - Plug

3043158

<https://www.phoenixcontact.com/us/products/3043158>



Schematic diagram

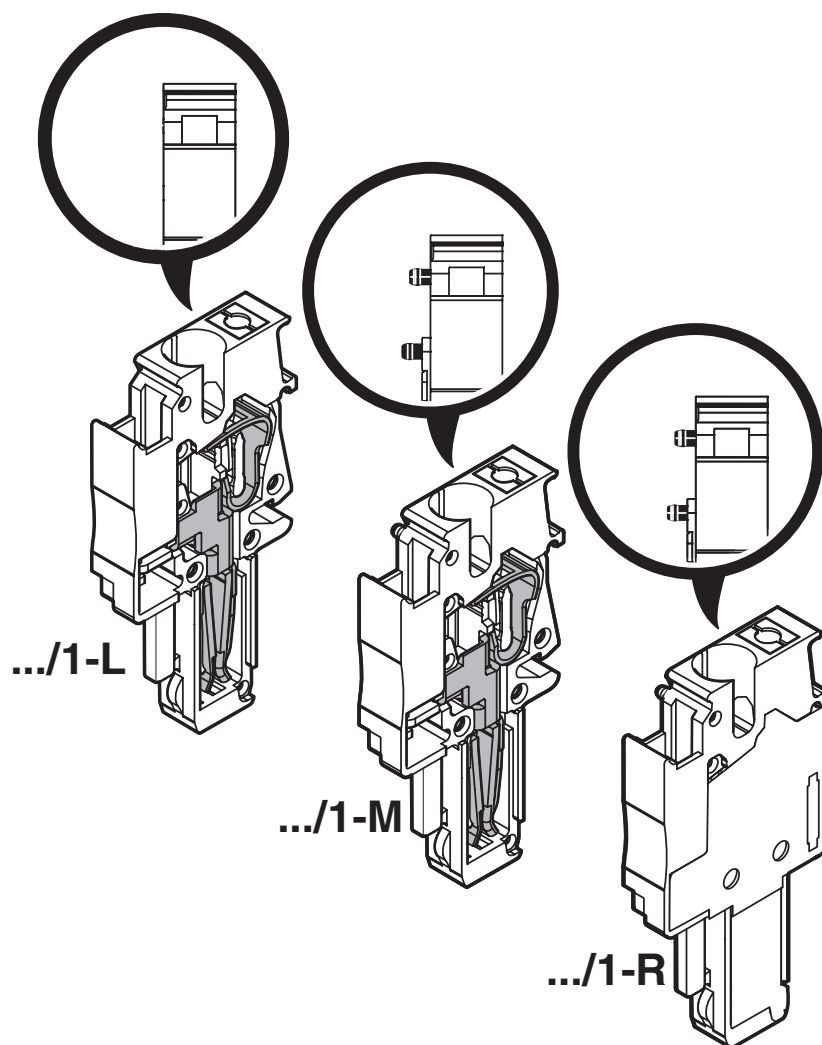

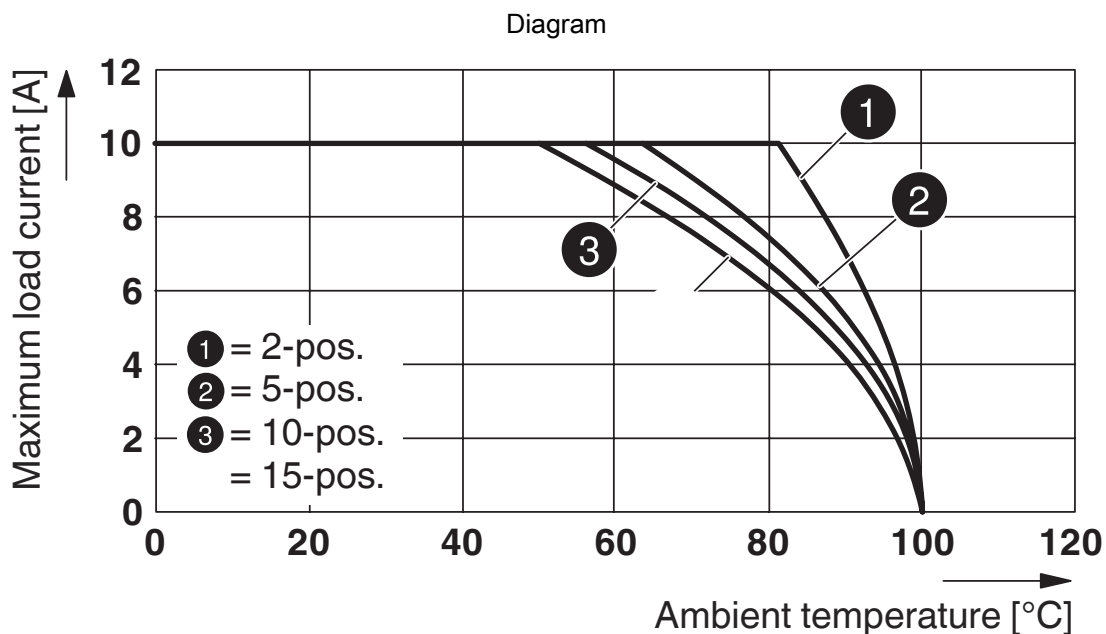

Derating curve for ST 2,5-4L/1P, ST 2,5-4L/2P and for all plug versions SP...

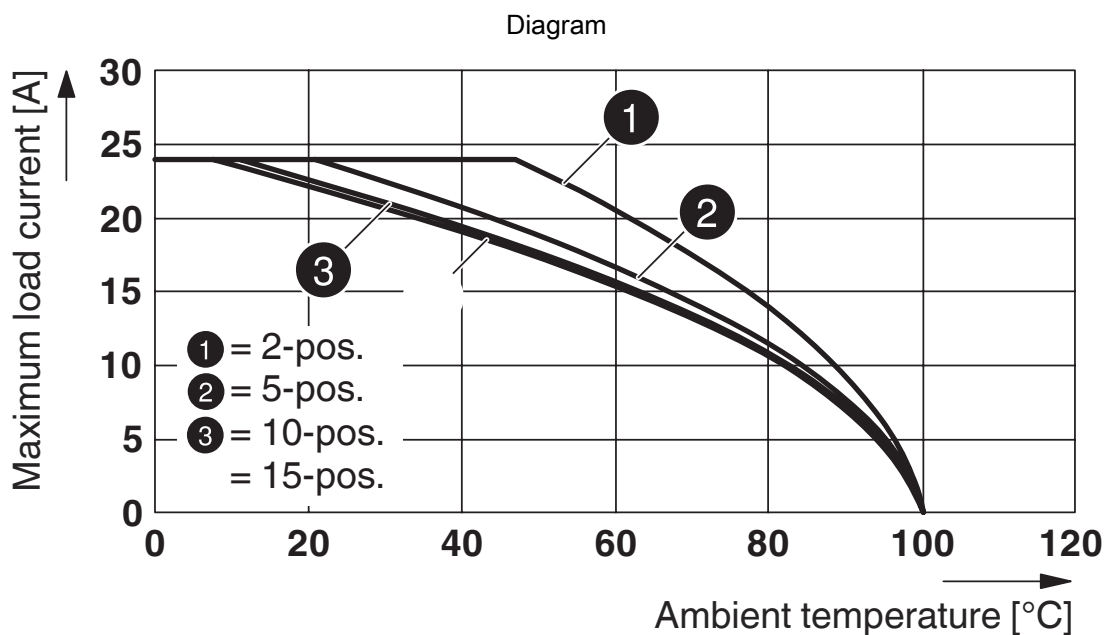

Derating curve for ST 2,5/ 1P, ST 2,5/ 2P, ST 2,5-TWIN/ 1P and for all plug versions SP...

SPB 2,5/ 1-M GNYE - Plug

3043158

<https://www.phoenixcontact.com/us/products/3043158>



Circuit diagram



SPB 2,5/ 1-M GNYE - Plug



3043158

<https://www.phoenixcontact.com/us/products/3043158>

Approvals

To download certificates, visit the product detail page: <https://www.phoenixcontact.com/us/products/3043158>

 CSA Approval ID: 13631				
	Nominal voltage U_N	Nominal current I_N	Cross section AWG	Cross section mm^2
Use group B	300 V	20 A	28 - 12	-
Use group C	300 V	20 A	28 - 12	-
Use group D	600 V	5 A	28 - 12	-

 IECEE CB Scheme Approval ID: DE1-62736/B1/B2				
--	--	--	--	--

 EAC Approval ID: RU C-DE.BL08.B.00511				
---	--	--	--	--

 LR Approval ID: LR2042068TA				
---	--	--	--	--

 RS Approval ID: 22.44.01.00083.250				
--	--	--	--	--

 BV Approval ID: 27721/B0 BV				
---	--	--	--	--

 VDE Zeichengenehmigung Approval ID: 40019518				
	Nominal voltage U_N	Nominal current I_N	Cross section AWG	Cross section mm^2
Only flexible conductors	500 V	-	-	0.2 - 2.5
Only rigid conductors	500 V	-	-	0.2 - 4

 cULus Recognized Approval ID: E60425				
--	--	--	--	--

SPB 2,5/ 1-M GNYE - Plug

3043158

<https://www.phoenixcontact.com/us/products/3043158>



cULus Recognized
Approval ID: E60425

DNV

Approval ID: TAE00001CS

SPB 2,5/ 1-M GNYE - Plug

3043158

<https://www.phoenixcontact.com/us/products/3043158>



Classifications

ECLASS

ECLASS-11.0	27141151
ECLASS-12.0	27141151
ECLASS-13.0	27250306

ETIM

ETIM 9.0	EC002021
----------	----------

UNSPSC

UNSPSC 21.0	39121400
-------------	----------

SPB 2,5/ 1-M GNYE - Plug

3043158

<https://www.phoenixcontact.com/us/products/3043158>



Environmental product compliance

China RoHS	Environmentally friendly use period: unlimited = EFUP-e
	No hazardous substances above threshold values

SPB 2,5/ 1-M GNYE - Plug

3043158

<https://www.phoenixcontact.com/us/products/3043158>



Accessories

i Note: Applying some accessories below might limit this product.

FBS 2-5 - Plug-in bridge

3030161

<https://www.phoenixcontact.com/us/products/3030161>



Plug-in bridge, pitch: 5.2 mm, number of positions: 2, length: 23 mm, color: red

i Max. current carrying capacity: 24 A

FBS 3-5 - Plug-in bridge

3030174

<https://www.phoenixcontact.com/us/products/3030174>



Plug-in bridge, pitch: 5.2 mm, number of positions: 3, length: 23 mm, color: red

i Max. current carrying capacity: 24 A

SPB 2,5/ 1-M GNYE - Plug

3043158

<https://www.phoenixcontact.com/us/products/3043158>



FBS 4-5 - Plug-in bridge

3030187

<https://www.phoenixcontact.com/us/products/3030187>



Plug-in bridge, pitch: 5.2 mm, number of positions: 4, length: 23 mm, color: red

 Max. current carrying capacity: 24 A

FBS 5-5 - Plug-in bridge

3030190

<https://www.phoenixcontact.com/us/products/3030190>



Plug-in bridge, pitch: 5.2 mm, number of positions: 5, length: 23 mm, color: red

 Max. current carrying capacity: 24 A

SPB 2,5/ 1-M GNYE - Plug

3043158

<https://www.phoenixcontact.com/us/products/3043158>



FBS 10-5 - Plug-in bridge

3030213

<https://www.phoenixcontact.com/us/products/3030213>



Plug-in bridge, pitch: 5.2 mm, number of positions: 10, length: 23 mm, color: red

 Max. current carrying capacity: 24 A

FBS 20-5 - Plug-in bridge

3030226

<https://www.phoenixcontact.com/us/products/3030226>



Plug-in bridge, pitch: 5.2 mm, number of positions: 20, color: red

 Max. current carrying capacity: 24 A

SPB 2,5/ 1-M GNYE - Plug

3043158

<https://www.phoenixcontact.com/us/products/3043158>



FBS 50-5 - Plug-in bridge

3038930

<https://www.phoenixcontact.com/us/products/3038930>



Plug-in bridge, pitch: 5.2 mm, number of positions: 50, color: red

 Max. current carrying capacity: 24 A

FBS 2-5 BU - Plug-in bridge

3036877

<https://www.phoenixcontact.com/us/products/3036877>



Plug-in bridge, pitch: 5.2 mm, number of positions: 2, color: blue

 Max. current carrying capacity: 24 A

SPB 2,5/ 1-M GNYE - Plug

3043158

<https://www.phoenixcontact.com/us/products/3043158>



FBS 3-5 BU - Plug-in bridge

3036880

<https://www.phoenixcontact.com/us/products/3036880>



Plug-in bridge, pitch: 5.2 mm, number of positions: 3, color: blue

 Max. current carrying capacity: 24 A

FBS 4-5 BU - Plug-in bridge

3036893

<https://www.phoenixcontact.com/us/products/3036893>



Plug-in bridge, pitch: 5.2 mm, number of positions: 4, color: blue

 Max. current carrying capacity: 24 A

SPB 2,5/ 1-M GNYE - Plug

3043158

<https://www.phoenixcontact.com/us/products/3043158>



FBS 5-5 BU - Plug-in bridge

3036903

<https://www.phoenixcontact.com/us/products/3036903>



Plug-in bridge, pitch: 5.2 mm, number of positions: 5, color: blue

 Max. current carrying capacity: 24 A

FBS 10-5 BU - Plug-in bridge

3036916

<https://www.phoenixcontact.com/us/products/3036916>



Plug-in bridge, pitch: 5.2 mm, number of positions: 10, color: blue

 Max. current carrying capacity: 24 A

SPB 2,5/ 1-M GNYE - Plug

3043158

<https://www.phoenixcontact.com/us/products/3043158>



FBS 20-5 BU - Plug-in bridge

3036929

<https://www.phoenixcontact.com/us/products/3036929>



Plug-in bridge, pitch: 5.2 mm, number of positions: 20, color: blue

 Max. current carrying capacity: 24 A

FBS 50-5 BU - Plug-in bridge

3032114

<https://www.phoenixcontact.com/us/products/3032114>



Plug-in bridge, pitch: 5.2 mm, number of positions: 50, color: blue

 Max. current carrying capacity: 24 A

SPB 2,5/ 1-M GNYE - Plug

3043158

<https://www.phoenixcontact.com/us/products/3043158>



FBS 2-5 GY - Plug-in bridge

3038969

<https://www.phoenixcontact.com/us/products/3038969>



Plug-in bridge, pitch: 5.2 mm, number of positions: 2, color: gray

 Max. current carrying capacity: 24 A

FBS 3-5 GY - Plug-in bridge

3038972

<https://www.phoenixcontact.com/us/products/3038972>



Plug-in bridge, pitch: 5.2 mm, number of positions: 3, color: gray

 Max. current carrying capacity: 24 A

SPB 2,5/ 1-M GNYE - Plug

3043158

<https://www.phoenixcontact.com/us/products/3043158>



FBS 4-5 GY - Plug-in bridge

3038985

<https://www.phoenixcontact.com/us/products/3038985>



Plug-in bridge, pitch: 5.2 mm, number of positions: 4, color: gray

 Max. current carrying capacity: 24 A

FBS 5-5 GY - Plug-in bridge

3038998

<https://www.phoenixcontact.com/us/products/3038998>



Plug-in bridge, pitch: 5.2 mm, number of positions: 5, color: gray

 Max. current carrying capacity: 24 A

SPB 2,5/ 1-M GNYE - Plug

3043158

<https://www.phoenixcontact.com/us/products/3043158>



FBS 10-5 GY - Plug-in bridge

3039007

<https://www.phoenixcontact.com/us/products/3039007>



Plug-in bridge, pitch: 5.2 mm, number of positions: 10, color: gray

 Max. current carrying capacity: 24 A

FBS 20-5 GY - Plug-in bridge

3038671

<https://www.phoenixcontact.com/us/products/3038671>



Plug-in bridge, pitch: 5.2 mm, number of positions: 20, color: gray

 Max. current carrying capacity: 24 A

SPB 2,5/ 1-M GNYE - Plug

3043158

<https://www.phoenixcontact.com/us/products/3043158>



FBS 50-5 GY - Plug-in bridge

3032127

<https://www.phoenixcontact.com/us/products/3032127>



Plug-in bridge, pitch: 5.2 mm, number of positions: 50, color: gray

 Max. current carrying capacity: 24 A

FBSR 2-5 - Plug-in bridge

3033702

<https://www.phoenixcontact.com/us/products/3033702>



Plug-in bridge, pitch: 5.2 mm, number of positions: 2, color: red

 Max. current carrying capacity: 17.5 A

SPB 2,5/ 1-M GNYE - Plug

3043158

<https://www.phoenixcontact.com/us/products/3043158>



FBSR 3-5 - Plug-in bridge

3001591

<https://www.phoenixcontact.com/us/products/3001591>



Plug-in bridge, pitch: 5.2 mm, number of positions: 3, color: red

 Max. current carrying capacity: 17.5 A

FBSR 4-5 - Plug-in bridge

3001592

<https://www.phoenixcontact.com/us/products/3001592>



Plug-in bridge, pitch: 5.2 mm, number of positions: 4, color: red

 Max. current carrying capacity: 17.5 A

SPB 2,5/ 1-M GNYE - Plug

3043158

<https://www.phoenixcontact.com/us/products/3043158>



FBSR 5-5 - Plug-in bridge

3001593

<https://www.phoenixcontact.com/us/products/3001593>



Plug-in bridge, pitch: 5.2 mm, number of positions: 5, color: red

 Max. current carrying capacity: 17.5 A

FBSR 10-5 - Plug-in bridge

3033710

<https://www.phoenixcontact.com/us/products/3033710>



Plug-in bridge, pitch: 5.2 mm, number of positions: 10, color: red

 Max. current carrying capacity: 17.5 A

SPB 2,5/ 1-M GNYE - Plug

3043158

<https://www.phoenixcontact.com/us/products/3043158>



PDZ/2 - Strain relief

3040562

<https://www.phoenixcontact.com/us/products/3040562>



Strain relief, width: 9.6 mm, height: 28.9 mm, number of positions: 2, color: black

PDZ/4 - Strain relief

3040575

<https://www.phoenixcontact.com/us/products/3040575>



Strain relief, width: 19.8 mm, height: 28.9 mm, number of positions: 4, color: black

SPB 2,5/ 1-M GNYE - Plug

3043158

<https://www.phoenixcontact.com/us/products/3043158>



PR - Latching

3040559

<https://www.phoenixcontact.com/us/products/3040559>



Latching, width: 4.4 mm, height: 29.8 mm, number of positions: 1, color: orange

PR/2 - Latching

3040630

<https://www.phoenixcontact.com/us/products/3040630>



Latching, width: 10 mm, height: 29.8 mm, number of positions: 2, color: orange

SPB 2,5/ 1-M GNYE - Plug

3043158

<https://www.phoenixcontact.com/us/products/3043158>



PRT/2 - Latching

3040631

<https://www.phoenixcontact.com/us/products/3040631>



Latching, can only be released using a screwdriver, width: 9 mm, height: 23.2 mm, number of positions: 2, color: orange

PRZ - Latching

3040614

<https://www.phoenixcontact.com/us/products/3040614>



Latching, number of positions: 2, length: 64 mm, color: orange

SPB 2,5/ 1-M GNYE - Plug

3043158

<https://www.phoenixcontact.com/us/products/3043158>



SPB 2,5/ 1-L - Plug

3043103

<https://www.phoenixcontact.com/us/products/3043103>



Plug, nom. voltage: 500 V, nominal current: 24 A, number of positions: 1, connection method: Spring-cage connection, Rated cross section: 2.5 mm², cross section: 0.08 mm²- 4 mm², color: gray

SPB 2,5/ 1-L BK - Plug

3215025

<https://www.phoenixcontact.com/us/products/3215025>



Plug, nom. voltage: 500 V, nominal current: 24 A, number of positions: 1, connection method: Spring-cage connection, Rated cross section: 2.5 mm², cross section: 0.08 mm²- 4 mm², color: black

SPB 2,5/ 1-M GNYE - Plug

3043158

<https://www.phoenixcontact.com/us/products/3043158>



SPB 2,5/ 1-L BU - Plug

3043116

<https://www.phoenixcontact.com/us/products/3043116>



Plug, nom. voltage: 500 V, nominal current: 24 A, number of positions: 1, connection method: Spring-cage connection, Rated cross section: 2.5 mm², cross section: 0.08 mm²- 4 mm², color: blue

SPB 2,5/ 1-L GNYE - Plug

3043129

<https://www.phoenixcontact.com/us/products/3043129>



Plug, nom. voltage: 500 V, nominal current: 24 A, number of positions: 1, connection method: Spring-cage connection, Rated cross section: 2.5 mm², cross section: 0.08 mm²- 4 mm², color: green-yellow

SPB 2,5/ 1-M GNYE - Plug

3043158

<https://www.phoenixcontact.com/us/products/3043158>



SPB 2,5/ 1-M - Plug

3043132

<https://www.phoenixcontact.com/us/products/3043132>



Plug, nom. voltage: 500 V, nominal current: 24 A, number of positions: 1, connection method: Spring-cage connection, Rated cross section: 2.5 mm², cross section: 0.08 mm²- 4 mm², color: gray

SPB 2,5/ 1-M BK - Plug

3215012

<https://www.phoenixcontact.com/us/products/3215012>



Plug, nom. voltage: 500 V, nominal current: 24 A, number of positions: 1, connection method: Spring-cage connection, Rated cross section: 2.5 mm², cross section: 0.08 mm²- 4 mm², color: black

SPB 2,5/ 1-M GNYE - Plug

3043158

<https://www.phoenixcontact.com/us/products/3043158>



SPB 2,5/ 1-M BU - Plug

3043145

<https://www.phoenixcontact.com/us/products/3043145>



Plug, nom. voltage: 500 V, nominal current: 24 A, number of positions: 1, connection method: Spring-cage connection, Rated cross section: 2.5 mm², cross section: 0.08 mm²- 4 mm², color: blue

SPB 2,5/ 1-M GNYE - Plug

3043158

<https://www.phoenixcontact.com/us/products/3043158>



Plug, nom. voltage: 500 V, nominal current: 24 A, number of positions: 1, connection method: Spring-cage connection, Rated cross section: 2.5 mm², cross section: 0.08 mm²- 4 mm², color: green-yellow

SPB 2,5/ 1-M GNYE - Plug

3043158

<https://www.phoenixcontact.com/us/products/3043158>



SPB 2,5/ 1-R - Plug

3043161

<https://www.phoenixcontact.com/us/products/3043161>



Plug, nom. voltage: 500 V, nominal current: 24 A, number of positions: 1, connection method: Spring-cage connection, Rated cross section: 2.5 mm², cross section: 0.08 mm²- 4 mm², color: gray

SPB 2,5/ 1-R BK - Plug

3215038

<https://www.phoenixcontact.com/us/products/3215038>



Plug, nom. voltage: 500 V, nominal current: 24 A, number of positions: 1, connection method: Spring-cage connection, Rated cross section: 2.5 mm², cross section: 0.08 mm²- 4 mm², color: black

SPB 2,5/ 1-M GNYE - Plug

3043158

<https://www.phoenixcontact.com/us/products/3043158>



SPB 2,5/ 1-R BU - Plug

3043174

<https://www.phoenixcontact.com/us/products/3043174>



Plug, nom. voltage: 500 V, nominal current: 24 A, number of positions: 1, connection method: Spring-cage connection, Rated cross section: 2.5 mm², cross section: 0.08 mm²- 4 mm², color: blue

SPB 2,5/ 1-R GNYE - Plug

3043187

<https://www.phoenixcontact.com/us/products/3043187>



Plug, nom. voltage: 500 V, nominal current: 24 A, number of positions: 1, connection method: Spring-cage connection, Rated cross section: 2.5 mm², cross section: 0.08 mm²- 4 mm², color: green-yellow

SPB 2,5/ 1-M GNYE - Plug

3043158

<https://www.phoenixcontact.com/us/products/3043158>



ZBF 5:UNBEDRUCKT - Zack Marker strip, flat

0808642

<https://www.phoenixcontact.com/us/products/0808642>



Zack Marker strip, flat, Strip, white, unlabeled, can be labeled with: PLOTMARK, CMS-P1-PLOTTER, mounting type: snapped, for terminal block width: 5 mm, lettering field size: 5.1 x 5.2 mm, Number of individual labels: 10

ZBF 5 CUS - Zack Marker strip, flat

0825025

<https://www.phoenixcontact.com/us/products/0825025>



Zack Marker strip, flat, can be ordered: Strip, white, labeled according to customer specifications, mounting type: snap into flat marker groove, for terminal block width: 5 mm, lettering field size: 5.15 x 5.15 mm, Number of individual labels: 10

SPB 2,5/ 1-M GNYE - Plug

3043158

<https://www.phoenixcontact.com/us/products/3043158>



ZBF 5,LGS:FORTL.ZAHLEN - Zack Marker strip, flat

0808671

<https://www.phoenixcontact.com/us/products/0808671>



Zack Marker strip, flat, Strip, white, labeled, printed horizontally: consecutive numbers 1 ... 10, 11 ... 20, etc. up to 491 ... 500, mounting type: snapped, for terminal block width: 5 mm, lettering field size: 5.15 x 5.15 mm, Number of individual labels: 10

ZBF 5,QR:FORTL.ZAHLEN - Zack Marker strip, flat

0808697

<https://www.phoenixcontact.com/us/products/0808697>



Zack Marker strip, flat, Strip, white, labeled, Printed vertically: consecutive numbers 1 ... 10, 11 ... 20, etc. up to 91 ... 100, mounting type: snapped, for terminal block width: 5 mm, lettering field size: 5.15 x 5.15 mm, Number of individual labels: 10

SPB 2,5/ 1-M GNYE - Plug

3043158

<https://www.phoenixcontact.com/us/products/3043158>



ZBF 5,LGS:GERADE ZAHLEN - Zack Marker strip, flat

0810821

<https://www.phoenixcontact.com/us/products/0810821>



Zack Marker strip, flat, Strip, white, labeled, printed horizontally: consecutive even numbers 2 ... 20, 22 ... 40, etc. up to 82 ... 100, mounting type: snapped, for terminal block width: 5 mm, lettering field size: 5.15 x 5.15 mm, Number of individual labels: 10

ZBF 5,LGS:UNGERADE ZAHLEN - Zack Marker strip, flat

0810863

<https://www.phoenixcontact.com/us/products/0810863>



Zack Marker strip, flat, Strip, white, labeled, printed horizontally: Odd numbers 1 - 19, 21 - 39, etc. up to 81 - 99, mounting type: snapped, for terminal block width: 5 mm, lettering field size: 5.15 x 5.15 mm, Number of individual labels: 10

SPB 2,5/ 1-M GNYE - Plug

3043158

<https://www.phoenixcontact.com/us/products/3043158>



UC-TMF 5 - Marker for terminal blocks

0818153

<https://www.phoenixcontact.com/us/products/0818153>



Marker for terminal blocks, Sheet, white, unlabeled, can be labeled with: BLUEMARK ID COLOR, BLUEMARK ID, BLUEMARK CLED, PLOTMARK, CMS-P1-PLOTTER, mounting type: snapped, for terminal block width: 5.2 mm, lettering field size: 4.6 x 5.1 mm, Number of individual labels: 96

UC-TMF 5 CUS - Marker for terminal blocks

0824638

<https://www.phoenixcontact.com/us/products/0824638>



Marker for terminal blocks, can be ordered: by sheet, white, labeled according to customer specifications, mounting type: snap into flat marker groove, for terminal block width: 5.2 mm, lettering field size: 4.6 x 5.1 mm, Number of individual labels: 96

SPB 2,5/ 1-M GNYE - Plug

3043158

<https://www.phoenixcontact.com/us/products/3043158>



UCT-TMF 5 - Marker for terminal blocks

0828744

<https://www.phoenixcontact.com/us/products/0828744>



Marker for terminal blocks, Sheet, white, unlabeled, can be labeled with: TOPMARK NEO, TOPMARK LASER, BLUEMARK ID COLOR, BLUEMARK ID, BLUEMARK CLED, THERMOMARK PRIME, THERMOMARK CARD 2.0, THERMOMARK CARD, mounting type: snapped, for terminal block width: 5.2 mm, lettering field size: 4.4 x 4.7 mm, Number of individual labels: 72

UCT-TMF 5 CUS - Marker for terminal blocks

0829658

<https://www.phoenixcontact.com/us/products/0829658>



Marker for terminal blocks, can be ordered: by sheet, white, labeled according to customer specifications, mounting type: snap into flat marker groove, for terminal block width: 5.2 mm, lettering field size: 4.4 x 4.7 mm, Number of individual labels: 72

SPB 2,5/ 1-M GNYE - Plug

3043158

<https://www.phoenixcontact.com/us/products/3043158>



ISH 2,5/0,2 - Insulating sleeve

3002843

<https://www.phoenixcontact.com/us/products/3002843>



Insulating sleeve, color: white

ISH 2,5/0,5 - Insulating sleeve

3002856

<https://www.phoenixcontact.com/us/products/3002856>



Insulating sleeve, color: gray

SPB 2,5/ 1-M GNYE - Plug

3043158

<https://www.phoenixcontact.com/us/products/3043158>



ISH 2,5/1,0 - Insulating sleeve

3002869

<https://www.phoenixcontact.com/us/products/3002869>



Insulating sleeve, color: black

B-STIFT - Marker pen

1051993

<https://www.phoenixcontact.com/us/products/1051993>



Marker pen, for manual labeling of unprinted Zack strips, smear-proof and waterproof, line thickness 0.5 mm

SPB 2,5/ 1-M GNYE - Plug

3043158

<https://www.phoenixcontact.com/us/products/3043158>



X-PEN 0,35 - Marker pen

0811228

<https://www.phoenixcontact.com/us/products/0811228>



Marker pen without ink cartridge, for manual labeling of markers, labeling extremely wipe-proof, line thickness 0.35 mm

ST-BW - Actuation tool

1207608

<https://www.phoenixcontact.com/us/products/1207608>



Actuation tool, for all 2.5 mm² - 4.0 mm² spring-cages

SPB 2,5/ 1-M GNYE - Plug

3043158

<https://www.phoenixcontact.com/us/products/3043158>



DFS-SPB 2,5 - Flange cover

3061444

<https://www.phoenixcontact.com/us/products/3061444>

Flange cover, width: 4.5 mm, height: 24.7 mm, color: gray



Phoenix Contact 2024 © - all rights reserved

<https://www.phoenixcontact.com>

Phoenix Contact USA
586 Fulling Mill Road
Middletown, PA 17057, United States
(+717) 944-1300
info@phoenixcon.com