

REL-MR- 12DC/21-21AU - Single relay



2961299

<https://www.phoenixcontact.com/ae/products/2961299>

Please be informed that the data shown in this PDF document is generated from our online catalog. Please find the complete data in the user documentation. Our general terms of use for downloads are valid.



Plug-in miniature power relay, with multi-layer gold contact, 2 changeover contacts, input voltage 12 V DC

Your advantages

- RT III-proof (wash-proof)

Commercial data

Item number	2961299
Packing unit	10 pc
Minimum order quantity	10 pc
Sales key	CK6
Product key	CK6936
Catalog page	Page 290 (C-5-2019)
GTIN	4017918164041
Weight per piece (including packing)	16.34 g
Weight per piece (excluding packing)	14.98 g
Customs tariff number	85364900
Country of origin	AT

Technical data

Product properties

Product type	Single relay
Operating mode	100% operating factor
Mechanical service life	3x 10 ⁷ cycles

Data management status

Date of last data management	02.05.2024
------------------------------	------------

Insulation characteristics

Insulation	Basic insulation
------------	------------------

Insulation characteristics

Insulation	Basic insulation
Overvoltage category	III
Pollution degree	3

Electrical properties

Service life electrical	see diagram
Maximum power dissipation for nominal condition	0.4 W
Test voltage (Winding/contact)	5 kV AC (50 Hz, 1 min., winding/contact)
Test voltage (Contact/contact)	2.5 kV AC (50 Hz, 1 min., contact/contact)

Input data

Coil side

Nominal input voltage U_N	12 V DC
Input voltage range	7.8 V DC ... 29.76 V DC
Drive and function	monostable
Drive (polarity)	non-polarized
Typical input current at U_N	33 mA
Typical response time	7 ms
Typical release time	3 ms
Coil resistance	360 Ω \pm 10 % (at 20 °C)

Output data

Switching

Contact switching type	2 changeover contacts
Type of switch contact	Single contact
Contact material	AgNi, hard gold-plated
Maximum switching voltage	30 V AC
	36 V DC
Minimum switching voltage	100 mV (at 10 mA)
Limiting continuous current	50 mA

REL-MR- 12DC/21-21AU - Single relay



2961299

<https://www.phoenixcontact.com/ae/products/2961299>

Maximum inrush current	50 mA
Min. switching current	1 mA (at 24 V)
Interrupting rating (ohmic load) max.	1.2 W (at 24 V DC)
Switching capacity min.	0.12 W

Switching: when the gold layer is destroyed

Note	the following values are applicable if a gold layer is destroyed
Contact material	AgNi
Maximum switching voltage	250 V
Minimum switching voltage	5 V (at 10 mA)
Limiting continuous current	8 A
Maximum inrush current	15 A (300 ms)
Min. switching current	10 mA (At 5 V)
Interrupting rating (ohmic load) max.	190 W (at 24 V DC) 85 W (at 48 V DC) 60 W (at 60 V DC) 44 W (at 110 V DC) 60 W (at 220 V DC) 2000 VA (for 250 V AC)
Switching capacity	2 A (at 24 V, DC13) 0.2 A (at 110 V, DC13) 0.2 A (at 250 V, DC13) 2 A (at 24 V, AC15) 2 A (at 120 V, AC15) 2 A (at 250 V, AC15)

Connection data

Connection method	Plug / solder connection
-------------------	--------------------------

Dimensions

Dimensional drawing	
Width	12.7 mm
Height	29 mm
Depth	15.7 mm

Material specifications

Color	white (RAL 9010)
-------	------------------

Environmental and real-life conditions

REL-MR- 12DC/21-21AU - Single relay



2961299

<https://www.phoenixcontact.com/ae/products/2961299>

Ambient conditions

Degree of protection	RT III
Ambient temperature (operation)	-40 °C ... 85 °C
Ambient temperature (storage/transport)	-40 °C ... 85 °C

Approvals

Corrosive gas test

Identification	ISA-S71.04. G3 Harsh Group
	EN 60068-2-60

Standards and regulations

Standards/regulations	IEC 60664
	EN 50178
	EN 61810-1

Mounting

Assembly note	Can be aligned without spacing ($> 70 \text{ °C} \geq 2.5 \text{ mm}$)
Mounting position	any

REL-MR- 12DC/21-21AU - Single relay

2961299

<https://www.phoenixcontact.com/ae/products/2961299>

Drawings

Dimensional drawing

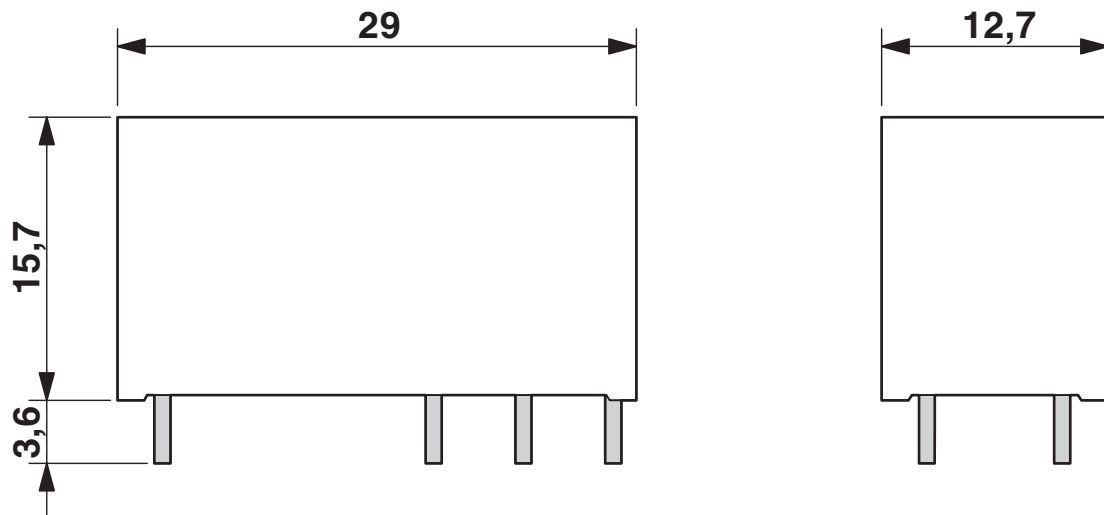

Circuit diagram

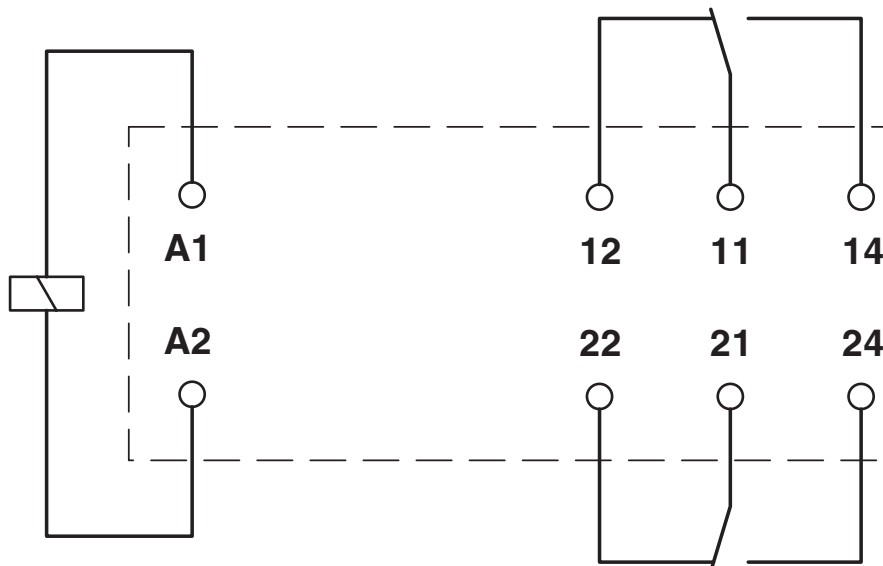

Diagram

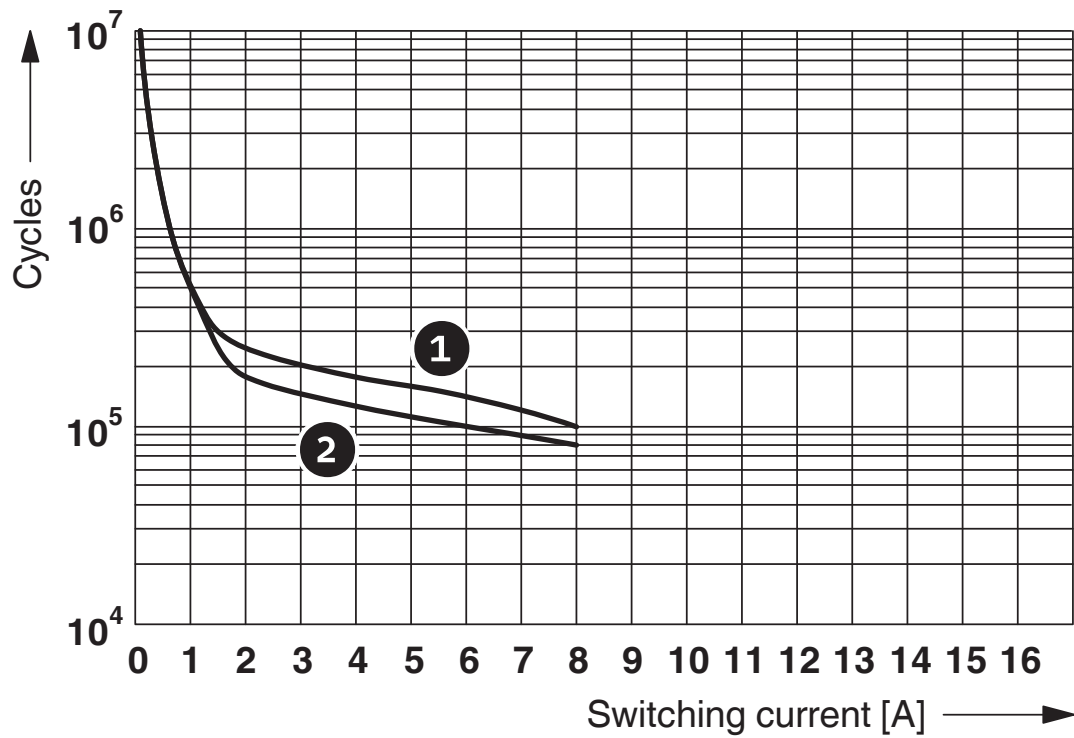

- ① 250 V AC, ohmic load (DC coils)
- ② 250 V AC, ohmic load (AC coils)

Electrical service life

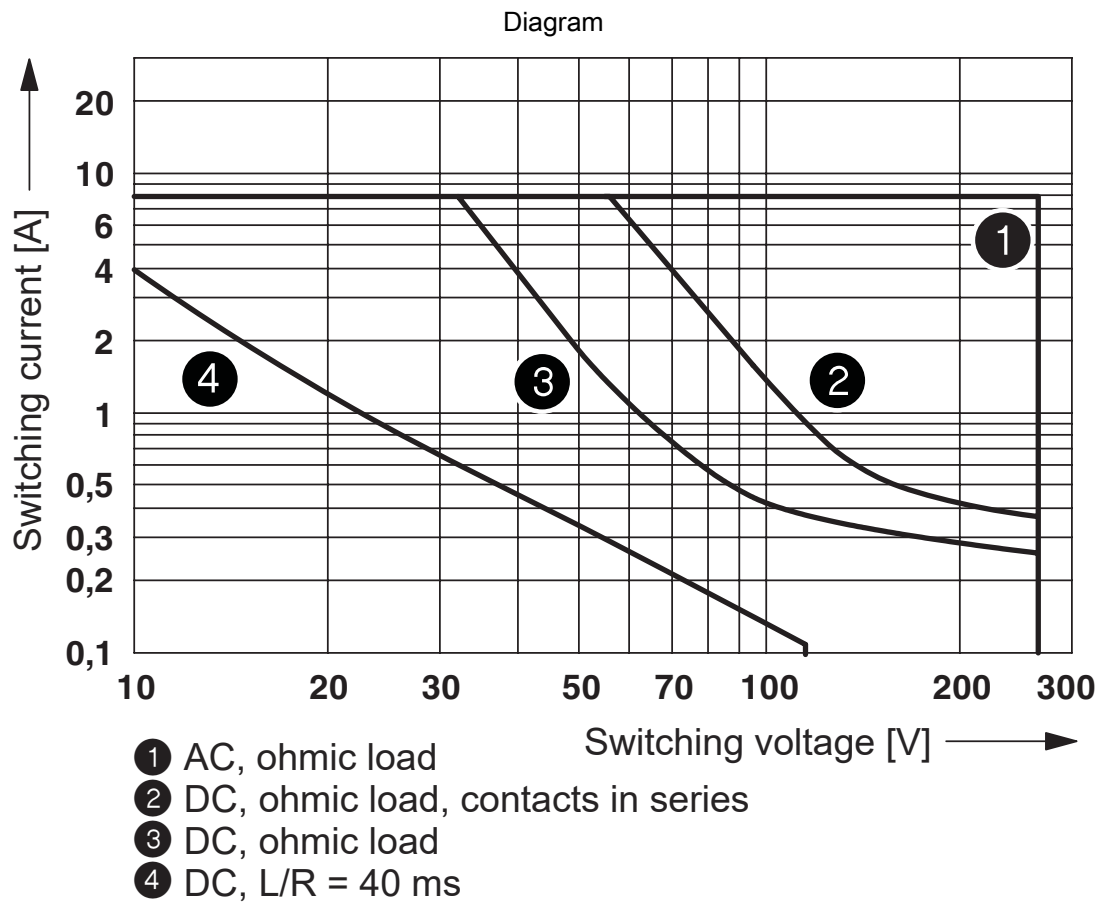

Interrupting rating

Diagram

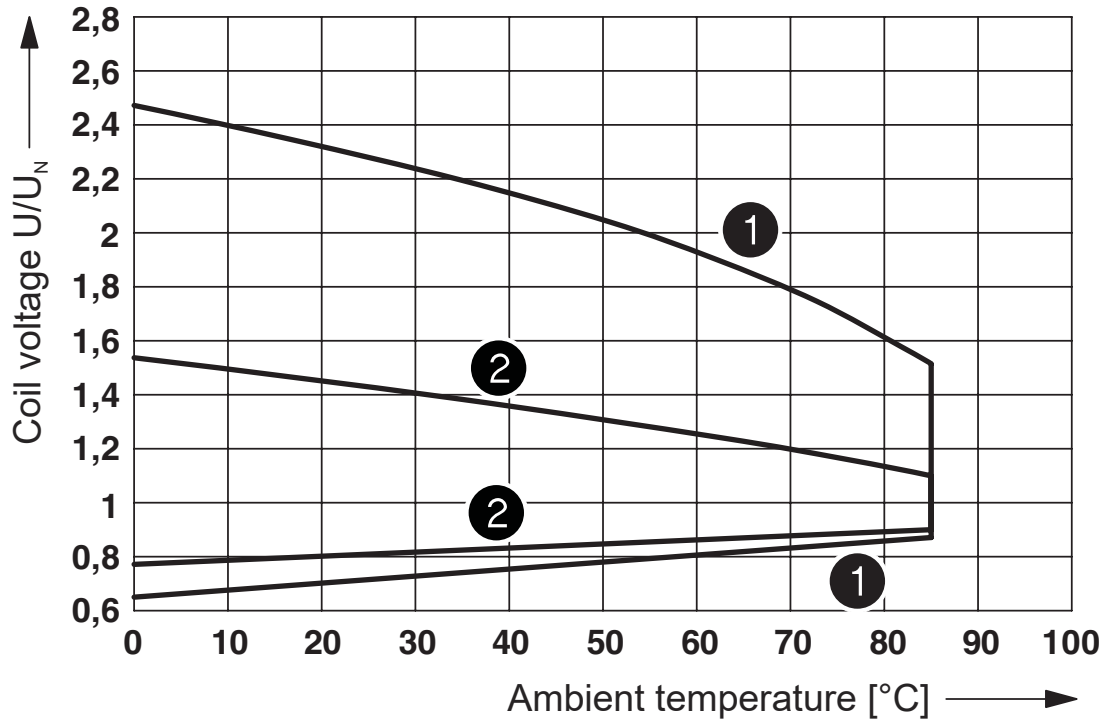

- ① DC coils
- ② AC coils

Operating voltage range

Diagram

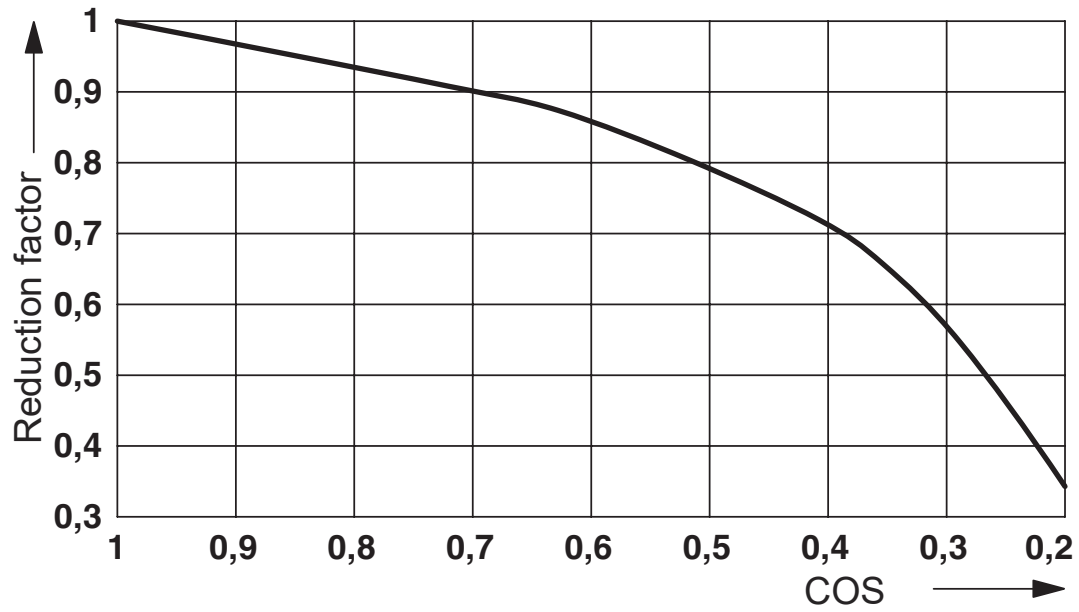

Service life reduction factor with various cos phi

Diagram

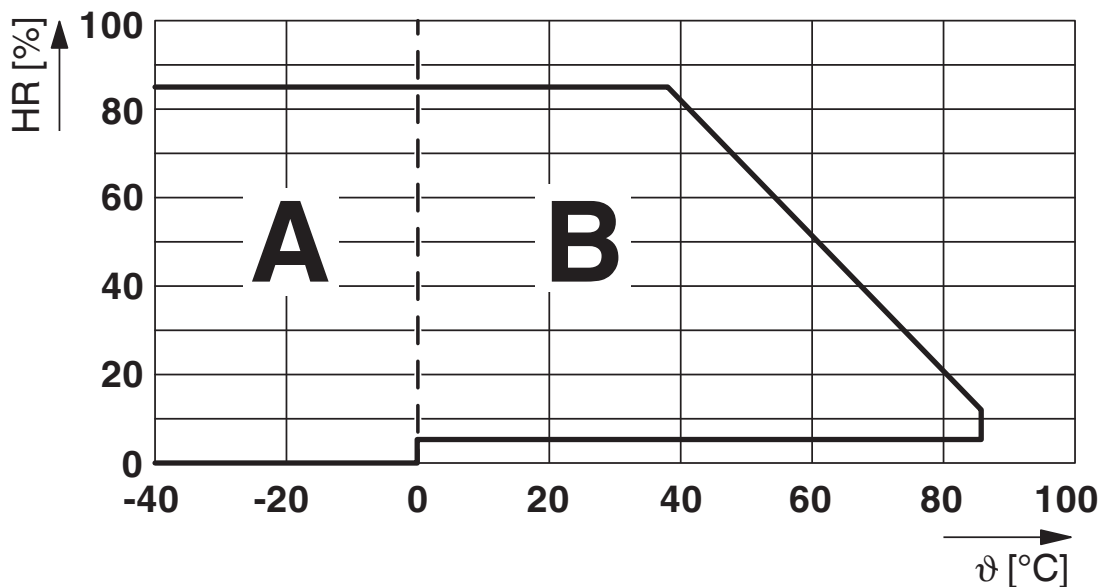

Permissible humidity for operation and storage.

The maximum permissible ambient temperature as specified in the data sheet must be observed.

Area A: Ice buildup at ambient temperatures $\leq 0^\circ\text{C}$ must be prevented

Area B: Condensation at ambient temperatures $> 0^\circ\text{C}$ must be prevented

On 30 full days that are naturally distributed across an entire year, a humidity level of 95% is permissible at an ambient temperature $\leq 25^\circ\text{C}$.

Drilling plan/solder pad geometry

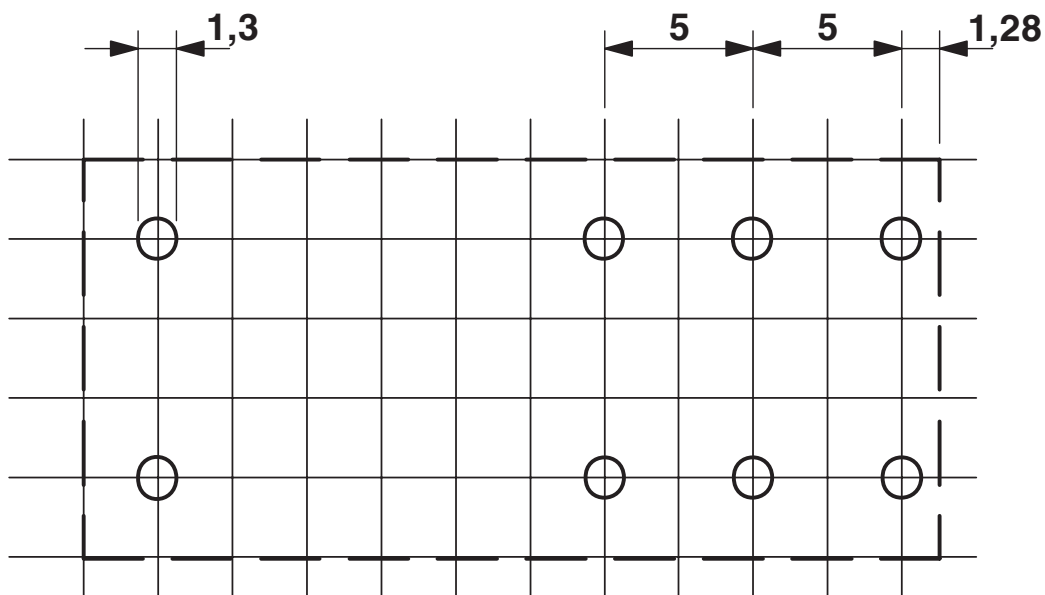

a = pitch division 2.5 mm

REL-MR- 12DC/21-21AU - Single relay



2961299

<https://www.phoenixcontact.com/ae/products/2961299>

Approvals

To download certificates, visit the product detail page: <https://www.phoenixcontact.com/ae/products/2961299>



cUL Recognized
Approval ID: FILE E 228652



UL Recognized
Approval ID: FILE E 228652



EAC
Approval ID: TR_TS_D_00573_c



UL Recognized
Approval ID: FILE E 228652



EAC
Approval ID: RU*C-DE.*08.B.00010



VDE Zeichengenehmigung
Approval ID: 40007758



VDE Zeichengenehmigung
Approval ID: 40048281



cUL Recognized
Approval ID: FILE E 228652

REL-MR- 12DC/21-21AU - Single relay



2961299

<https://www.phoenixcontact.com/ae/products/2961299>

Classifications

ECLASS

ECLASS-11.0	27371601
ECLASS-12.0	27371601
ECLASS-13.0	27371601

ETIM

ETIM 9.0	EC001437
----------	----------

UNSPSC

UNSPSC 21.0	39122300
-------------	----------

REL-MR- 12DC/21-21AU - Single relay



2961299

<https://www.phoenixcontact.com/ae/products/2961299>

Environmental product compliance

EU RoHS

Fulfills EU RoHS substance requirements	Yes, No exemptions
---	--------------------

China RoHS

Environment friendly use period (EFUP)	EFUP-E
	No hazardous substances above the limits

EU REACH SVHC

REACH candidate substance (CAS No.)	No substance above 0.1 wt%
-------------------------------------	----------------------------

Phoenix Contact 2024 © - all rights reserved
<https://www.phoenixcontact.com>

PHOENIX CONTACT Middle East FZ LLC
1201N-1206N, Dubai Science Park Towers – North
P.O. Box 345002, Dubai, United Arab Emirates
(+971) 4 437-0324
info-me@phoenixcontact.com