

RIF-2-RPT-LV-24AC/4X21 - Relay Module



2903306

<https://www.phoenixcontact.com/us/products/2903306>

Please be informed that the data shown in this PDF document is generated from our online catalog. Please find the complete data in the user documentation. Our general terms of use for downloads are valid.



Preassembled relay module with Push-in connection, consisting of: relay base, power contact relay, plug-in display/interference suppression module, and retaining bracket. Contact switching type: 4 changeover contacts. Input voltage: 24 V AC

Product description

The pluggable electromechanical and solid-state relays in the RIFLINE complete product range and the base are recognized and approved in accordance with UL 508. The relevant approvals can be called up at the individual components in question.

Commercial data

Item number	2903306
Packing unit	10 pc
Minimum order quantity	10 pc
Sales key	C465
Product key	CK652A
Catalog page	Page 341 (C-5-2019)
GTIN	4046356732147
Weight per piece (including packing)	106.45 g
Weight per piece (excluding packing)	106.45 g
Customs tariff number	85364110
Country of origin	CN

RIF-2-RPT-LV-24AC/4X21 - Relay Module



2903306

<https://www.phoenixcontact.com/us/products/2903306>

Set consists of

RIF-2-BPT/4X21 - Relay base

2900934

<https://www.phoenixcontact.com/us/products/2900934>



Relay base RIF-2..., for industrial relay with 2 or 4 changeover contacts, Push-in connection, plug-in option for input/interference suppression modules, for mounting on NS 35/7,5

REL-IR4/L- 24AC/4X21 - Single relay

2903686

<https://www.phoenixcontact.com/us/products/2903686>



Plug-in industrial relay with power contacts, 4 changeover contacts, test button, status LED, mechanical switching position indicator, coil voltage: 24 V AC

RIF-2-RPT-LV-24AC/4X21 - Relay Module



2903306

<https://www.phoenixcontact.com/us/products/2903306>

RIF-V-12-24 UC - Plug-in module

2900945

<https://www.phoenixcontact.com/us/products/2900945>



Plug-in module, for mounting on RIF-1, RIF-2, RIF-3, and RIF-4, with varistor, input voltage: 12 V AC ... 24 V AC / DC \pm 20 %

RIF-RH-2 - Retaining bracket

2900954

<https://www.phoenixcontact.com/us/products/2900954>



Relay retaining bracket, with ejector function and holder for marking material, suitable for RIF-2 relay base, for industrial relay

Technical data

Product properties

Product type	Relay Module
Product family	RIFLINE complete
Application	Universal
Operating mode	100% operating factor
Mechanical service life	approx. 2×10^7 cycles

Insulation characteristics

Insulation	Basic insulation
------------	------------------

Insulation characteristics

Insulation	Basic insulation
Overvoltage category	II
Pollution degree	2

Electrical properties

Maximum power dissipation for nominal condition	1.58 W
Test voltage (Winding/contact)	2.5 kV _{rms} (50 Hz, 1 min., winding/contact)
Test voltage (Contact/contact)	2 kV _{rms} (50 Hz, 1 min., contact/contact)
Rated insulation voltage	250 V AC
Rated surge voltage	2.5 kV

Input data

Coil side

Nominal input voltage U_N	24 V AC
Input voltage range	19.2 V AC ... 28.8 V AC (20 °C)
Input voltage range in reference to U_N	see diagram
Mains frequency	50/60 Hz
Drive and function	monostable
Drive (polarity)	polarized
Typical input current at U_N	66 mA
Typical response time	5 ms ... 15 ms
Typical release time range	5 ms ... 20 ms
Coil voltage	24 V AC
Protective circuit	Varistor
Operating voltage display	Yellow LED

Output data

Switching

Contact switching type	4 changeover contacts
Type of switch contact	Single contact

RIF-2-RPT-LV-24AC/4X21 - Relay Module



2903306

<https://www.phoenixcontact.com/us/products/2903306>

Contact material	AgNi
Maximum switching voltage	250 V AC/DC
Minimum switching voltage	5 V (At 24 mA)
Limiting continuous current	5 A (see diagram)
Maximum inrush current	16 A (20 ms, N/O contacts)
Min. switching current	5 mA (24 V)
Interrupting rating (ohmic load) max.	120 W (at 24 V DC)
	124 W (at 48 V DC)
	108 W (at 60 V DC)
	52 W (at 110 V DC)
	48 W (at 220 V DC)
	1250 VA (for 250 V AC)
Switching capacity	2 A (at 24 V, DC13)
	0.22 A (at 120 V, DC13)
	0.11 A (at 250 V, DC13)
	1.5 A (at 24 V, AC15)
	1.5 A (at 120 V, AC15)
	1 A (at 240 V, AC15)

Connection data

Connection method	Push-in connection
Stripping length	8 mm
Conductor cross section rigid	0.14 mm ² ... 1.5 mm ²
Conductor cross section flexible	0.14 mm ² ... 1.5 mm ²
	0.14 mm ² ... 1.5 mm ² (Ferrule with plastic sleeve)
	0.14 mm ² ... 1 mm ² (Ferrule with plastic sleeve, two conductors on double terminal block)
Conductor cross section AWG	26 ... 16 (solid)
	26 ... 16 (flexible)

Dimensions

Drill hole

Diameter	3.2 mm
Width	31 mm
Height	96 mm
Depth	75 mm

Material specifications

Color	gray (RAL 7042)
Flammability rating according to UL 94	V2 (Housing)

Environmental and real-life conditions

Ambient conditions

Degree of protection (Relay base)	IP20 (Relay base)
-----------------------------------	-------------------

RIF-2-RPT-LV-24AC/4X21 - Relay Module



2903306

<https://www.phoenixcontact.com/us/products/2903306>

Degree of protection (Relay)	RT I (Relay)
Ambient temperature (operation)	-40 °C ... 50 °C
Ambient temperature (storage/transport)	-40 °C ... 85 °C

Approvals

Corrosive gas test

Identification	ISA-S71.04. G3 Harsh Group
	EN 60068-2-60

Standards and regulations

Standards/regulations	IEC 60947-5-1
-----------------------	---------------

Mounting

Mounting type	DIN rail mounting
Assembly instructions	in rows with zero spacing
Mounting position	any

Drawings

Diagram

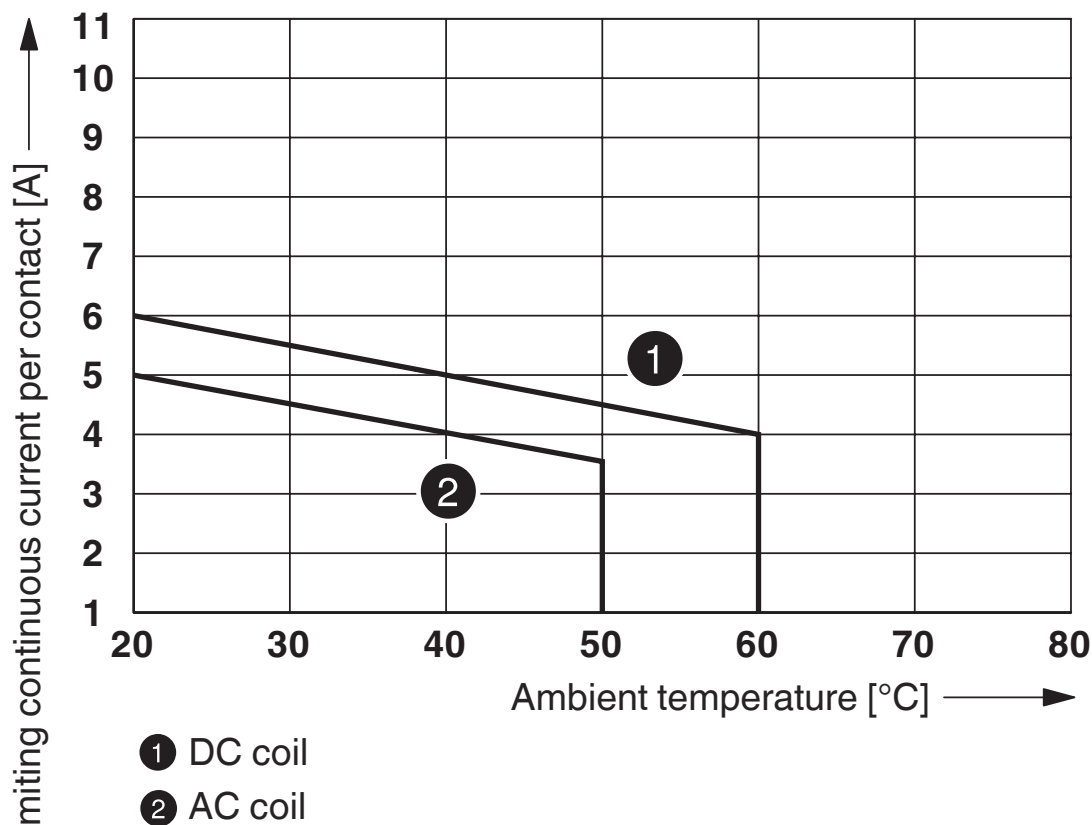

Contact derating

RIF-2-RPT-LV-24AC/4X21 - Relay Module



2903306

<https://www.phoenixcontact.com/us/products/2903306>

Circuit diagram

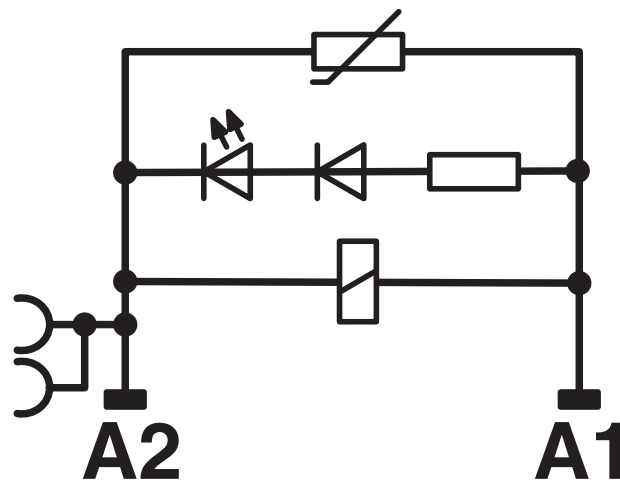
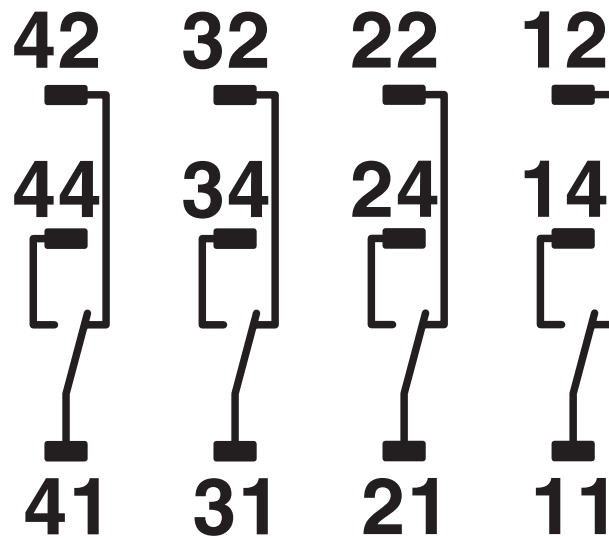

Diagram

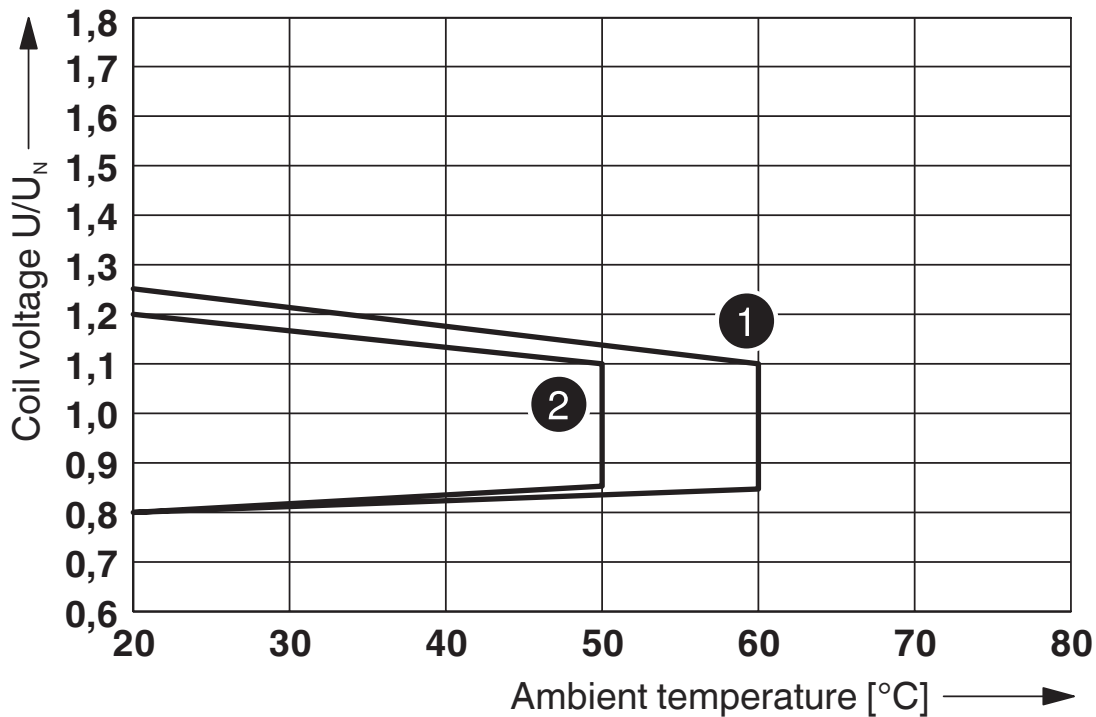

- ① DC coil (observe contact derating)
- ② AC coil (observe contact derating)

Operating voltage range

Diagram

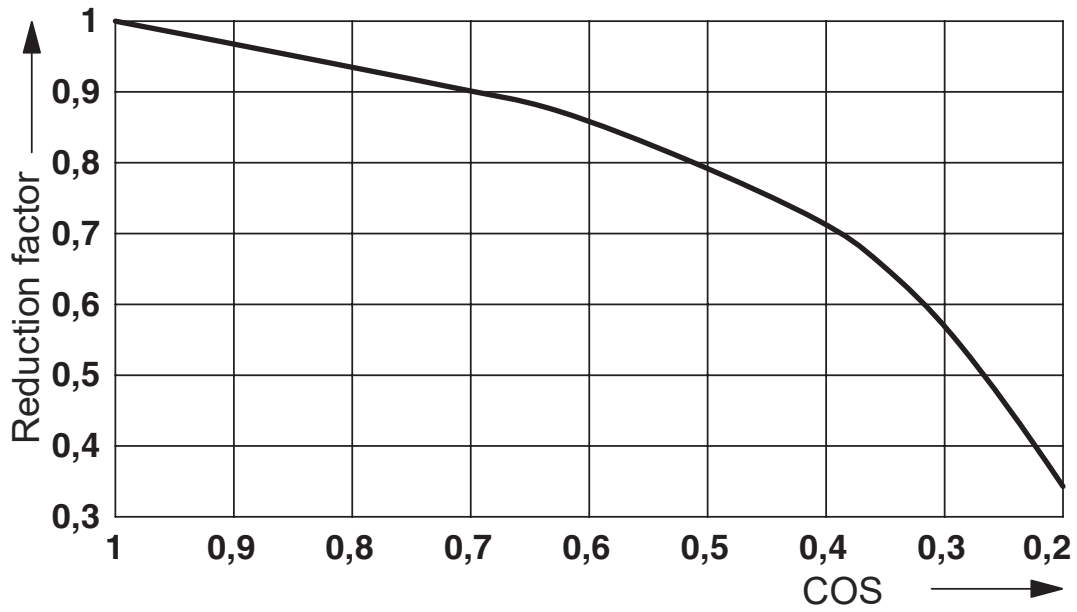

Service life reduction factor

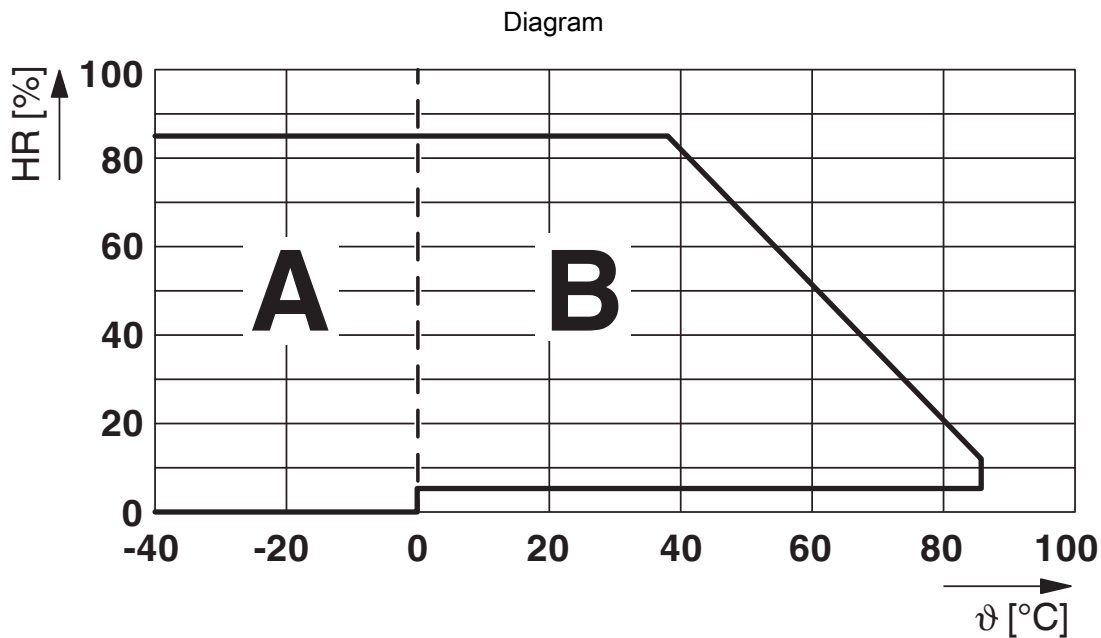

Permissible humidity for operation and storage.

The maximum permissible ambient temperature as specified in the data sheet must be observed.

Area A: Ice buildup at ambient temperatures $\leq 0^{\circ}\text{C}$ must be prevented

Area B: Condensation at ambient temperatures $> 0^{\circ}\text{C}$ must be prevented

On 30 full days that are naturally distributed across an entire year, a humidity level of 95% is permissible at an ambient temperature $\leq 25^{\circ}\text{C}$.

RIF-2-RPT-LV-24AC/4X21 - Relay Module



2903306

<https://www.phoenixcontact.com/us/products/2903306>

Diagram

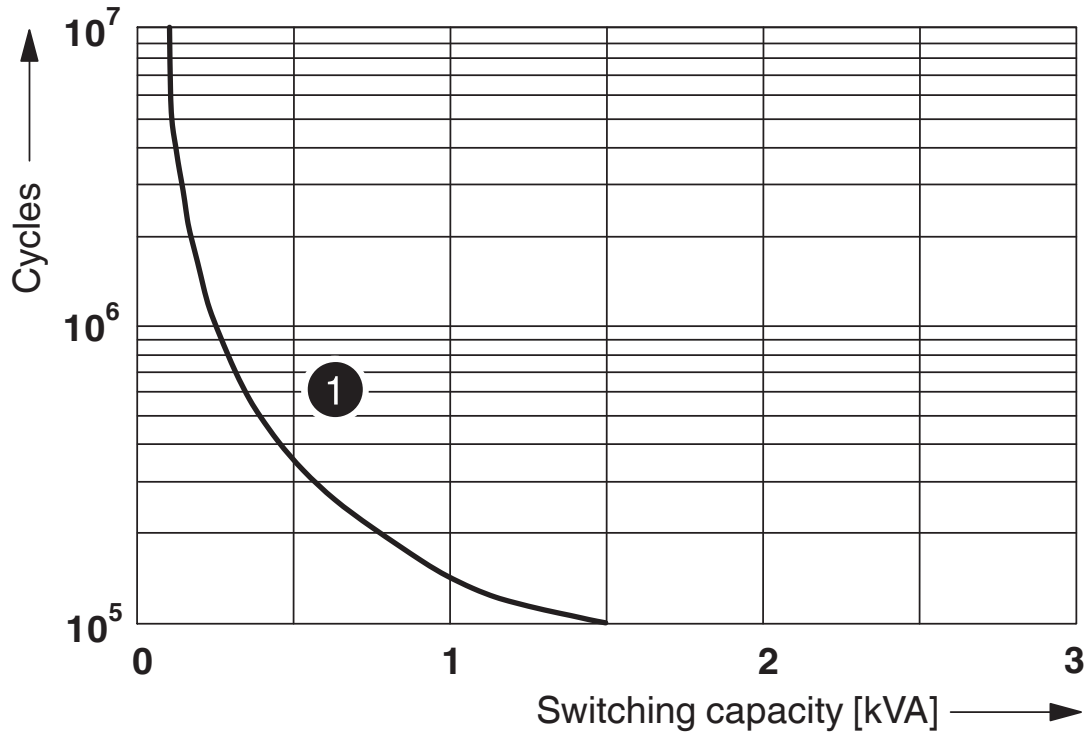

① 250 V AC, Ohmic load

Electrical service life

RIF-2-RPT-LV-24AC/4X21 - Relay Module



2903306

<https://www.phoenixcontact.com/us/products/2903306>

Diagram

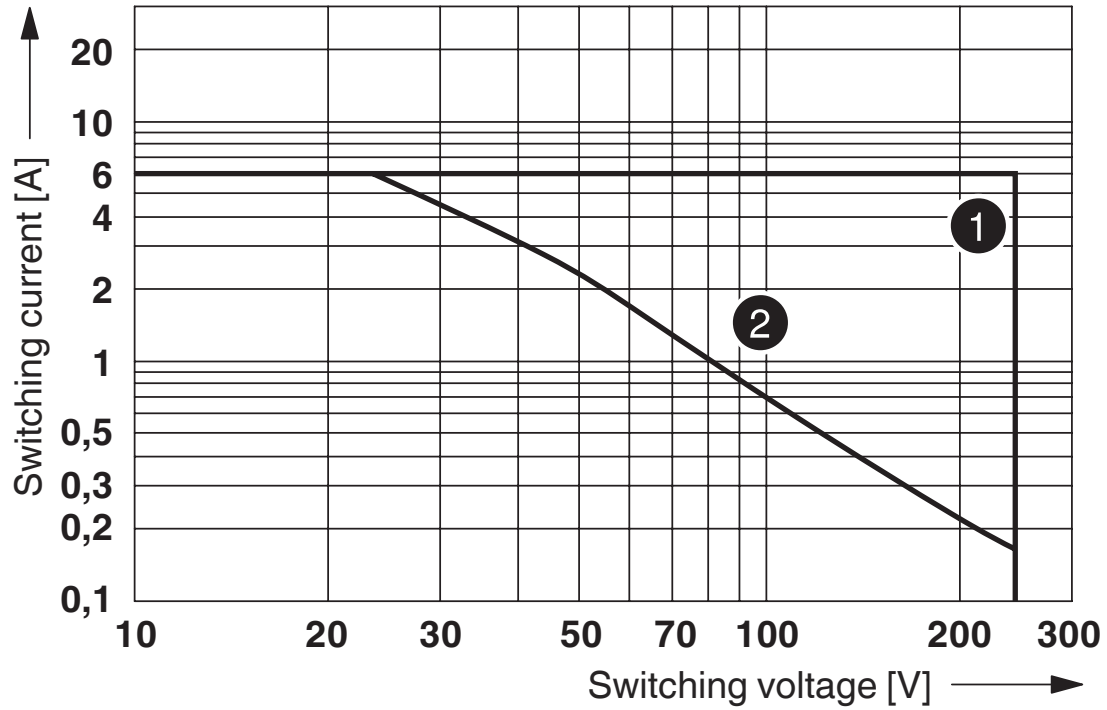

- ① AC, ohmic load
- ② DC, ohmic load

Interrupting rating

RIF-2-RPT-LV-24AC/4X21 - Relay Module



2903306

<https://www.phoenixcontact.com/us/products/2903306>

Approvals

To download certificates, visit the product detail page: <https://www.phoenixcontact.com/us/products/2903306>



CSA

Approval ID: 76787



EAC

Approval ID: TR_TS_D_00573_c



DNV GL

Approval ID: TAA000018V

RIF-2-RPT-LV-24AC/4X21 - Relay Module



2903306

<https://www.phoenixcontact.com/us/products/2903306>

Classifications

ECLASS

ECLASS-11.0	27371601
ECLASS-12.0	27371601
ECLASS-13.0	27371601

ETIM

ETIM 9.0	EC001437
----------	----------

UNSPSC

UNSPSC 21.0	39122300
-------------	----------

RIF-2-RPT-LV-24AC/4X21 - Relay Module



2903306

<https://www.phoenixcontact.com/us/products/2903306>

Environmental product compliance

China RoHS	Environmentally friendly use period: unlimited = EFUP-e
	No hazardous substances above threshold values

Phoenix Contact 2024 © - all rights reserved
<https://www.phoenixcontact.com>

Phoenix Contact USA
586 Fulling Mill Road
Middletown, PA 17057, United States
(+717) 944-1300
info@phoenixcon.com