

RIF-3-RPT-LDP-24DC/2X21 - Relay Module



2903297

<https://www.phoenixcontact.com/us/products/2903297>

Please be informed that the data shown in this PDF document is generated from our online catalog. Please find the complete data in the user documentation. Our general terms of use for downloads are valid.



Preassembled relay module with Push-in connection, consisting of: relay base, power contact relay, and retaining bracket. Contact switching type: 2 changeover contacts. Input voltage: 24 V DC

Product description

The pluggable electromechanical and solid-state relays in the RIFLINE complete product range and the base are recognized and approved in accordance with UL 508. The relevant approvals can be called up at the individual components in question.

Commercial data

Item number	2903297
Packing unit	1 pc
Sales key	C465
Product key	CK652B
Catalog page	Page 346 (C-5-2019)
GTIN	4046356732017
Weight per piece (including packing)	163.8 g
Weight per piece (excluding packing)	163.8 g
Customs tariff number	85364110
Country of origin	DE

RIF-3-RPT-LDP-24DC/2X21 - Relay Module



2903297

<https://www.phoenixcontact.com/us/products/2903297>

Set consists of

RIF-3-BPT/2X21 - Relay base

2900937

<https://www.phoenixcontact.com/us/products/2900937>



Relay base RIF-3..., for octal relays with 2 changeover contacts, Push-in connection, plug-in option for input/interference suppression modules, for mounting on NS 35/7,5

REL-OR2/LDP- 24DC/2X21 - Single relay

2903689

<https://www.phoenixcontact.com/us/products/2903689>



Plug-in octal relays with power contacts, 2 changeover contacts, test button, freewheeling diode, mechanical switching position indicator, polarity: A1+, A2-, coil voltage: 24 V DC

RIF-3-RPT-LDP-24DC/2X21 - Relay Module



2903297

<https://www.phoenixcontact.com/us/products/2903297>

RIF-RH-3 - Retaining bracket

2900955

<https://www.phoenixcontact.com/us/products/2900955>



Relay retaining bracket, with holder for marking material, suitable for RIF-3 relay base, for octal relay

RIF-3-RPT-LDP-24DC/2X21 - Relay Module



2903297

<https://www.phoenixcontact.com/us/products/2903297>

Technical data

Product properties

Product type	Relay Module
Product family	RIFLINE complete
Application	Universal
Operating mode	100% operating factor
Mechanical service life	approx. 2×10^7 cycles

Insulation characteristics

Insulation	Basic insulation
------------	------------------

Insulation characteristics

Insulation	Basic insulation
Overvoltage category	III
Pollution degree	2

Electrical properties

Maximum power dissipation for nominal condition	1.44 W
Test voltage (Winding/contact)	2.5 kV _{rms} (50 Hz, 1 min., winding/contact)
Test voltage (Contact/contact)	2 kV _{rms} (50 Hz, 1 min., contact/contact)
Rated insulation voltage	250 V AC
Rated surge voltage	4 kV

Input data

Coil side

Nominal input voltage U_N	24 V DC
Input voltage range	20.4 V DC ... 26.4 V DC (20 °C)
Input voltage range in reference to U_N	see diagram
Drive and function	monostable
Typical input current at U_N	60 mA
Typical response time	18 ms
Typical release time	20 ms
Coil voltage	24 V DC
Protective circuit	Freewheeling diode
Operating voltage display	Yellow LED

Output data

Switching

Contact switching type	2 changeover contacts
Type of switch contact	Single contact
Contact material	AgNi
Maximum switching voltage	250 V AC/DC

RIF-3-RPT-LDP-24DC/2X21 - Relay Module



2903297

<https://www.phoenixcontact.com/us/products/2903297>

Minimum switching voltage	10 V (24 mA)
Limiting continuous current	10 A (see diagram)
Maximum inrush current	30 A (20 ms, N/O contacts)
Min. switching current	10 mA (24 V)
Interrupting rating (ohmic load) max.	240 W (24 V DC)
	124 W (48 V DC)
	108 W (60 V DC)
	52 W (110 V DC)
	48 W (220 V DC)
	2500 VA (250 V AC)
Utilization category CB Scheme (IEC 60947-5-1)	AC15, 1.5 A/240 V (N/O contact)
	DC13, 2 A/240 V (N/O contact)

Connection data

Connection method	Push-in connection
Stripping length	8 mm
Conductor cross section rigid	0.14 mm ² ... 1.5 mm ²
Conductor cross section flexible	0.14 mm ² ... 1.5 mm ²
	0.14 mm ² ... 1.5 mm ² (Ferrule with plastic sleeve)
	0.14 mm ² ... 1 mm ² (Ferrule with plastic sleeve, two conductors on double terminal block)
Conductor cross section AWG	26 ... 16 (solid)
	26 ... 16 (flexible)

Dimensions

Drill hole

Diameter	3.2 mm
Width	40 mm
Height	103 mm
Depth	90 mm

Material specifications

Color	gray (RAL 7042)
Flammability rating according to UL 94	V2 (Housing)

Environmental and real-life conditions

Ambient conditions

Degree of protection (Relay base)	IP20 (Relay base)
Degree of protection (Relay)	RT I (Relay)
Ambient temperature (operation)	-40 °C ... 60 °C
Ambient temperature (storage/transport)	-40 °C ... 85 °C

Approvals

RIF-3-RPT-LDP-24DC/2X21 - Relay Module



2903297

<https://www.phoenixcontact.com/us/products/2903297>

Corrosive gas test

Identification	ISA-S71.04. G3 Harsh Group
	EN 60068-2-60

Standards and regulations

Standards/regulations	DIN EN 50178
-----------------------	--------------

Mounting

Mounting type	DIN rail mounting
Assembly instructions	in rows with zero spacing
Mounting position	any

Drawings

Diagram

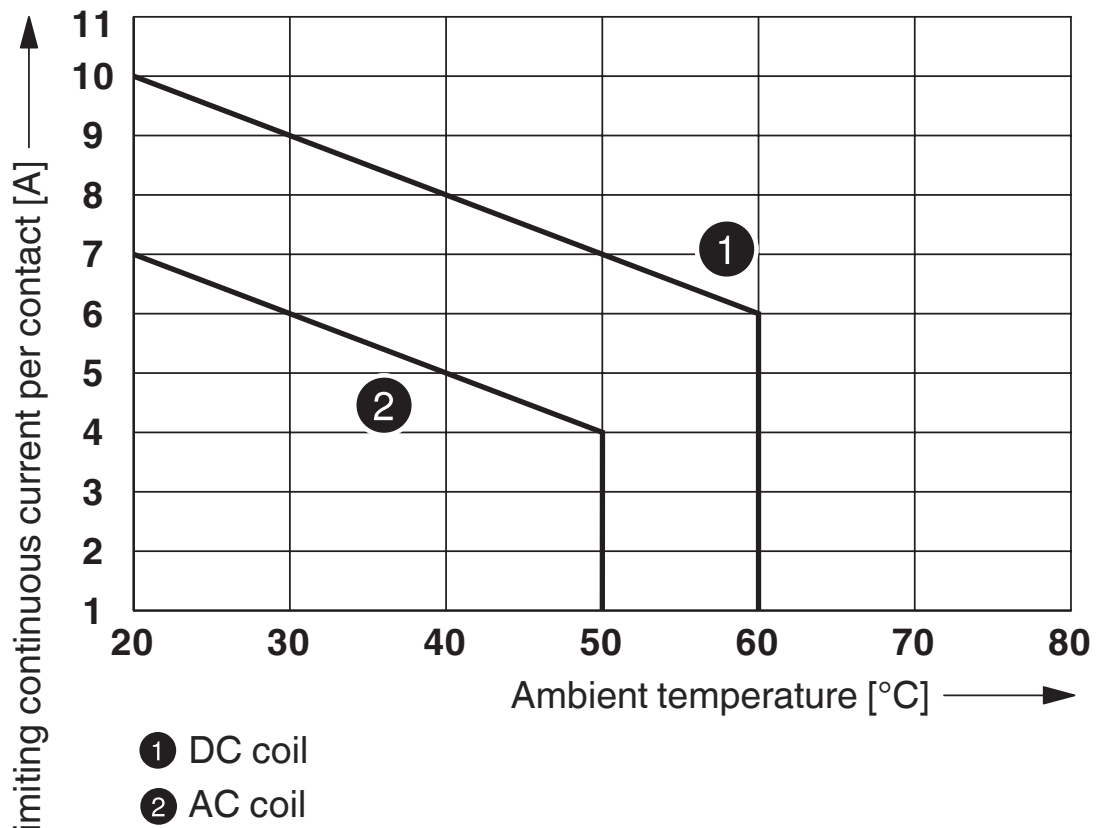

Contact derating

Diagram

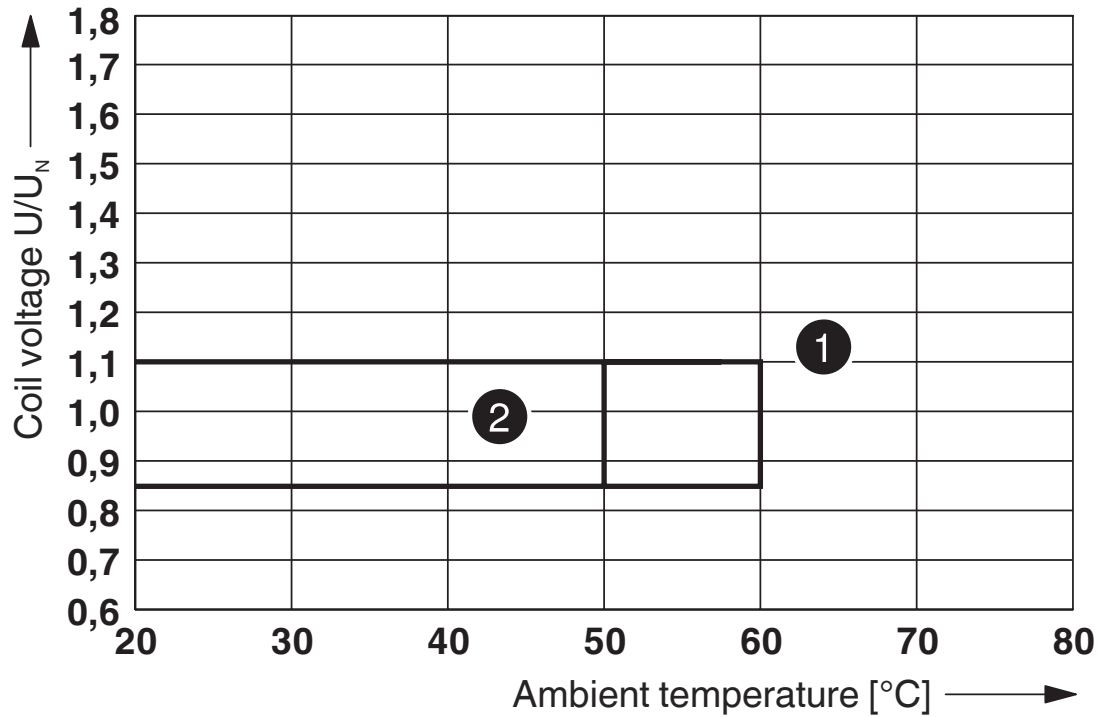

- ① DC coil (observe contact derating)
- ② AC coil (observe contact derating)

Operating voltage range

Diagram

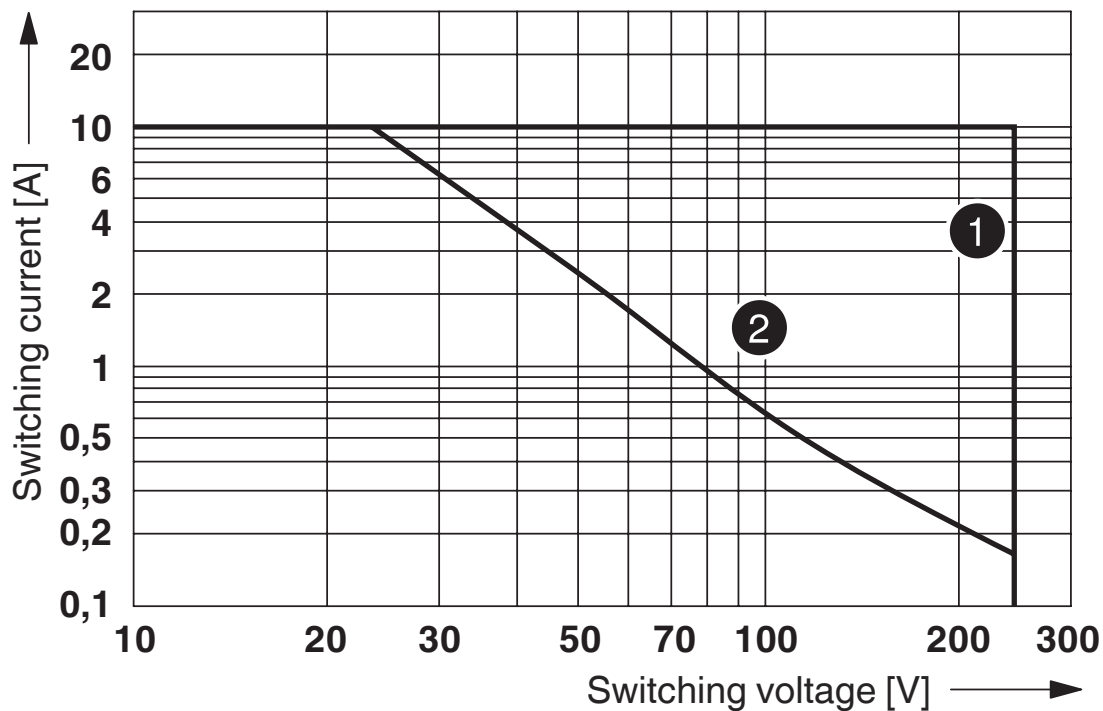

- ① AC, ohmic load
- ② DC, ohmic load

Interrupting rating

Diagram

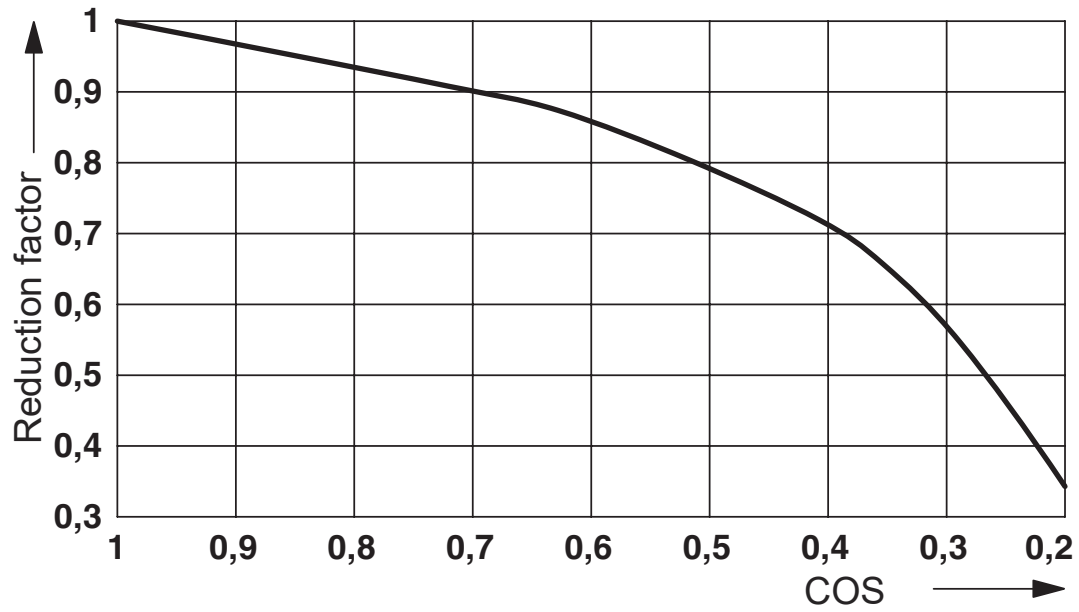

Service life reduction factor

RIF-3-RPT-LDP-24DC/2X21 - Relay Module



2903297

<https://www.phoenixcontact.com/us/products/2903297>

Circuit diagram

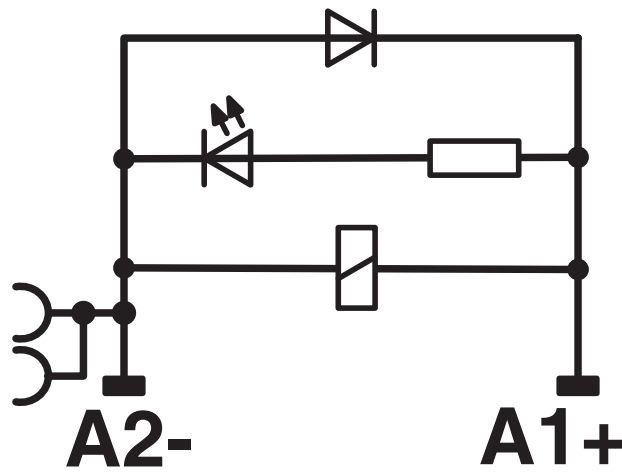
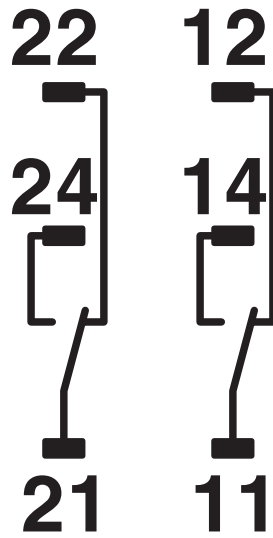

RIF-3-RPT-LDP-24DC/2X21 - Relay Module



2903297

<https://www.phoenixcontact.com/us/products/2903297>

Diagram

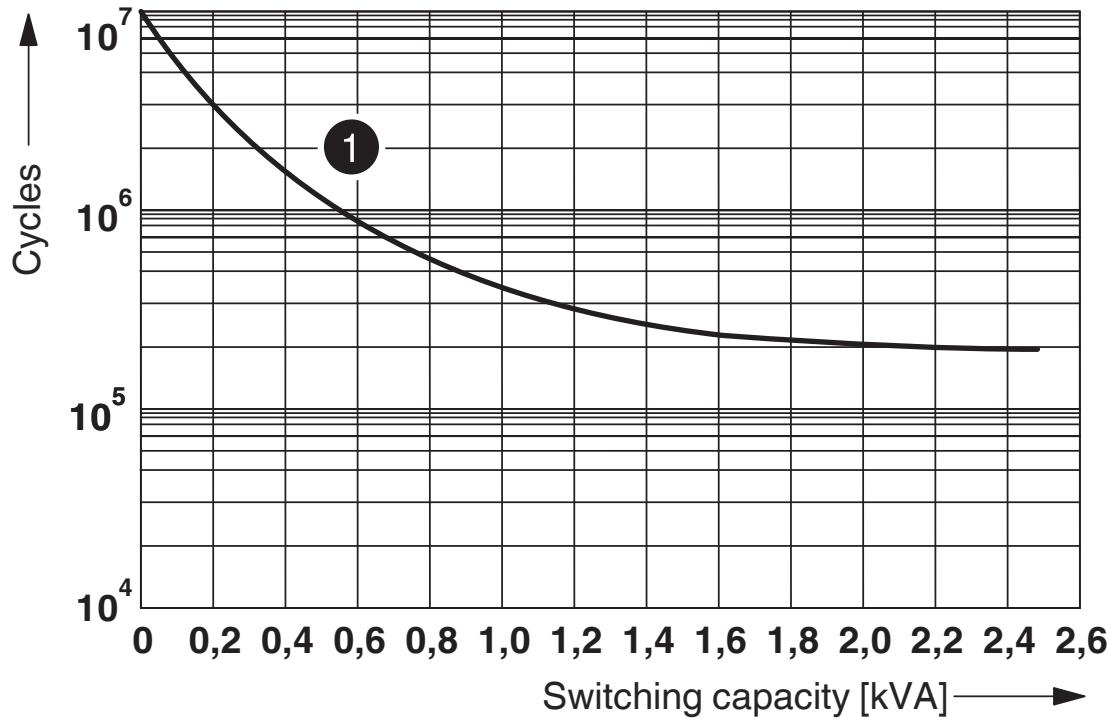

250 V AC, ohmic load

Electrical service life

RIF-3-RPT-LDP-24DC/2X21 - Relay Module



2903297

<https://www.phoenixcontact.com/us/products/2903297>

Classifications

ECLASS

ECLASS-11.0

27371601

ETIM

ETIM 8.0

EC001437

UNSPSC

UNSPSC 21.0

39122300

RIF-3-RPT-LDP-24DC/2X21 - Relay Module



2903297

<https://www.phoenixcontact.com/us/products/2903297>

Environmental product compliance

China RoHS	Environmentally friendly use period: unlimited = EFUP-e
	No hazardous substances above threshold values

Phoenix Contact 2024 © - all rights reserved
<https://www.phoenixcontact.com>

Phoenix Contact USA
586 Fulling Mill Road
Middletown, PA 17057, United States
(+717) 944-1300
info@phoenixcon.com