



Contactor, 75kW/400V, AC operated

Part no.

DILM150(RAC440)

Article no.

239589



Delivery programme

Product range			Contactors
Application			Contactors for Motors
Subrange			Contactors up to 170 A, 3 pole
Connection technique			Screw terminals
Rated operational current			
AC-3			
380 V 400 V	I_e	A	150
AC-1			
Conventional free air thermal current, 3 pole, 50 - 60 Hz			
Open			
at 60 °C	$I_{th} = I_e$	A	160
Max. rating for three-phase motors, 50 - 60 Hz			
AC-3			
220 V 230 V	P	kW	48
380 V 400 V	P	kW	75
660 V 690 V	P	kW	96
AC-4			
220 V 230 V	P	kW	20
380 V 400 V	P	kW	33
660 V 690 V	P	kW	48
Contact sequence			
Can be combined with auxiliary contact			DILM150-XHI(V).. DILM1000-XHI(V)..
Voltage AC/DC			AC operation

Approbationen

Product Standards
UL File No.
UL CCN
CSA File No.
CSA Class No.
NA Certification
Specially designed for NA

IEC/EN 60947-4-1; UL 508; CSA-C22.2 No. 14-05; CE marking
E29096
NLDX
012528
2411-03, 3211-04
UL Listed, CSA certified
No

General

Standards			IEC/EN 60947, VDE 0660, UL, CSA
Lifespan, mechanical			
AC operated	Operations	$\times 10^6$	10
DC operated	Operations	$\times 10^6$	10
Operating frequency, mechanical			
AC operated	Operations/h		3600
DC operated	Operations/h		3600
Climatic proofing			Damp heat, constant to IEC 60068-2-78 Damp heat, cyclic to IEC 60068-2-30
Ambient temperature		°C	
Open		°C	- 25 - 60
Enclosed		°C	- 25 - 40

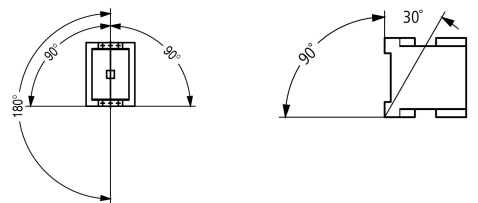
Storage		°C	- 40 - 80
Mounting position, AC- and DC operated			
Mechanical shock resistance (IEC/EN 60068-2-27)			
Half-sinusoidal shock, 10 ms			
Main contacts			
N/O contact		g	10
Auxiliary contacts			
N/O contact		g	7
N/C contact		g	5
Mechanical shock resistance (IEC/EN 60068-2-27) when tabletop-mounted			
Half-sinusoidal shock, 10 ms			
Main contacts			
N/O contact		g	10
Auxiliary contacts			
N/O contact		g	7
N/C contact		g	5
Protection type			IP00
Protection against direct contact when actuated from front (EN 90274)			Finger- and back-of-hand proof
Weight			
AC operated		kg	2
DC operated		kg	2.1
Terminal capacity main cable			
Flexible with ferrule		mm ²	1 x (10 - 95) 2 x (10 - 70)
Stranded		mm ²	1 x (16 - 95) 2 x (16 - 70)
Solid or stranded		AWG	8...3/0
Flat conductor	Number of segments x width x thickness	mm	2 x (6 x 16 x 0.8)
Main cable connection screw/bolt			M10
Tightening torque		Nm	14
Terminal capacity control circuit cables			
Solid		mm ²	1 x (0.75 - 4) 2 x (0.75 - 4)
Flexible with ferrule		mm ²	1 x (0.75 - 2.5) 2 x (0.75 - 2.5)
Solid or stranded		AWG	18 - 14
Control circuit cable connection screw/bolt			M3.5
Tightening torque		Nm	1.2
Tool			
Main cable			
Hexagon socket-head spanner	SW	mm	5
Control circuit cables			
Pozidriv screwdriver		Size	2
Standard screwdriver		mm	0.8 x 5.5 1 x 6
Terminal capacity control circuit cables			
Solid		mm ²	1 x (0.75 - 2.5) 2 x (0.75 - 2.5)
Flexible		mm ²	1 x (0.75 - 2.5) 2 x (0.75 - 2.5)
Flexible with ferrule		mm ²	1 x (0.75 - 1.5) 2 x (0.75 - 1.5)
Solid or stranded		AWG	18 - 14

Tool			
Stripping length		mm	10
Screwdriver blade width		mm	3.5

Main conducting paths

Rated impulse withstand voltage	U_{imp}	V AC	8000
Overvoltage category/pollution degree			III/3
Rated insulation voltage	U_i	V AC	690
Rated operational voltage	U_e	V AC	690
Safe isolation to VDE 0106 Part 101 and Part 101/A1			
between coil and contacts		V AC	690
between the contacts		V AC	690
Making capacity (p.f. to IEC/EN 60947)			
	U_p to 690 V	A	2100
Breaking capacity			
220/230 V		A	1500
380/400 V		A	1500
500 V		A	1500
660/690 V		A	1200
Short-circuit rating			
Short-circuit protection maximum fuse			
Type "2" coordination			
400 V	gG/gL 500 V	A	250
690 V	gG/gL 690 V	A	250
Type "1" coordination			
400 V	gG/gL 500 V	A	250
690 V	gG/gL 690 V	A	250

AC

AC-1 duty			
Conventional free air thermal current, 3 pole, 50 - 60 Hz			
Open			
at 40 °C	$I_{th} = I_e$	A	190
at 50 °C	$I_{th} = I_e$	A	180
at 55 °C	$I_{th} = I_e$	A	170
at 60 °C	$I_{th} = I_e$	A	160
enclosed	I_{th}	A	144
Conventional free air thermal current, 1 pole			
open	I_{th}	A	400
enclosed	I_{th}	A	360
AC-3 duty			
Rated operational current AC-3 open, 50 - 60 Hz, 3 pole	I_e		
220/230 V	I_e	A	150
240 V	I_e	A	150
380/400 V	I_e	A	150
415 V	I_e	A	150
440V	I_e	A	150
500 V	I_e	A	150
660/690 V	I_e	A	100
Motor rating	P	kWh	
220/230 V	P	kW	48
240V	P	kW	52
380/400 V	P	kW	75
415 V	P	kW	91
440 V	P	kW	95
500 V	P	kW	110

660/690 V	P	kW	96
AC-4 duty			
Rated operational current AC-4 open, 50 - 60 Hz, 3 pole			
220/230 V	I_e	A	65
240 V	I_e	A	65
380/400 V	I_e	A	65
415 V	I_e	A	65
440 V	I_e	A	65
500 V	I_e	A	65
660/690 V	I_e	A	50
Motor rating			
220/230 V	P	kW	20
240 V	P	kW	22
380/400 V	P	kW	33
415 V	P	kW	39
440 V	P	kW	41
500 V	P	kW	47
660/690 V	P	kW	48

DC

Rated operational current, open			
DC-1 operation			
60 V	I_e	A	160
110 V	I_e	A	160
220 V	I_e	A	90
440 V	I_e	A	4.5
DC-3 operation			
60 V	I_e	A	160
110 V	I_e	A	160
220 V	I_e	A	40
440 V	I_e	A	1
DC-5 operation			
60 V	I_e	A	160
110 V	I_e	A	160
220 V	I_e	A	40
440 V	I_e	A	1

Current heat loss (3 pole)

Current heat loss at I_{th}		W	30.7
Current heat loss at I_e to AC-3/400 V		W	27
Impedance per pole		m Ω	0.4

Magnet systems

Voltage tolerance			
AC operated	Pick-up	$x U_c$	0.8 - 1.15
Drop-out voltage AC operated	Drop-out	$x U_c$	0.25 - 0.6
DC operated	Pick-up	$x U_c$	0.7 - 1.2
Notes			at least smoothed two-phase bridge rectifier or three-phase rectifier
DC operated	Drop-out	$x U_c$	0.15 - 0.6
Power consumption of the coil in a cold state and $1.0 \times U_c$			
50 Hz	Pick-up	VA	180
50 Hz	Sealing	VA	3.1
50 Hz	Sealing	W	2.1
60 Hz	Pick-up	VA	170
60 Hz	Sealing	VA	3.1
60 Hz	Sealing	W	2.1
50/60 Hz	Pick-up	VA	170

			170
50/60 Hz	Sealing	VA	3.1 3.1
50/60 Hz	Sealing	W	2.1 2.1
DC operated	Pick-up	W	149
DC operated	Sealing	W	2.1
Duty factor		% DF	100
Switching times at 100 % U _c (approximate values)			
Main contacts			
AC operated			
	Closing delay	ms	28 - 33
	Opening delay	ms	35 - 41
DC operated			
	Closing delay	ms	35
	Opening delay	ms	30
	Arcing time	ms	15
	Permissible residual current with actuation of A1 - A2 by the electronics (with 0 signal).	mA	≤ 1
Lifespan, mechanical; Coil 50/60 Hz	at 50 Hz		Mechanical lifespan at 50 Hz approx. 30% lower than under "Technical data, general"

Electromagnetic compatibility (EMC)

Emitted interference			to EN 60947-1
Interference immunity			to EN 60947-1

Technische Daten nach ETIM 4.0

Number of main contacts as N/Os			3
Rated operation current I _e at AC-1, 400 V			190
Connection type main circuit			Screw connection
Rated control voltage U _s at AC 60HZ		V	440
Number of auxiliary contacts as N/Os			0
Rated control voltage U _s at AC 50HZ		V	440
Number of auxiliary contacts as N/Cs			0
Suitable for rail-mounting			No
Rated control voltage U _s at DC		V	0
Voltage type for actuation			AC
Rated operation current I _e at AC-3, 400 V		A	150
Number of N/Cs as main contact			0
Motor rating at AC-3, 400 V		kWh	75

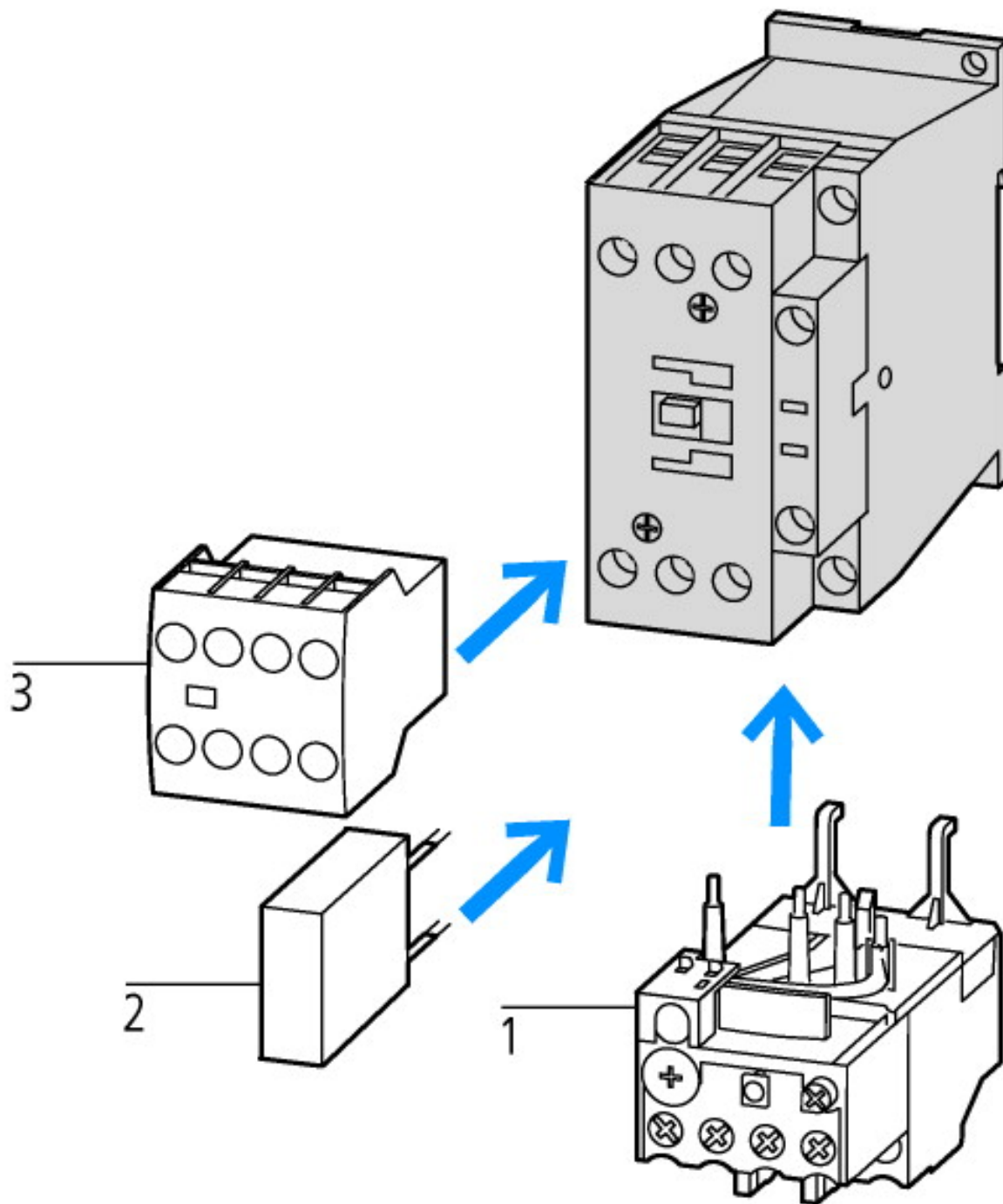

- 1: Overload relay
- 2: Suppressor
- 3: Auxiliary contact modules

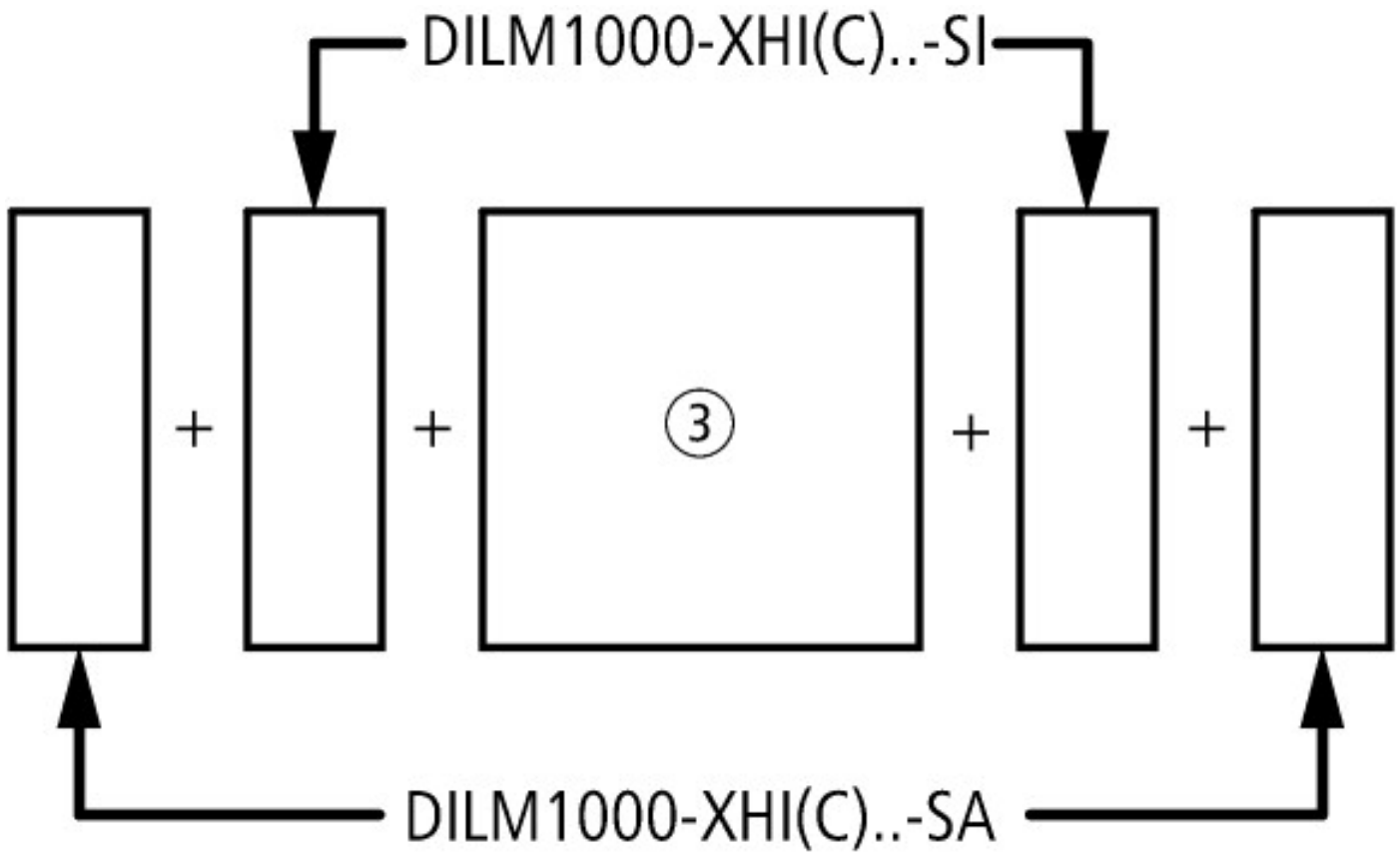

on the side: 2 x DILM820-XHI(V)11-SI; 2 x DILM820-XHI(V)11-SA
 on the side: 2 x DILM1000-XHI(V)11-SI; surface mounting: 1 x DILM150-XHIA22
 on the side: 2 x DILM1000-XHI(V)11-SI; surface mounting: 1 x DILM150-XHIA11
 on the side: 2 x DILM1000-XHI(V)11-SA; surface mounting: 1 x DILM150-XHI (4 pole)
 on the side: 2 x DILM1000-XHI(V)11-SA; surface mounting: 1 x DILM150-XHI (2 pole)

Projektieren

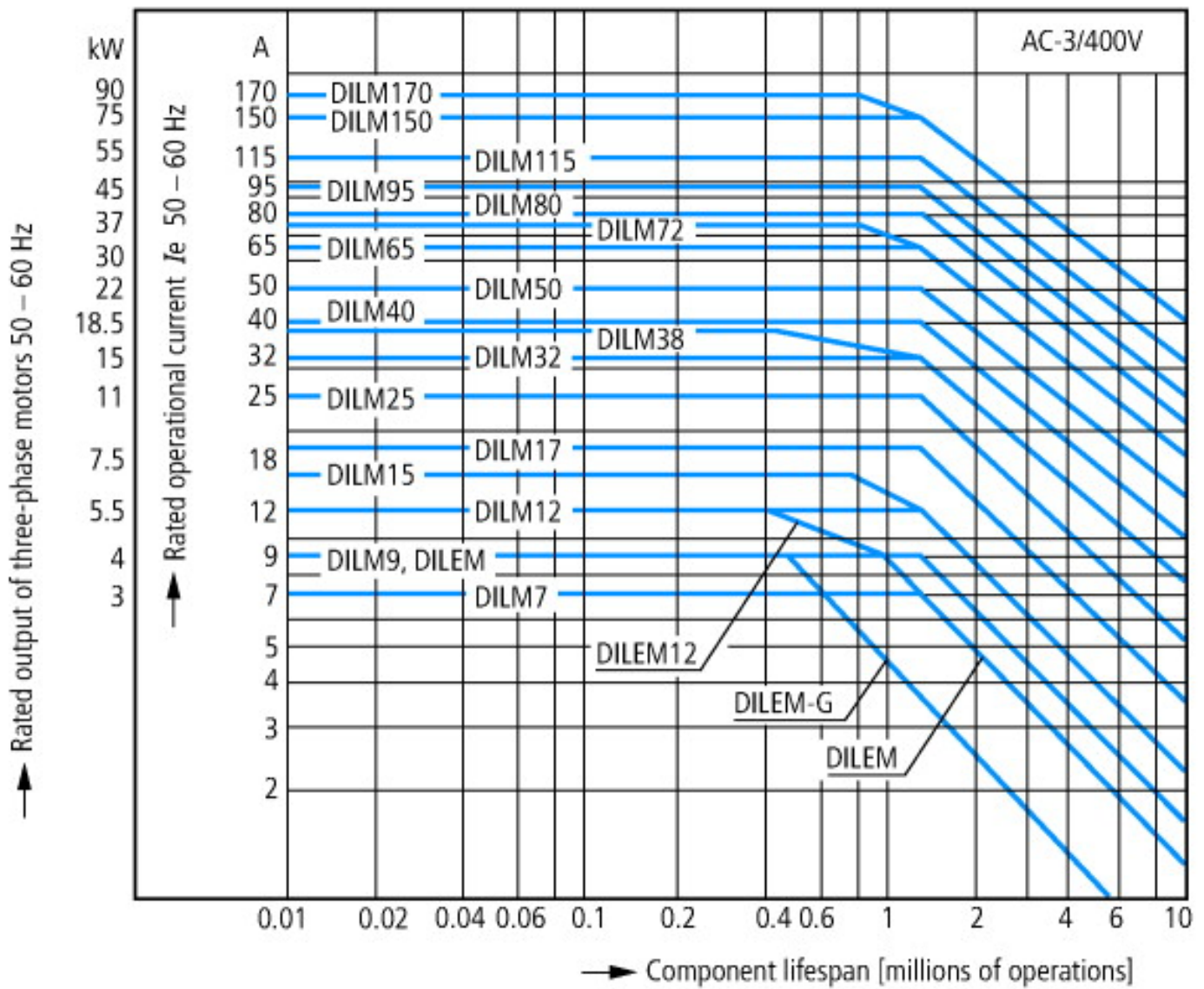

- Squirrel-cage motor
- Operating characteristics
- Starting: from rest
- Stopping: after attaining full running speed
- Electrical characteristics
- Make: up to 6 x rated motor current
- Break: up to 1 x rated motor current
- Utilization category
- 100 % AC-3
- Typical applications
- Compressors
- Lifts
- Mixers
- Pumps
- Escalators
- Agitators
- Fans
- Conveyor belts
- Centrifuges
- Hinged flaps
- Bucket-elevators
- Air conditioning system
- General drives in manufacturing and processing machines

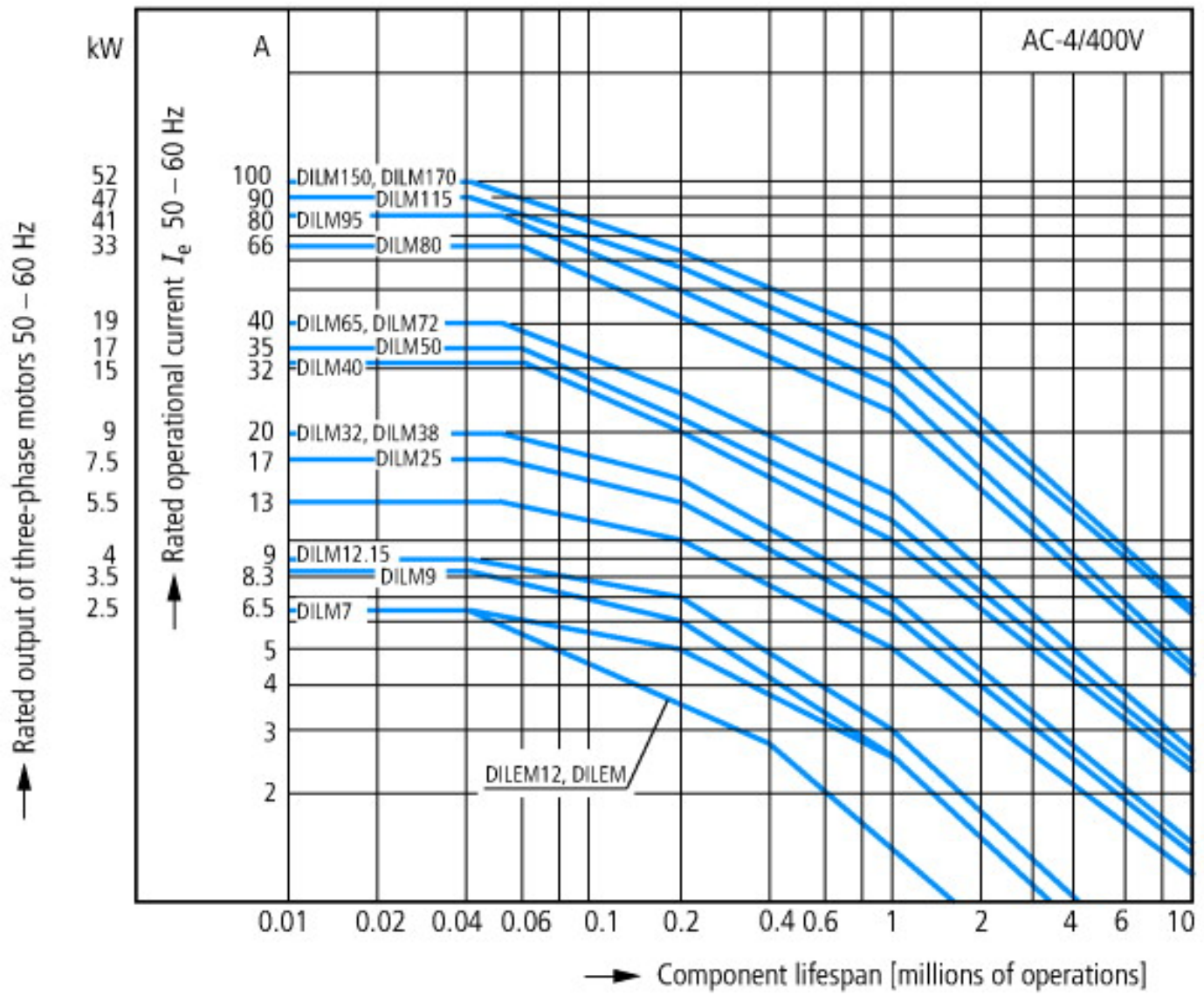

- Extreme switching duty
- Squirrel-cage motor
- Operating characteristics
- Inching, plugging, reversing
- Electrical characteristics
- Make: up to 6 x rated motor current
- Break: up to 6 x rated motor current
- Utilization category
- 100 % AC-4
- Typical applications
- Printing presses
- Wire-drawing machines
- Centrifuges
- Special drives for manufacturing and processing machines

CAD-Daten

Product standards CAD data:

<http://eaton-moeller.partcommunity.com>

Dimensions

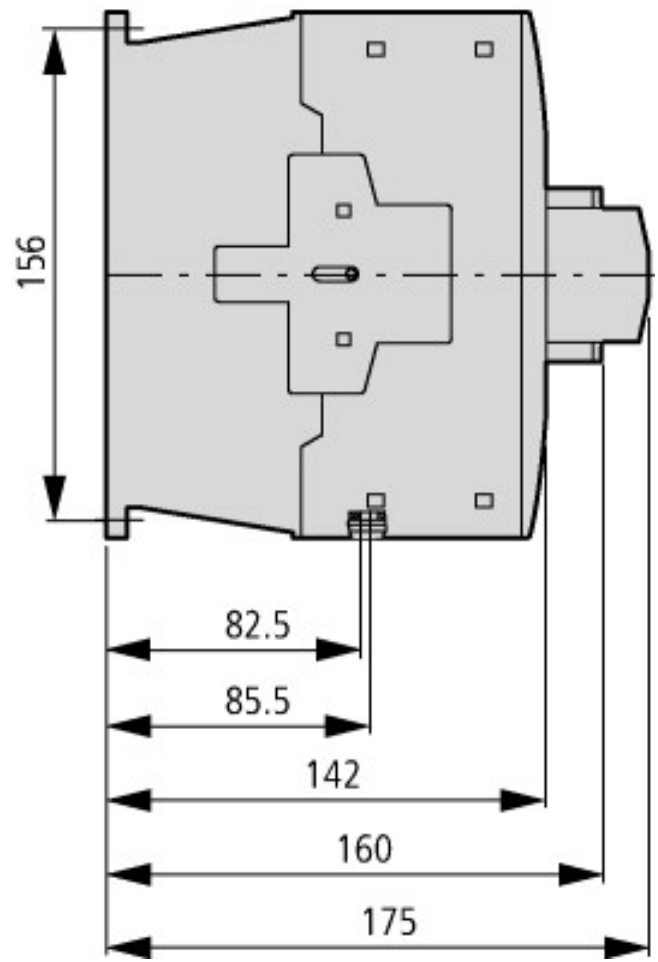
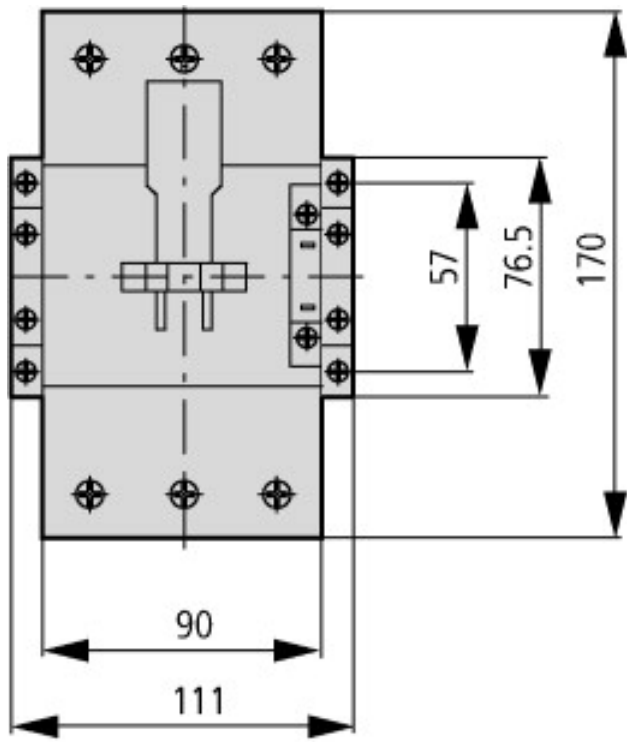

Contacteur with auxiliary contact module

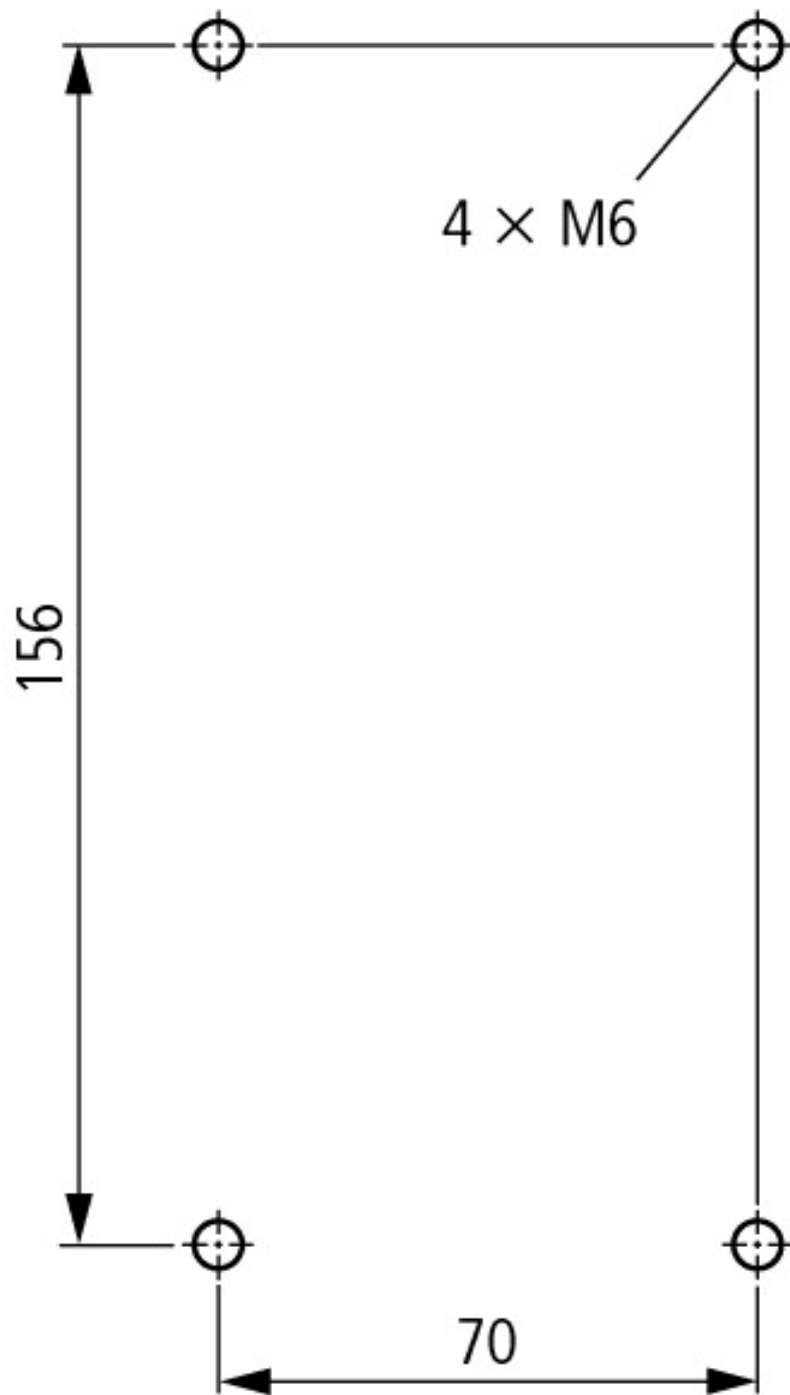

distance at side to earthed parts: 10 mm

DILM80...DILM170
DILMC80...DILMC150
DILMF80...DILMF150

Additional product information (links)

AWA2100-2286 (IL03407039Z) contactor DILM

ftp://ftp.moeller.net/DOCUMENTATION/AWA_INSTRUCTIONS/22860209.pdf