

FK-MC 0,5/ 4-ST-2,5 - PCB connector



1881341

<https://www.phoenixcontact.com/ca/products/1881341>

Please be informed that the data shown in this PDF document is generated from our online catalog. Please find the complete data in the user documentation. Our general terms of use for downloads are valid.

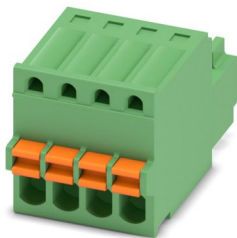

PCB connector, nominal cross section: 0.5 mm², color: green, nominal current: 4 A, rated voltage (III/2): 160 V, contact surface: Tin, contact connection type: Socket, number of potentials: 4, number of rows: 1, number of positions: 4, number of connections: 4, product range: FK-MC 0,5/.-ST, pitch: 2.5 mm, connection method: Push-in spring connection, conductor/PCB connection direction: 0 °, plug-in system: COMBICON FK-MC 0,5, locking: without, mounting: without, type of packaging: packed in cardboard

Your advantages

- Time saving push-in connection, tools not required
- Defined contact force ensures that contact remains stable over the long term
- Intuitive operation due to color-coded actuating push button
- Operation and conductor connection from one direction enable integration into front of device
- Quick and convenient testing using integrated test option

Commercial data

| | |
|--------------------------------------|---------------------|
| Item number | 1881341 |
| Packing unit | 50 pc |
| Minimum order quantity | 50 pc |
| Sales key | AA01 |
| Product key | AAAFCA |
| Catalog page | Page 168 (C-1-2013) |
| GTIN | 4017918156596 |
| Weight per piece (including packing) | 2.696 g |
| Weight per piece (excluding packing) | 2.696 g |
| Customs tariff number | 85366990 |
| Country of origin | DE |

FK-MC 0,5/ 4-ST-2,5 - PCB connector



1881341

<https://www.phoenixcontact.com/ca/products/1881341>

Technical data

Product properties

| | |
|-----------------------|------------------------|
| Product type | PCB connector |
| Product family | FK-MC 0,5/...-ST |
| Product line | COMBICON Connectors XS |
| Type | Standard |
| Number of positions | 4 |
| Pitch | 2.5 mm |
| Number of connections | 4 |
| Number of rows | 1 |
| Number of potentials | 4 |
| Mounting flange | without |

Electrical properties

| | |
|-----------------------------|--------------|
| Nominal current I_N | 4 A |
| Nominal voltage U_N | 160 V |
| Degree of pollution | 3 |
| Contact resistance | 2 m Ω |
| Rated voltage (III/3) | 100 V |
| Rated surge voltage (III/3) | 1.5 kV |
| Rated voltage (III/2) | 160 V |
| Rated surge voltage (III/2) | 2.5 kV |
| Rated voltage (II/2) | 320 V |
| Rated surge voltage (II/2) | 2.5 kV |

Connection data

Connection technology

| | |
|-------------------------|---------------------|
| Type | Standard |
| Connector system | COMBICON FK-MC 0,5 |
| Nominal cross section | 0.5 mm ² |
| Contact connection type | Socket |

Interlock

| | |
|-----------------|---------|
| Locking type | without |
| Mounting flange | without |

Conductor connection

| | |
|--|--|
| Connection method | Push-in spring connection |
| Conductor/PCB connection direction | 0 ° |
| Conductor cross section rigid | 0.14 mm ² ... 0.5 mm ² |
| Conductor cross section flexible | 0.14 mm ² ... 0.5 mm ² |
| Conductor cross section AWG | 26 ... 20 |
| Conductor cross section flexible, with ferrule without plastic | 0.25 mm ² ... 0.5 mm ² |

FK-MC 0,5/ 4-ST-2,5 - PCB connector



1881341

<https://www.phoenixcontact.com/ca/products/1881341>

| | |
|------------------------------------|------------|
| sleeve | |
| Cylindrical gauge a x b / diameter | - / 1.4 mm |
| Stripping length | 8 mm |

Specifications for ferrules without insulating collar

| | |
|--|---|
| recommended crimping tool | 1212034 CRIMPFOX 6 |
| ferrules without insulating collar, according to DIN 46228-1 | Cross section: 0.25 mm ² ; Length: 7 mm ... 8 mm |
| | Cross section: 0.34 mm ² ; Length: 7 mm ... 8 mm |
| | Cross section: 0.5 mm ² ; Length: 8 mm |

Material specifications

Material data - contact

| | |
|--|--|
| Note | WEEE/RoHS-compliant, free of whiskers according to IEC 60068-2-82/JEDEC JESD 201 |
| Contact material | Cu alloy |
| Surface characteristics | hot-dip tin-plated |
| Metal surface terminal point (top layer) | Tin (4 - 8 µm Sn) |
| Metal surface contact area (top layer) | Tin (4 - 8 µm Sn) |

Material data - housing

| | |
|---|--------------|
| Color (Housing) | green (6021) |
| Insulating material | PA |
| Insulating material group | I |
| CTI according to IEC 60112 | 600 |
| Flammability rating according to UL 94 | V0 |
| Glow wire flammability index GWFI according to EN 60695-2-12 | 850 |
| Glow wire ignition temperature GWIT according to EN 60695-2-13 | 775 |
| Temperature for the ball pressure test according to EN 60695-10-2 | 125 °C |

Material data – actuating element

| | |
|--|---------------|
| Color (Actuating element) | orange (2003) |
| Insulating material | PBT |
| Insulating material group | I |
| CTI according to IEC 60112 | 600 |
| Flammability rating according to UL 94 | V0 |

Dimensions

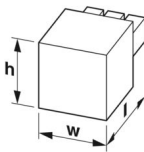
| | |
|---------------------|--|
| Dimensional drawing |  |
| Pitch | 2.5 mm |

FK-MC 0,5/ 4-ST-2,5 - PCB connector



1881341

<https://www.phoenixcontact.com/ca/products/1881341>

| | |
|------------|----------|
| Width [w] | 10.6 mm |
| Height [h] | 11.75 mm |
| Length [l] | 19.05 mm |

Notes

| | |
|--------------------|--|
| Notes on operation | In accordance with IEC 61984, COMBICON connectors have no switching power (COC). During designated use, they must not be plugged in or disconnected when carrying voltage or under load. |
|--------------------|--|

Mechanical tests

Conductor connection

| | |
|---------------|---------------------|
| Specification | IEC 60999-1:1999-11 |
| Result | Test passed |

Test for conductor damage and slackening

| | |
|---------------|---------------------|
| Specification | IEC 60999-1:1999-11 |
| Result | Test passed |

Repeated connection and disconnection

| | |
|---------------|---------------------|
| Specification | IEC 60999-1:1999-11 |
| Result | Test passed |

Pull-out test

| | |
|---|---|
| Specification | IEC 60999-1:1999-11 |
| Conductor cross section/conductor type/tractive force setpoint/actual value | 0.2 mm ² / solid / > 10 N |
| | 0.2 mm ² / flexible / > 10 N |
| | 0.5 mm ² / solid / > 20 N |
| | 0.5 mm ² / flexible / > 20 N |

Insertion and withdrawal forces

| | |
|-------------------------------------|-------------|
| Result | Test passed |
| No. of cycles | 25 |
| Insertion strength per pos. approx. | 8 N |
| Withdraw strength per pos. approx. | 6 N |

Resistance of inscriptions

| | |
|---------------|------------------------|
| Specification | IEC 60068-2-70:1995-12 |
| Result | Test passed |

Polarization and coding

| | |
|---------------|------------------------|
| Specification | IEC 60512-13-5:2006-02 |
| Result | Test passed |

Visual inspection

| | |
|---------------|-----------------------|
| Specification | IEC 60512-1-1:2002-02 |
| Result | Test passed |

Dimension check

FK-MC 0,5/ 4-ST-2,5 - PCB connector



1881341

<https://www.phoenixcontact.com/ca/products/1881341>

| | |
|---------------|-----------------------|
| Specification | IEC 60512-1-2:2002-02 |
| Result | Test passed |

Environmental and real-life conditions

Vibration test

| | |
|------------------------|-----------------------------|
| Specification | IEC 60068-2-6:2007-12 |
| Frequency | 10 - 150 - 10 Hz |
| Sweep speed | 1 octave/min |
| Amplitude | 0.35 mm (10 Hz ... 60.1 Hz) |
| Acceleration | 5g (60.1 Hz ... 150 Hz) |
| Test duration per axis | 2.5 h |

Durability test

| | |
|--|-----------------------|
| Specification | IEC 60512-9-1:2010-03 |
| Impulse withstand voltage at sea level | 2.95 kV |
| Contact resistance R ₁ | 2 mΩ |
| Contact resistance R ₂ | 2.2 mΩ |
| Insertion/withdrawal cycles | 25 |
| Insulation resistance, neighboring positions | > 5 MΩ |

Climatic test

| | |
|-----------------------------------|---|
| Specification | ISO 6988:1985-02 |
| Corrosive stress | 0.2 dm ³ SO ₂ on 300 dm ³ /40 °C/1 cycle |
| Thermal stress | 100 °C/168 h |
| Power-frequency withstand voltage | 1.39 kV |

Ambient conditions

| | |
|---|---|
| Ambient temperature (operation) | -40 °C ... 100 °C (dependent on the derating curve) |
| Ambient temperature (storage/transport) | -40 °C ... 70 °C |
| Relative humidity (storage/transport) | 30 % ... 70 % |
| Ambient temperature (assembly) | -5 °C ... 100 °C |

Electrical tests

Thermal test | Test group C

| | |
|----------------------------|-----------------------|
| Specification | IEC 60512-5-1:2002-02 |
| Tested number of positions | 12 |

Insulation resistance

| | |
|--|-----------------------|
| Specification | IEC 60512-3-1:2002-02 |
| Insulation resistance, neighboring positions | > 5 MΩ |

Temperature cycles

| | |
|---------------|---------------------|
| Specification | IEC 60999-1:1999-11 |
| Result | Test passed |

Air clearances and creepage distances |

FK-MC 0,5/ 4-ST-2,5 - PCB connector



1881341

<https://www.phoenixcontact.com/ca/products/1881341>

| | |
|--|---|
| Specification | IEC 60664-1:1992-10 + A1:2000-02 + A2:2002-05 |
| Insulating material group | I |
| Comparative tracking index (IEC 60112) | CTI 600 |
| Rated insulation voltage (III/3) | 100 V |
| Rated surge voltage (III/3) | 1.5 kV |
| minimum clearance value - non-homogenous field (III/3) | 0.8 mm |
| minimum creepage distance (III/3) | 1.8 mm |
| Rated insulation voltage (III/2) | 160 V |
| Rated surge voltage (III/2) | 2.5 kV |
| minimum clearance value - non-homogenous field (III/2) | 1.5 mm |
| minimum creepage distance (III/2) | 1.5 mm |
| Rated insulation voltage (II/2) | 320 V |
| Rated surge voltage (II/2) | 2.5 kV |
| minimum clearance value - non-homogenous field (II/2) | 1.5 mm |
| minimum creepage distance (II/2) | 1.6 mm |

Packaging specifications

| | |
|-------------------|---------------------|
| Type of packaging | packed in cardboard |
|-------------------|---------------------|

FK-MC 0,5/ 4-ST-2,5 - PCB connector

1881341

<https://www.phoenixcontact.com/ca/products/1881341>

Drawings

Dimensional drawing

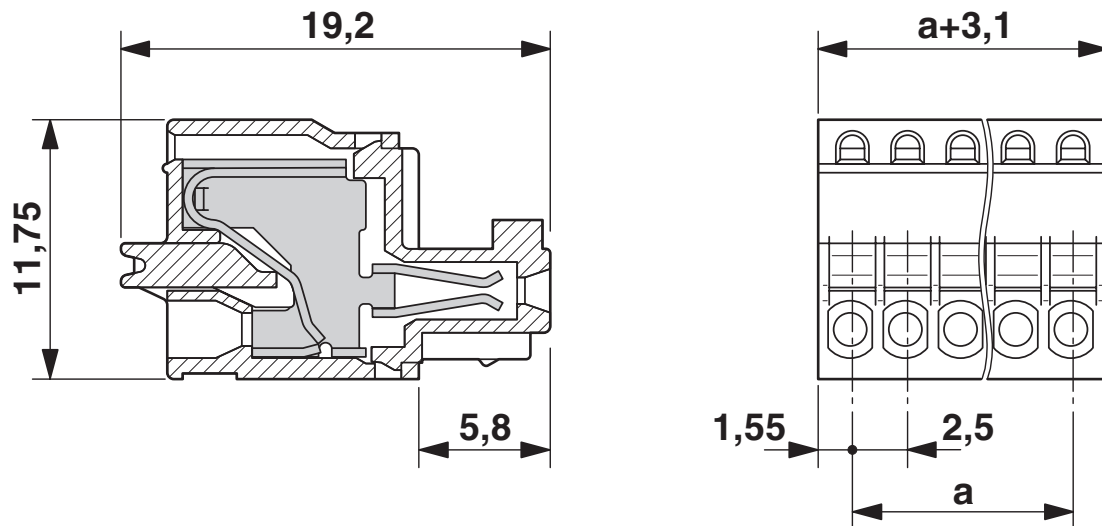

Diagram

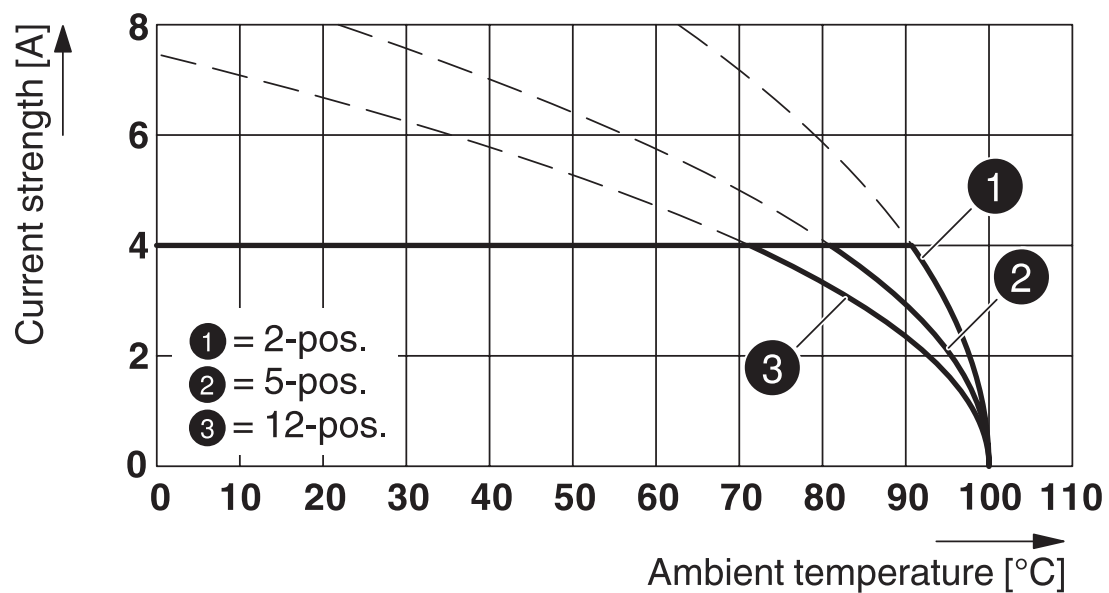

Type: FK-MC 0,5/...-ST-2,5 with MCD 0,5/...-G1-2,5 HT BK

FK-MC 0,5/ 4-ST-2,5 - PCB connector



1881341

<https://www.phoenixcontact.com/ca/products/1881341>

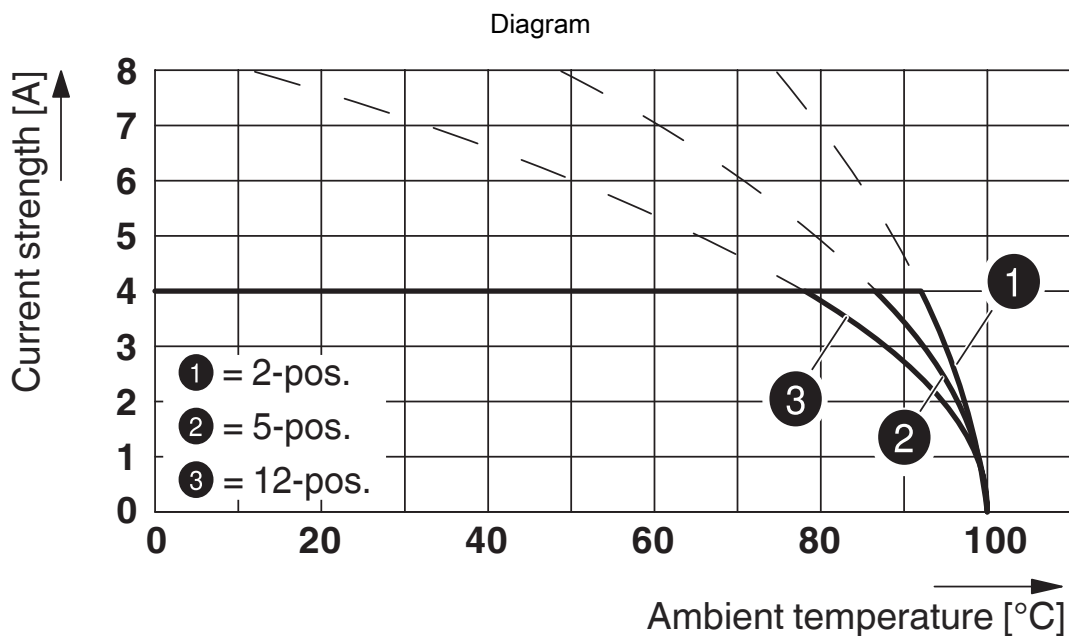

Type: FK-MC 0,5/...-ST-2,5 with MCV 0,5/...-G-2,5 THT

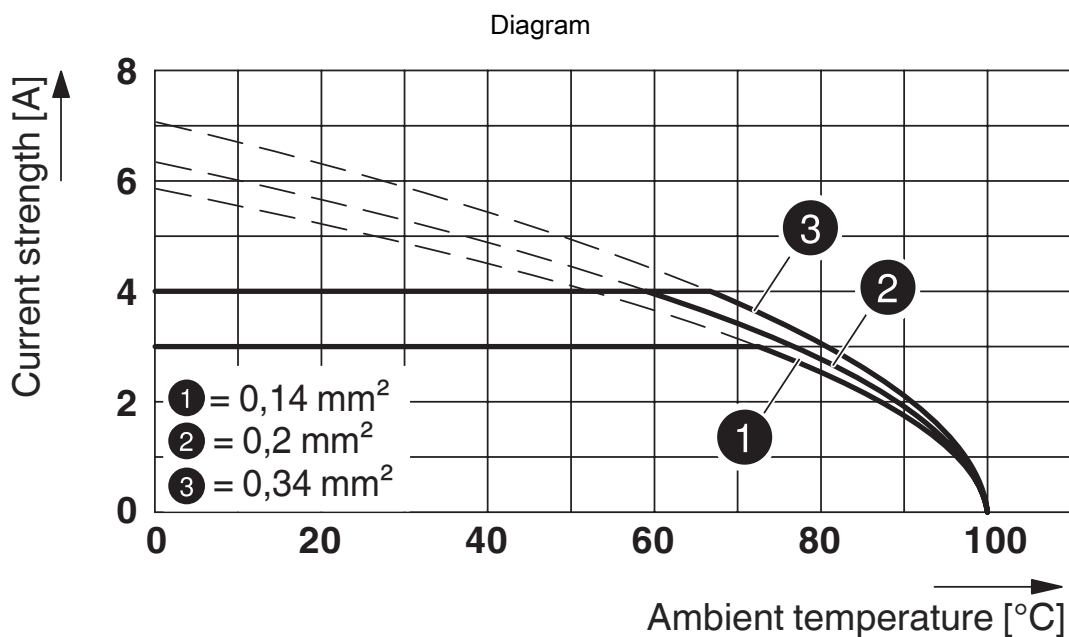

Type: FK-MC 0,5/...-ST-2,5 with MC 0,5/...-G-2,5

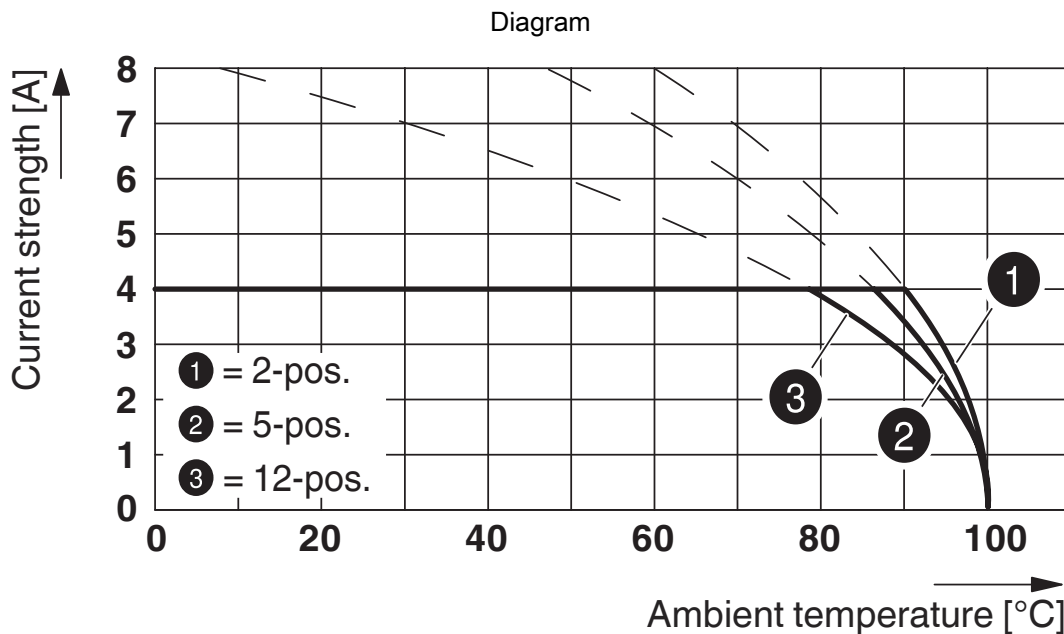

Type: FK-MC 0,5/...-ST-2,5 with MC 0,5/...-G-2,5 THT

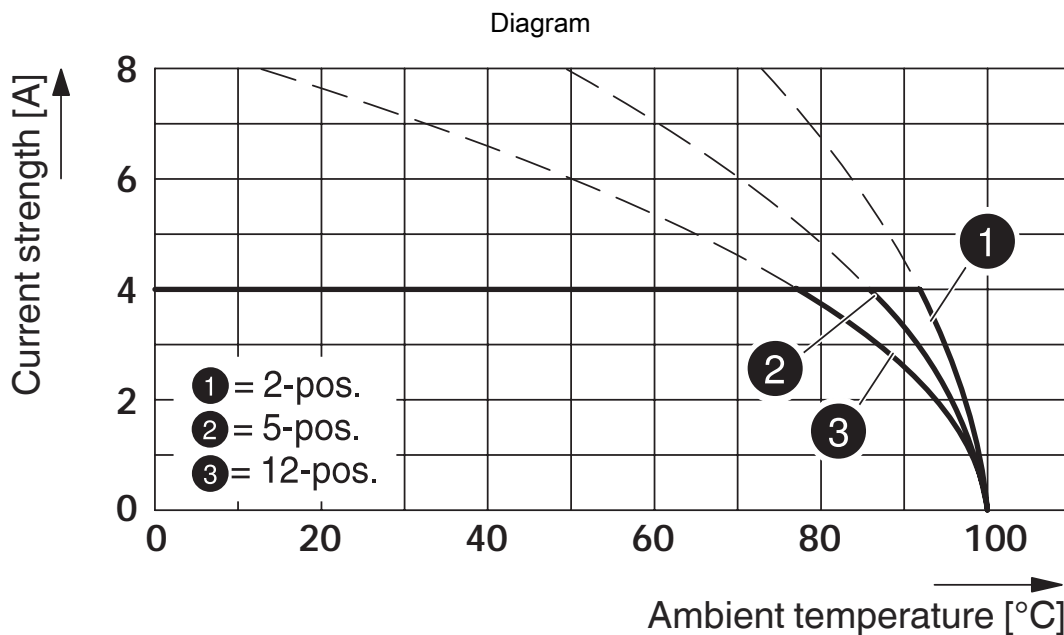

Type: FK-MC 0,5/...-ST-2,5 with MC 0,5/...-G-2,5

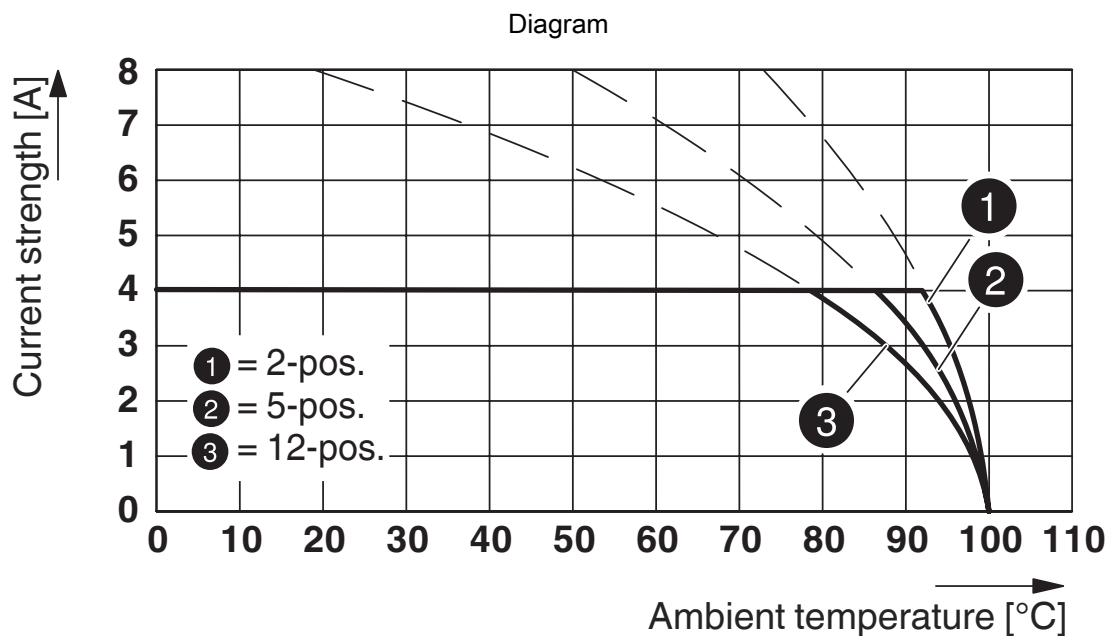

Type: FK-MC 0,5/...-ST-2,5 with MCV 0,5/...-G-2,5

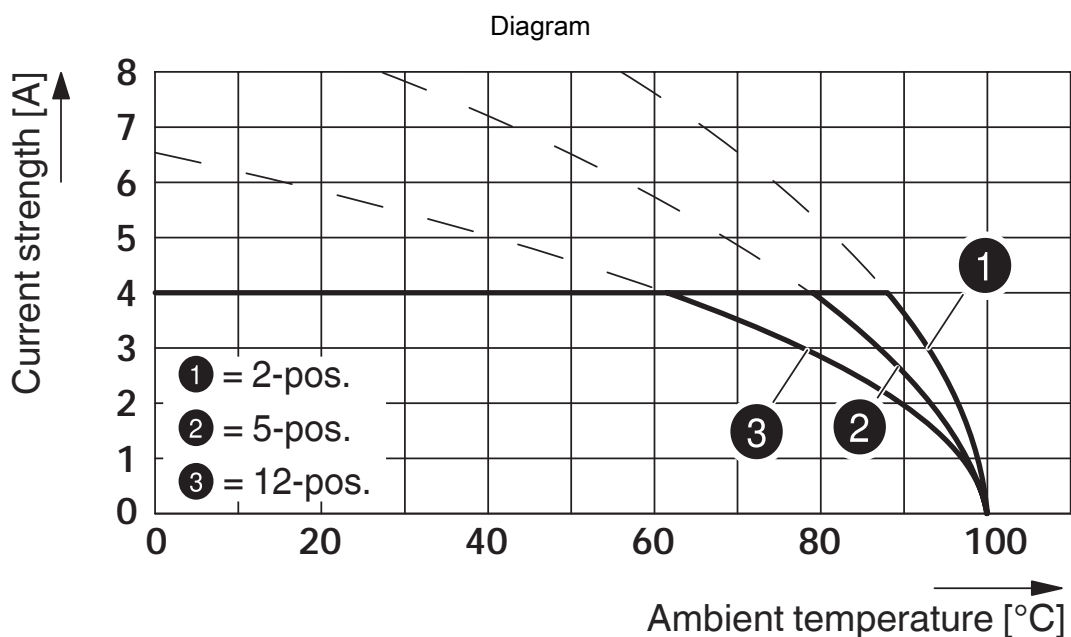

Type: FK-MC 0,5/...-ST-2,5 with MCD 0,5/...-G1-2,5

FK-MC 0,5/ 4-ST-2,5 - PCB connector





1881341

<https://www.phoenixcontact.com/ca/products/1881341>

Approvals

To download certificates, visit the product detail page: <https://www.phoenixcontact.com/ca/products/1881341>

|  cULus Recognized Approval ID: E60425-19990913 | | | | |
|---|-----------------------|-----------------------|-------------------|-----------------------------|
| | Nominal voltage U_N | Nominal current I_N | Cross section AWG | Cross section mm^2 |
| Use group B | | | | |
| | 125 V | 4 A | 28 - 20 | - |

|  VDE Gutachten mit Fertigungsüberwachung Approval ID: 40013394 | | | | |
|---|-----------------------|-----------------------|-------------------|-----------------------------|
| | Nominal voltage U_N | Nominal current I_N | Cross section AWG | Cross section mm^2 |
| | 100 V | 4 A | - | 0.2 - 0.5 |

FK-MC 0,5/ 4-ST-2,5 - PCB connector



1881341

<https://www.phoenixcontact.com/ca/products/1881341>

Classifications

ECLASS

| | |
|-------------|----------|
| ECLASS-11.0 | 27460202 |
| ECLASS-12.0 | 27460202 |
| ECLASS-13.0 | 27460202 |

ETIM

| | |
|----------|----------|
| ETIM 9.0 | EC002638 |
|----------|----------|

UNSPSC

| | |
|-------------|----------|
| UNSPSC 21.0 | 39121400 |
|-------------|----------|

FK-MC 0,5/ 4-ST-2,5 - PCB connector



1881341

<https://www.phoenixcontact.com/ca/products/1881341>

Environmental product compliance

EU RoHS

| | |
|---|--------------------|
| Fulfills EU RoHS substance requirements | Yes, No exemptions |
|---|--------------------|

China RoHS

| | |
|--|--|
| Environment friendly use period (EFUP) | EFUP-E |
| | No hazardous substances above the limits |

EU REACH SVHC

| | |
|-------------------------------------|----------------------------|
| REACH candidate substance (CAS No.) | No substance above 0.1 wt% |
|-------------------------------------|----------------------------|

EF3.0 Climate Change

| | |
|---------|---------------|
| CO2e kg | 0.031 kg CO2e |
|---------|---------------|

Phoenix Contact 2024 © - all rights reserved
<https://www.phoenixcontact.com>

PHOENIX CONTACT Ltd
8240 Parkhill Drive
Milton, Ontario L9T 5V7
1-800-890-2820
cdinfo@phoenixcontact.ca