

MCVR 1,5/16-STF-3,81 - PCB connector



1828485

<https://www.phoenixcontact.com/it/products/1828485>

Please be informed that the data shown in this PDF document is generated from our online catalog. Please find the complete data in the user documentation. Our general terms of use for downloads are valid.



PCB connector, nominal cross section: 1.5 mm², color: green, nominal current: 8 A, rated voltage (III/2): 160 V, contact surface: Tin, contact connection type: Socket, number of potentials: 16, number of rows: 1, number of positions: 16, number of connections: 16, product range: MCVR 1,5/...-STF, pitch: 3.81 mm, connection method: Screw connection with tension sleeve, screw head form: L Slotted, conductor/PCB connection direction: 90 °, plug-in system: COMBICON MC 1,5, locking: Screw locking mechanism, mounting: Screw flange, type of packaging: packed in cardboard

Your advantages

- Well-known connection principle allows worldwide use
- Low temperature rise, thanks to maximum contact force
- Allows connection of two conductors
- Screwable flange for superior mechanical stability

Commercial data

Item number	1828485
Packing unit	50 pc
Minimum order quantity	50 pc
Sales key	AAB
Product key	AABAEB
Catalog page	Page 193 (C-1-2013)
GTIN	4017918114794
Weight per piece (including packing)	13.792 g
Weight per piece (excluding packing)	13.17 g
Customs tariff number	85366990
Country of origin	DE

MCVR 1,5/16-STF-3,81 - PCB connector



1828485

<https://www.phoenixcontact.com/it/products/1828485>

Technical data

Product properties

Type	Standard
Product line	COMBICON Connectors S
Product type	PCB connector
Product family	MCVR 1,5/...-STF
Number of positions	16
Pitch	3.81 mm
Number of connections	16
Number of rows	1
Mounting flange	Screw flange
Number of potentials	16

Electrical properties

Nominal current I_N	8 A
Nominal voltage U_N	160 V
Degree of pollution	3
Contact resistance	3.4 m Ω
Rated voltage (III/3)	160 V
Rated surge voltage (III/3)	2.5 kV
Rated voltage (III/2)	160 V
Rated surge voltage (III/2)	2.5 kV
Rated voltage (II/2)	320 V
Rated surge voltage (II/2)	2.5 kV

Connection data

Connection technology

Type	Standard
Connector system	COMBICON MC 1,5
Nominal cross section	1.5 mm ²
Contact connection type	Socket

Interlock

Locking type	Screw locking mechanism
Mounting flange	Screw flange
Tightening torque	0.3 Nm

Conductor connection

Connection method	Screw connection with tension sleeve
Conductor/PCB connection direction	90 °
Conductor cross section rigid	0.14 mm ² ... 1.5 mm ²
Conductor cross section flexible	0.14 mm ² ... 1.5 mm ²
Conductor cross section AWG	28 ... 16

MCVR 1,5/16-STF-3,81 - PCB connector



1828485

<https://www.phoenixcontact.com/it/products/1828485>

Conductor cross section flexible, with ferrule without plastic sleeve	0.25 mm ² ... 1.5 mm ²
Conductor cross section, flexible, with ferrule, with plastic sleeve	0.25 mm ² ... 0.5 mm ²
2 conductors with same cross section, solid	0.08 mm ² ... 0.5 mm ²
2 conductors with same cross section, flexible	0.08 mm ² ... 0.75 mm ²
2 conductors with same cross section, flexible, with ferrule without plastic sleeve	0.25 mm ² ... 0.34 mm ²
2 conductors with the same cross section, flexible, with TWIN ferrule with plastic sleeve	0.5 mm ² ... 0.5 mm ²
Cylindrical gauge a x b / diameter	2.4 mm x 1.5 mm / 1.6 mm
Stripping length	7 mm
Tightening torque	0.22 Nm ... 0.25 Nm

Specifications for ferrules without insulating collar

recommended crimping tool	1212034 CRIMPFOX 6
---------------------------	--------------------

Specifications for ferrules with insulating collar

recommended crimping tool	1212034 CRIMPFOX 6
---------------------------	--------------------

Material specifications

Material data - contact

Note	WEEE/RoHS-compliant, free of whiskers according to IEC 60068-2-82/JEDEC JESD 201
Contact material	Cu alloy
Surface characteristics	hot-dip tin-plated
Metal surface terminal point (top layer)	Tin (4 - 8 µm Sn)
Metal surface contact area (top layer)	Tin (4 - 8 µm Sn)

Material data - housing

Color (Housing)	green (6021)
Insulating material	PA
Insulating material group	I
CTI according to IEC 60112	600
Flammability rating according to UL 94	V0
Glow wire flammability index GWFI according to EN 60695-2-12	850
Glow wire ignition temperature GWIT according to EN 60695-2-13	775
Temperature for the ball pressure test according to EN 60695-10-2	125 °C

Dimensions

MCVR 1,5/16-STF-3,81 - PCB connector



1828485

<https://www.phoenixcontact.com/it/products/1828485>

Dimensional drawing	
Pitch	3.81 mm
Width [w]	71.35 mm
Height [h]	19.1 mm
Length [l]	10.4 mm

Mounting

Drive form screw head	Slotted (L)
Drive form screw head	Slotted (L)

Flange

Tightening torque	0.3 Nm
-------------------	--------

Mechanical tests

Test for conductor damage and slackening

Specification	IEC 60999-1:1999-11
Result	Test passed

Pull-out test

Specification	IEC 60999-1:1999-11
Conductor cross section/conductor type/tractive force setpoint/actual value	0.14 mm ² / solid / > 10 N
	0.14 mm ² / flexible / > 10 N
	1.5 mm ² / solid / > 40 N
	1.5 mm ² / flexible / > 40 N

Insertion and withdrawal forces

Result	Test passed
No. of cycles	25
Insertion strength per pos. approx.	8 N
Withdraw strength per pos. approx.	6 N

Torque test

Specification	IEC 60999-1:1999-11
---------------	---------------------

Resistance of inscriptions

Specification	IEC 60068-2-70:1995-12
Result	Test passed

Polarization and coding

Specification	IEC 60512-13-5:2006-02
---------------	------------------------

MCVR 1,5/16-STF-3,81 - PCB connector



1828485

<https://www.phoenixcontact.com/it/products/1828485>

Result	Test passed
--------	-------------

Visual inspection

Specification	IEC 60512-1-1:2002-02
Result	Test passed

Dimension check

Specification	IEC 60512-1-2:2002-02
Result	Test passed

Environmental and real-life conditions

Vibration test

Specification	IEC 60068-2-6:2007-12
Frequency	10 - 150 - 10 Hz
Sweep speed	1 octave/min
Amplitude	0.35 mm (10 Hz ... 60.1 Hz)
Sweep speed	5g (60.1 Hz ... 150 Hz)
Test duration per axis	2.5 h

Durability test

Specification	IEC 60512-9-1:2010-03
Impulse withstand voltage at sea level	2.95 kV
Contact resistance R_1	3.4 m Ω
Contact resistance R_2	3.6 m Ω
Insertion/withdrawal cycles	25
Insulation resistance, neighboring positions	> 5 M Ω

Climatic test

Specification	ISO 6988:1985-02
Corrosive stress	0.2 dm ³ SO ₂ on 300 dm ³ /40 °C/1 cycle
Thermal stress	100 °C/168 h
Power-frequency withstand voltage	1.39 kV

Ambient conditions

Ambient temperature (operation)	-40 °C ... 100 °C (dependent on the derating curve)
Ambient temperature (storage/transport)	-40 °C ... 70 °C
Relative humidity (storage/transport)	30 % ... 70 %
Ambient temperature (assembly)	-5 °C ... 100 °C

Electrical tests

Thermal test | Test group C

Specification	IEC 60512-5-1:2002-02
Tested number of positions	16

Insulation resistance

Specification	IEC 60512-3-1:2002-02
---------------	-----------------------

MCVR 1,5/16-STF-3,81 - PCB connector



1828485

<https://www.phoenixcontact.com/it/products/1828485>

Insulation resistance, neighboring positions	> 5 MΩ
--	--------

Air clearances and creepage distances |

Specification	IEC 60664-1:2007-04
Insulating material group	I
Comparative tracking index (IEC 60112)	CTI 600
Rated insulation voltage (III/3)	160 V
Rated surge voltage (III/3)	2.5 kV
minimum clearance value - non-homogenous field (III/3)	1.5 mm
minimum creepage distance (III/3)	2 mm
Rated insulation voltage (III/2)	160 V
Rated surge voltage (III/2)	2.5 kV
minimum clearance value - non-homogenous field (III/2)	1.5 mm
minimum creepage distance (III/2)	1.5 mm
Rated insulation voltage (II/2)	320 V
Rated surge voltage (II/2)	2.5 kV
minimum clearance value - non-homogenous field (II/2)	1.5 mm
minimum creepage distance (II/2)	1.6 mm

Packaging specifications

Type of packaging	packed in cardboard
-------------------	---------------------

Drawings

Diagram

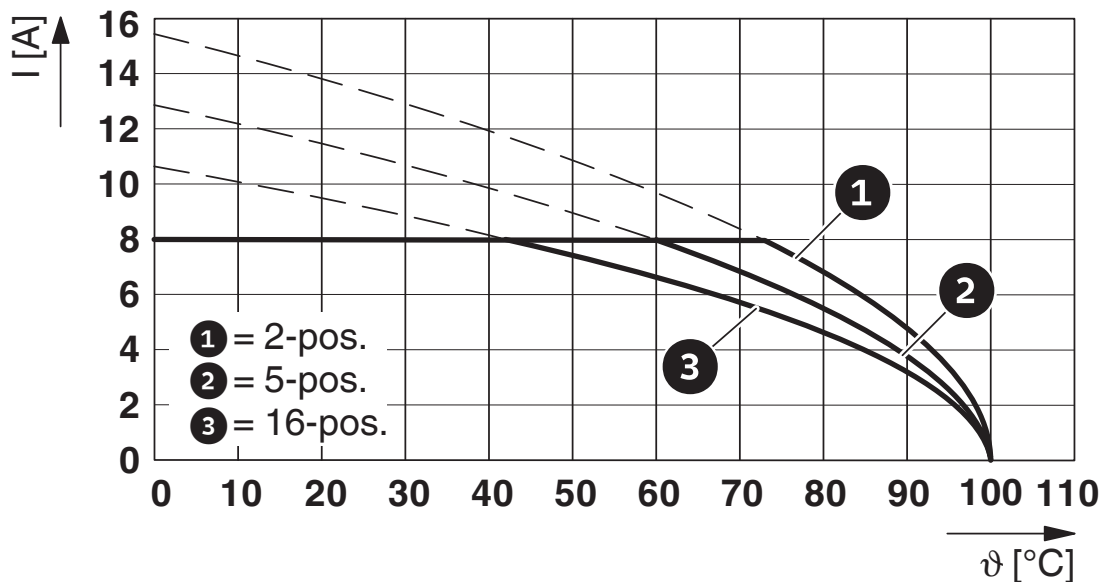

Type: MCVR(W/R) 1,5/...-STF-3,81 with MCV 1,5/...-GF-3,81 P...THR

Diagram

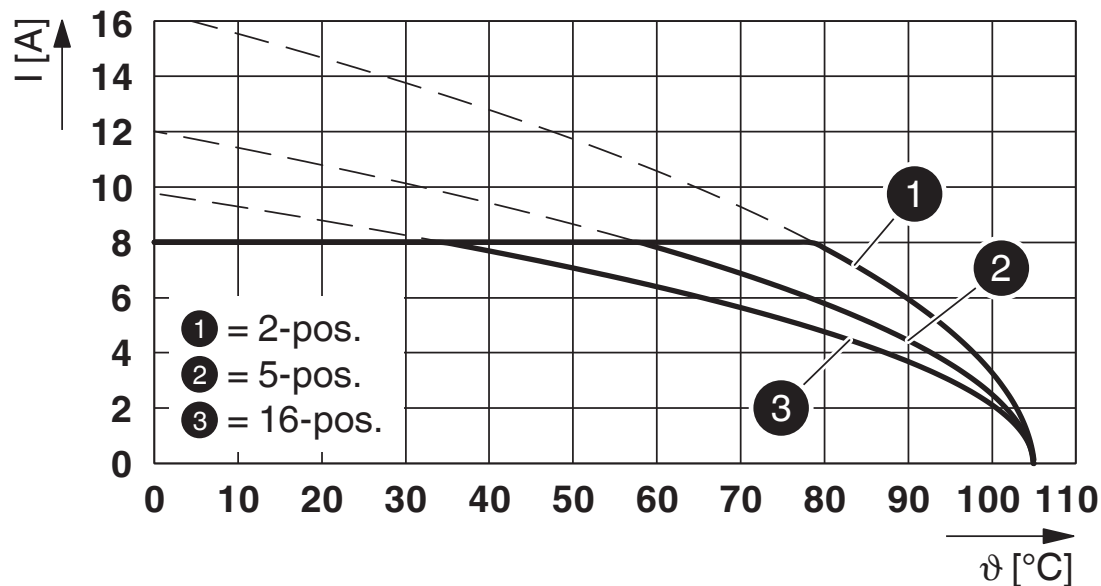

Type: MCVR 1,5/...-STF-3,81 with MCDV 1,5/...-G1F-3,81

MCVR 1,5/16-STF-3,81 - PCB connector



1828485

<https://www.phoenixcontact.com/it/products/1828485>

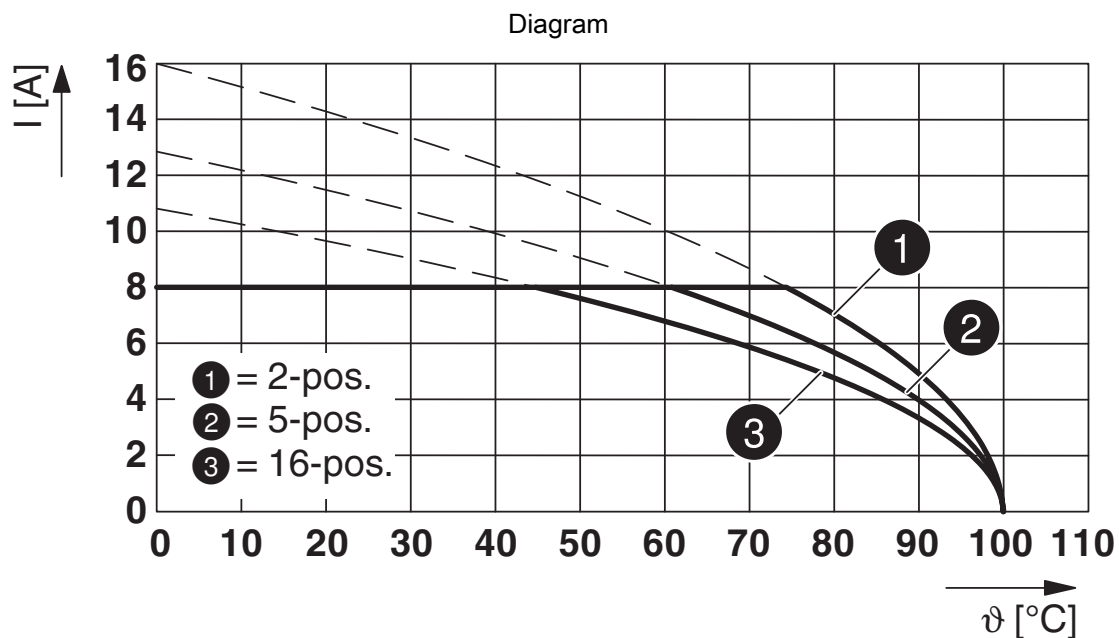

Type: MCV(W/R) 1,5/...-STF-3,81 with SMC 1,5/...-GF-3,81

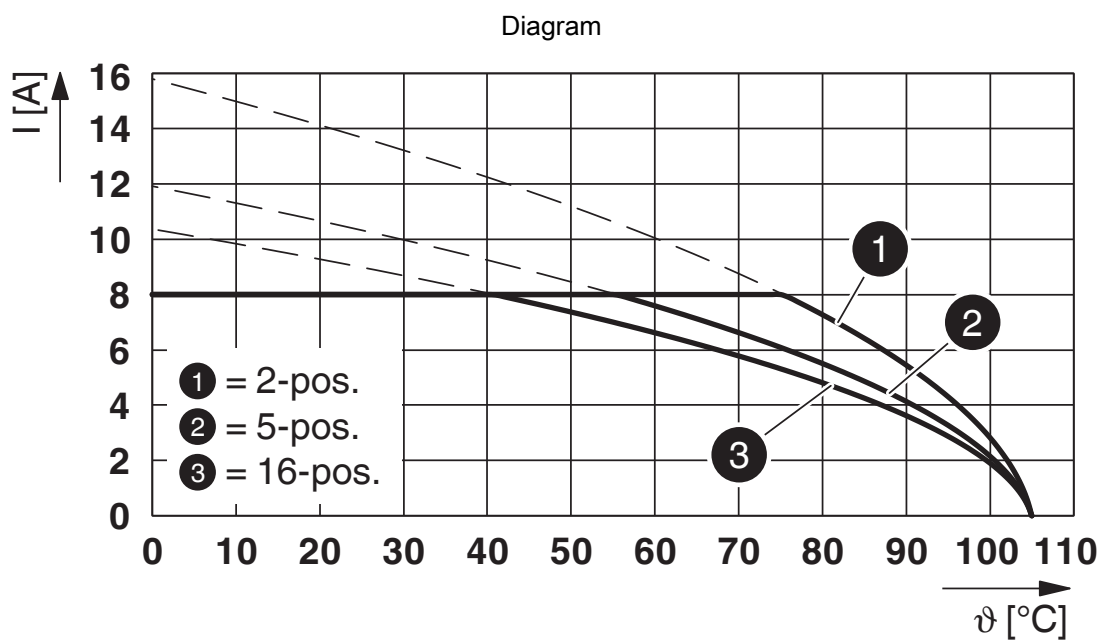

Type: MCVR 1,5/...-STF-3,81 with MCDV 1,5/...-GF-3,81

MCVR 1,5/16-STF-3,81 - PCB connector



1828485

<https://www.phoenixcontact.com/it/products/1828485>

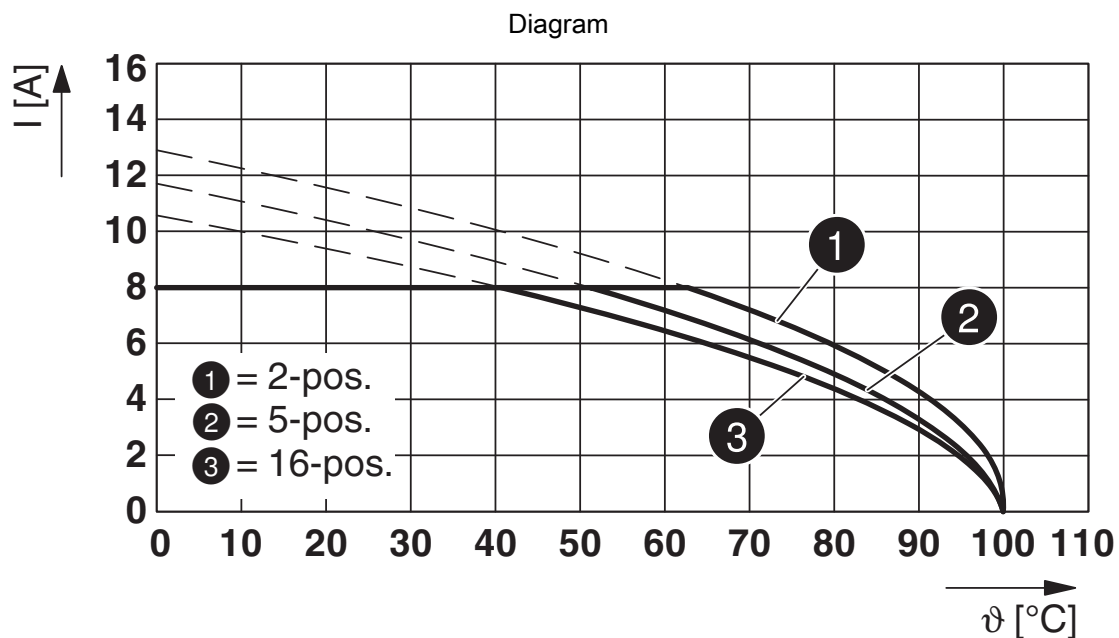

Type: MCV(W/R) 1,5/...-STF-3,81 with MC 1,5/...-GF-3,81

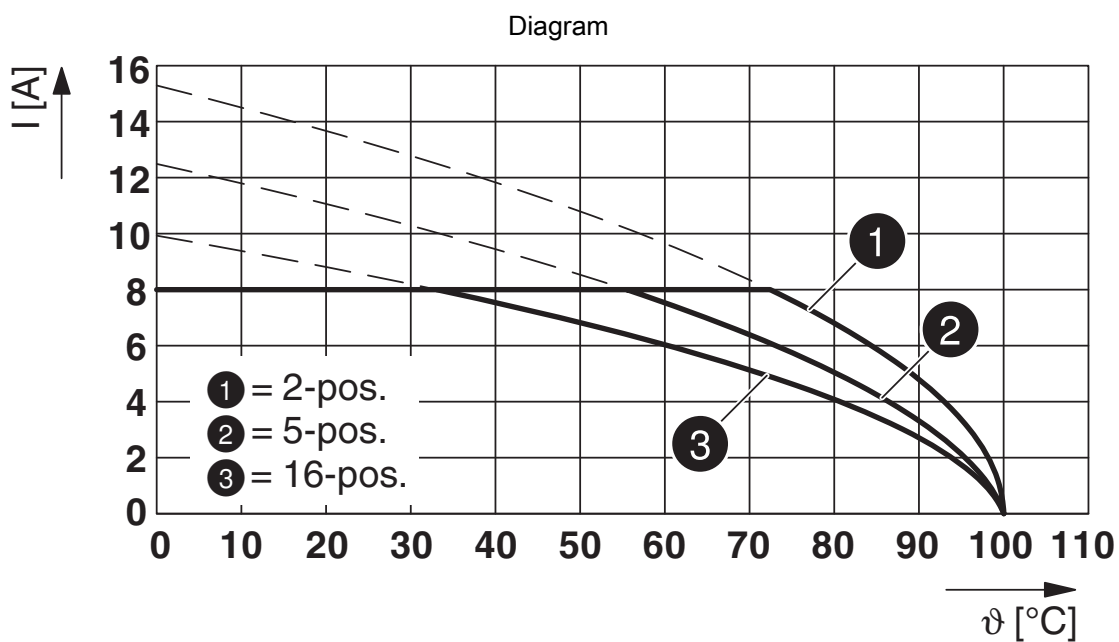

Type: MCV(W/R) 1,5/...-STF-3,81 with MCD 1,5/...-G1F-3,81

MCVR 1,5/16-STF-3,81 - PCB connector



1828485

<https://www.phoenixcontact.com/it/products/1828485>

Diagram

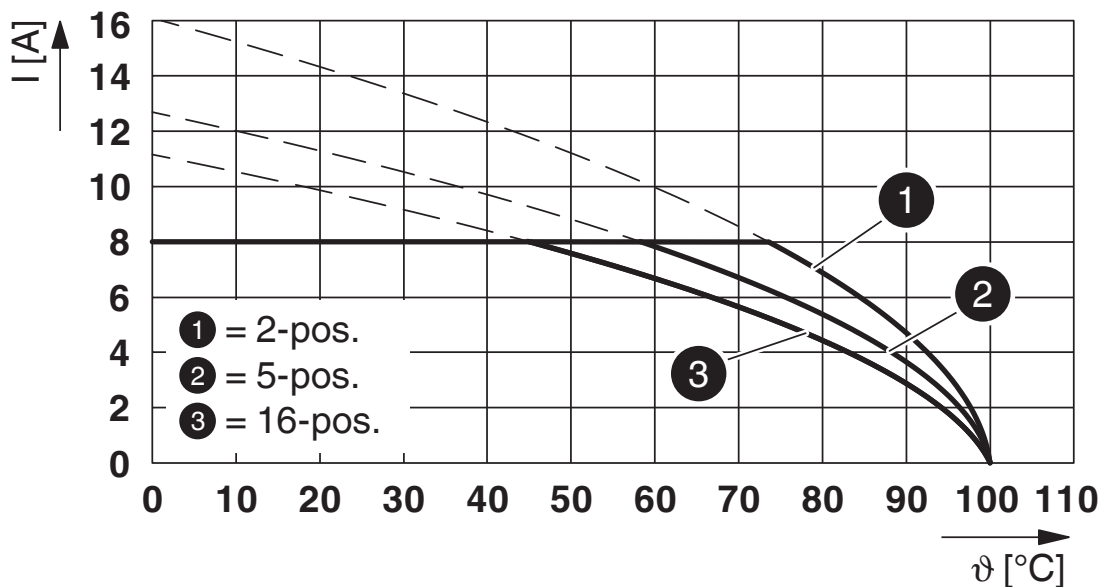

Type: MCV(W/R) 1,5/...-STF-3,81 with MCV 1,5/...-GF-3,81

Diagram

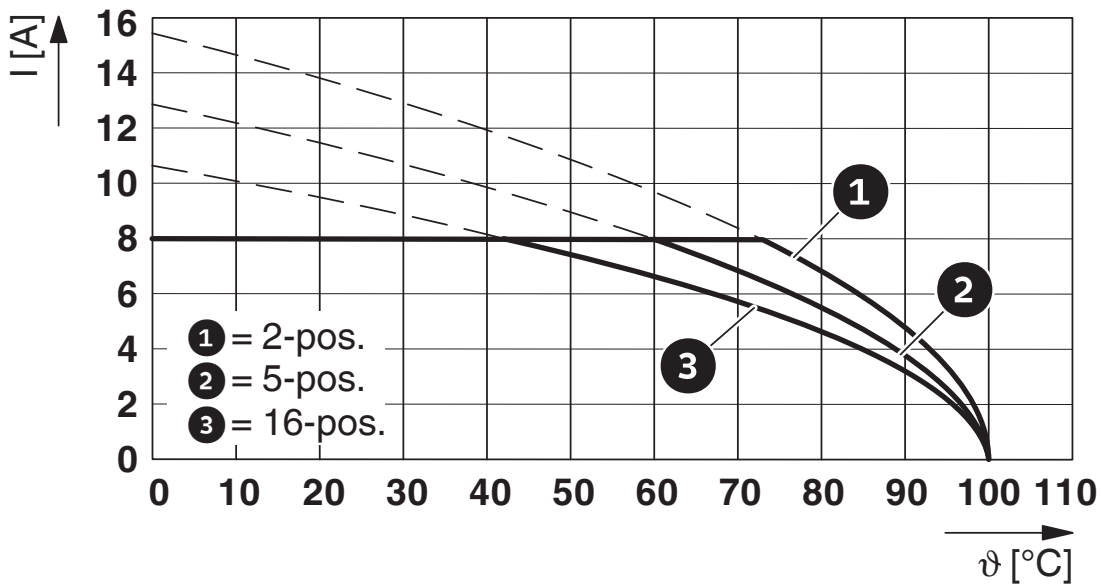

Type: MCV(W/R) 1,5/...-STF-3,81 with MC 1,5/...-GF-3,81 P...THR

MCVR 1,5/16-STF-3,81 - PCB connector



1828485

<https://www.phoenixcontact.com/it/products/1828485>

Diagram

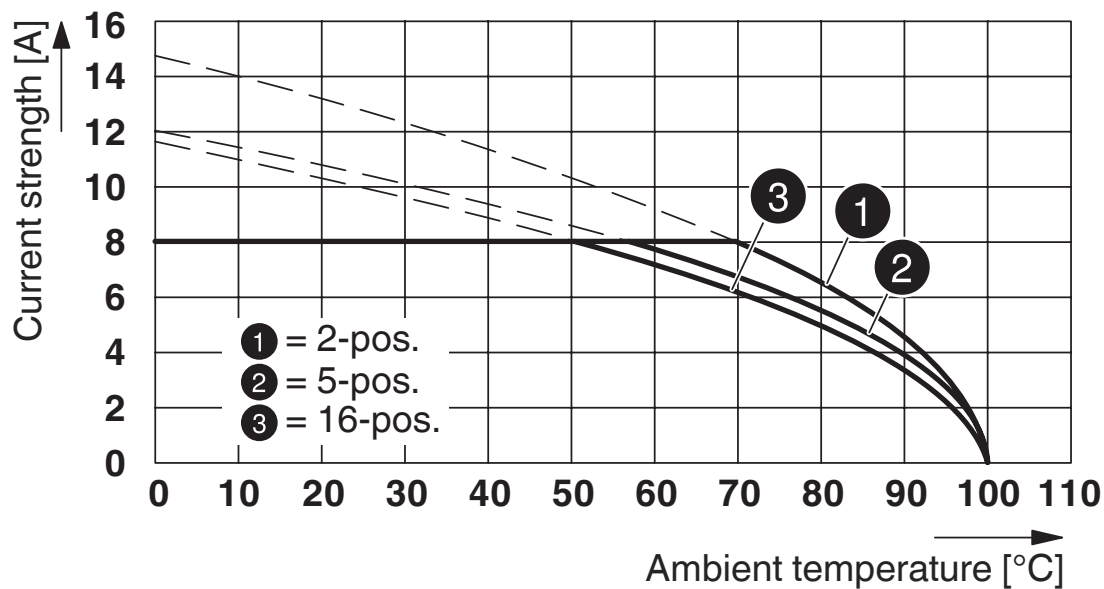

Type: MCVR 1,5/...-STF-3,81 with MCVU 1,5/...-GFD-3,81

Dimensional drawing

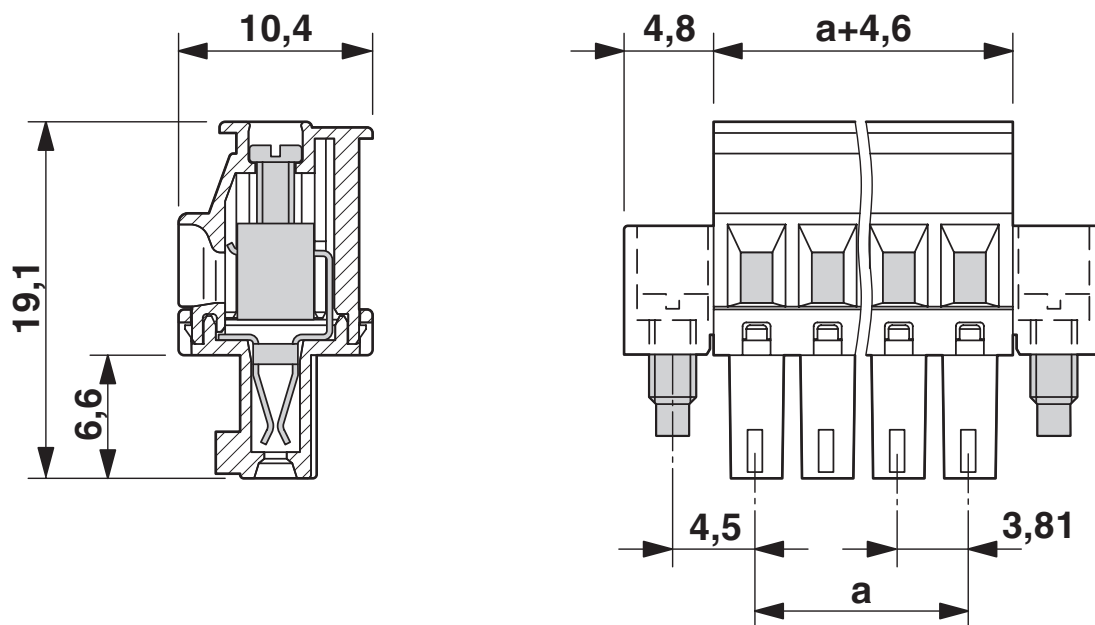

MCVR 1,5/16-STF-3,81 - PCB connector



1828485

<https://www.phoenixcontact.com/it/products/1828485>

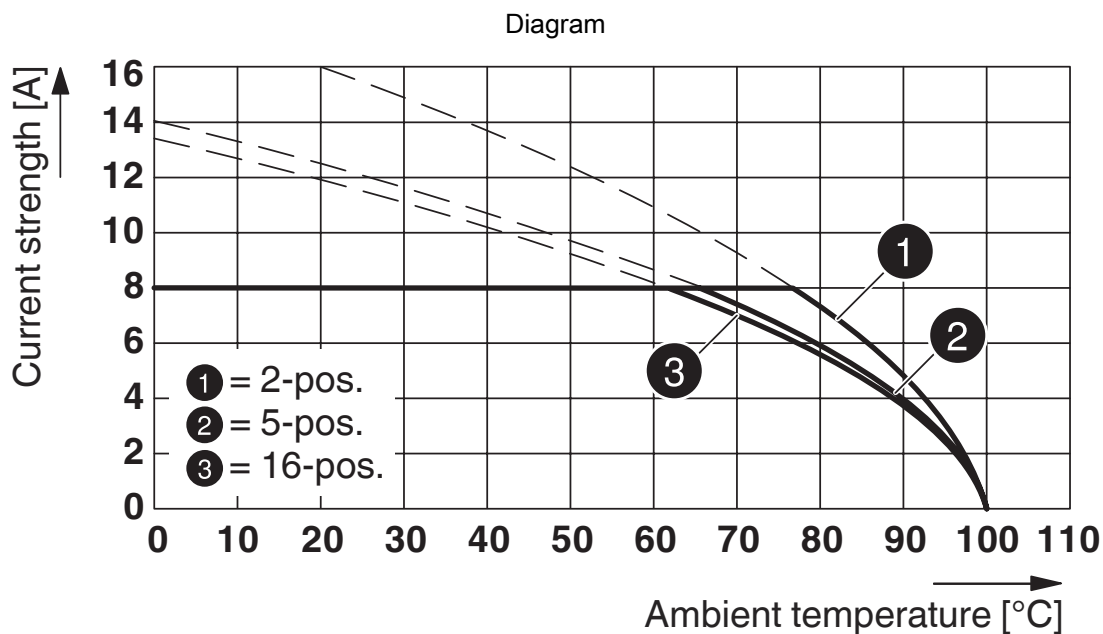

Type: MCV(W/R) 1,5/...-STF-3,81 with IMC 1,5/...-STGF-3,81

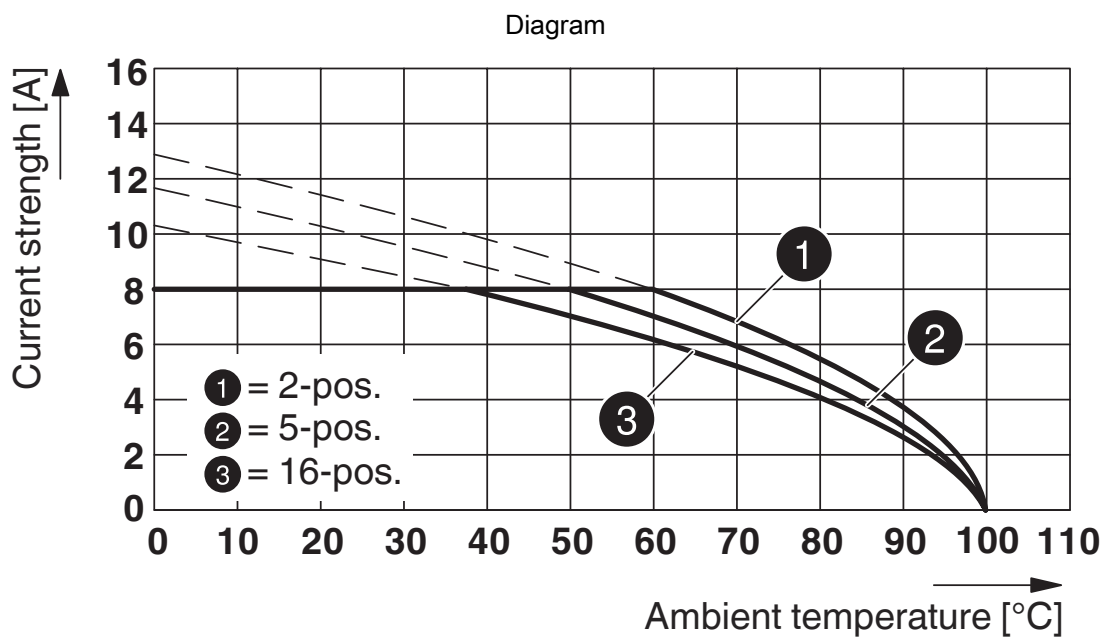

Type: MCVR 1,5/...-STF-3,81 with DFK-MC 1,5/...-GF-3,81

MCVR 1,5/16-STF-3,81 - PCB connector





1828485

<https://www.phoenixcontact.com/it/products/1828485>

Approvals

To download certificates, visit the product detail page: <https://www.phoenixcontact.com/it/products/1828485>

 CSA Approval ID: 13631				
	Nominal voltage U_N	Nominal current I_N	Cross section AWG	Cross section mm^2
Use group B	300 V	8 A	28 - 16	-
Use group D	300 V	8 A	28 - 16	-

 cULus Recognized Approval ID: E60425-20110128				
	Nominal voltage U_N	Nominal current I_N	Cross section AWG	Cross section mm^2
Use group B	300 V	8 A	30 - 14	-
Use group D	300 V	8 A	30 - 14	-

 VDE Zeichengenehmigung Approval ID: 40011723				
	Nominal voltage U_N	Nominal current I_N	Cross section AWG	Cross section mm^2
	160 V	8 A	-	0.2 - 1.5

MCVR 1,5/16-STF-3,81 - PCB connector



1828485

<https://www.phoenixcontact.com/it/products/1828485>

Classifications

ECLASS

ECLASS-11.0	27460202
ECLASS-12.0	27460202
ECLASS-13.0	27460202

ETIM

ETIM 9.0	EC002638
----------	----------

UNSPSC

UNSPSC 21.0	39121400
-------------	----------

MCVR 1,5/16-STF-3,81 - PCB connector



1828485

<https://www.phoenixcontact.com/lt/products/1828485>

Environmental product compliance

China RoHS	Environmentally friendly use period: unlimited = EFUP-e
	No hazardous substances above threshold values

Phoenix Contact 2024 © - all rights reserved
<https://www.phoenixcontact.com>

Phoenix Contact UAB
Svitrigailos str. 11B
03228 Vilnius
+370 5 2106321
balticinfo@phoenixcontact.com