

MSTB 2,5/ 3-ST-5,08 BK AU - PCB connector



1765564

<https://www.phoenixcontact.com/pc/products/1765564>

Please be informed that the data shown in this PDF document is generated from our online catalog. Please find the complete data in the user documentation. Our general terms of use for downloads are valid.



PCB connector, nominal cross section: 2.5 mm², color: black, nominal current: 12 A, rated voltage (III/2): 320 V, contact surface: Gold, contact connection type: Socket, number of potentials: 3, number of rows: 1, number of positions: 3, number of connections: 3, product range: MSTB 2,5/...-ST, pitch: 5.08 mm, connection method: Screw connection with tension sleeve, screw head form: L Slotted, conductor/PCB connection direction: 0 °, locking clip: - Locking clip, plug-in system: COMBICON MSTB 2,5, locking: without, mounting: without, type of packaging: packed in cardboard

Your advantages

- Gold-plated contacts ensure transfer quality remains stable over the long term
- Well-known connection principle allows worldwide use
- Low temperature rise, thanks to maximum contact force
- Allows connection of two conductors

Commercial data

Item number	1765564
Packing unit	50 pc
Minimum order quantity	50 pc
Product key	AACAGC
GTIN	4017918227937
Weight per piece (including packing)	5.41 g
Weight per piece (excluding packing)	5.052 g
Customs tariff number	85366990
Country of origin	DE

MSTB 2,5/ 3-ST-5,08 BK AU - PCB connector



1765564

<https://www.phoenixcontact.com/pc/products/1765564>

Technical data

Product properties

Product type	PCB connector
Product family	MSTB 2,5/..-ST
Product line	COMBICON Connectors M
Type	Standard
Number of positions	3
Pitch	5.08 mm
Number of connections	3
Number of rows	1
Number of potentials	3
Mounting flange	no

Electrical properties

Nominal current I_N	12 A
Nominal voltage U_N	320 V
Degree of pollution	3
Contact resistance	2.8 m Ω
Rated voltage (III/3)	250 V
Rated surge voltage (III/3)	4 kV
Rated voltage (III/2)	320 V
Rated surge voltage (III/2)	4 kV
Rated voltage (II/2)	630 V
Rated surge voltage (II/2)	4 kV

Connection data

Connection technology

Type	Standard
Connector system	COMBICON MSTB 2,5
Nominal cross section	2.5 mm ²
Contact connection type	Socket

Interlock

Locking type	without
Mounting flange	without

Conductor connection

Connection method	Screw connection with tension sleeve
Conductor/PCB connection direction	0 °
Conductor cross section rigid	0.2 mm ² ... 2.5 mm ²
Conductor cross section flexible	0.2 mm ² ... 2.5 mm ²
Conductor cross section AWG	24 ... 12
Conductor cross section flexible, with ferrule without plastic	0.25 mm ² ... 2.5 mm ²

MSTB 2,5/ 3-ST-5,08 BK AU - PCB connector



1765564

<https://www.phoenixcontact.com/pc/products/1765564>

sleeve	
Conductor cross section, flexible, with ferrule, with plastic sleeve	0.25 mm ² ... 2.5 mm ²
2 conductors with same cross section, solid	0.2 mm ² ... 1 mm ²
2 conductors with same cross section, flexible	0.2 mm ² ... 1.5 mm ²
2 conductors with same cross section, flexible, with ferrule without plastic sleeve	0.25 mm ² ... 1 mm ²
2 conductors with the same cross section, flexible, with TWIN ferrule with plastic sleeve	0.5 mm ² ... 1.5 mm ²
Cylindrical gauge a x b / diameter	2.8 mm x 2.0 mm / 2.4 mm
Stripping length	7 mm
Tightening torque	0.5 Nm ... 0.6 Nm

Specifications for ferrules without insulating collar

recommended crimping tool	1212034 CRIMPFOX 6
---------------------------	--------------------

Specifications for ferrules with insulating collar

recommended crimping tool	1212034 CRIMPFOX 6
---------------------------	--------------------

Material specifications

Material data - contact

Note	WEEE/RoHS-compliant, free of whiskers according to IEC 60068-2-82/JEDEC JESD 201
Contact material	Cu alloy
Surface characteristics	partially gold-plated
Metal surface terminal point (top layer)	Tin (4 - 8 µm Sn)
Metal surface terminal point (middle layer)	Nickel (2 - 4 µm Ni)
Metal surface contact area (top layer)	Gold (0.8 - 1.4 µm Au)
Metal surface contact area (middle layer)	Nickel (2 - 4 µm Ni)

Material data - housing

Color (Housing)	black (9005)
Insulating material	PA
Insulating material group	I
CTI according to IEC 60112	600
Flammability rating according to UL 94	V0
Glow wire flammability index GWFI according to EN 60695-2-12	850
Glow wire ignition temperature GWIT according to EN 60695-2-13	775
Temperature for the ball pressure test according to EN 60695-10-2	125 °C

Dimensions

MSTB 2,5/ 3-ST-5,08 BK AU - PCB connector



1765564

<https://www.phoenixcontact.com/pc/products/1765564>

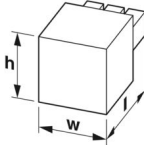
Dimensional drawing	
Pitch	5.08 mm
Width [w]	15.24 mm
Height [h]	15 mm
Length [l]	18.3 mm

Mounting

Drive form screw head	Slotted (L)
-----------------------	-------------

Notes

Notes on operation	In accordance with IEC 61984, COMBICON connectors have no switching power (COC). During designated use, they must not be plugged in or disconnected when carrying voltage or under load.
--------------------	--

Mechanical tests

Test for conductor damage and slackening

Specification	IEC 60999-1:1999-11
Result	Test passed

Pull-out test

Specification	IEC 60999-1:1999-11
Conductor cross section/conductor type/tractive force setpoint/actual value	0.2 mm ² / solid / > 10 N
	0.2 mm ² / flexible / > 10 N
	2.5 mm ² / solid / > 50 N
	2.5 mm ² / flexible / > 50 N

Insertion and withdrawal forces

Result	Test passed
No. of cycles	100
Insertion strength per pos. approx.	6 N
Withdraw strength per pos. approx.	4 N

Torque test

Specification	IEC 60999-1:1999-11
---------------	---------------------

Resistance of inscriptions

Specification	IEC 60068-2-70:1995-12
Result	Test passed

Polarization and coding

Specification	IEC 60512-13-5:2006-02
Result	Test passed

MSTB 2,5/ 3-ST-5,08 BK AU - PCB connector



1765564

<https://www.phoenixcontact.com/pc/products/1765564>

Visual inspection

Specification	IEC 60512-1-1:2002-02
Result	Test passed

Dimension check

Specification	IEC 60512-1-2:2002-02
Result	Test passed

Environmental and real-life conditions

Vibration test

Specification	IEC 60068-2-6:2007-12
Frequency	10 - 500 - 10 Hz
Sweep speed	1 octave/min
Amplitude	0.35 mm (10 Hz ... 60.1 Hz)
Acceleration	5g (60.1 Hz ... 500 Hz)
Test duration per axis	2 h

Durability test

Specification	IEC 60512-9-1:2010-03
Impulse withstand voltage at sea level	4.8 kV
Contact resistance R ₁	2.8 mΩ
Contact resistance R ₂	2.8 mΩ
Contact resistance R ₂ 2nd level	1.6 mΩ
Insertion/withdrawal cycles	100
Insulation resistance, neighboring positions	> 5 MΩ

Climatic test

Specification	DIN 50018:2013-05
Corrosive stress	1.0 dm ³ SO ₂ on 300 dm ³ /40 °C/1 cycle
Thermal stress	100 °C/168 h
Power-frequency withstand voltage	2.21 kV

Ambient conditions

Ambient temperature (operation)	-40 °C ... 100 °C (dependent on the derating curve)
Ambient temperature (storage/transport)	-40 °C ... 70 °C
Relative humidity (storage/transport)	30 % ... 70 %
Ambient temperature (assembly)	-5 °C ... 100 °C

Electrical tests

Thermal test | Test group C

Specification	IEC 60512-5-1:2002-02
Tested number of positions	3

Insulation resistance

Specification	IEC 60512-3-1:2002-02
---------------	-----------------------

MSTB 2,5/ 3-ST-5,08 BK AU - PCB connector



1765564

<https://www.phoenixcontact.com/pc/products/1765564>

Insulation resistance, neighboring positions	> 5 MΩ
--	--------

Air clearances and creepage distances |

Specification	IEC 60664-1:2007-04
Insulating material group	I
Comparative tracking index (IEC 60112)	CTI 600
Rated insulation voltage (III/3)	250 V
Rated surge voltage (III/3)	4 kV
minimum clearance value - non-homogenous field (III/3)	3 mm
minimum creepage distance (III/3)	3.2 mm
Rated insulation voltage (III/2)	320 V
Rated surge voltage (III/2)	4 kV
minimum clearance value - non-homogenous field (III/2)	3 mm
minimum creepage distance (III/2)	3 mm
Rated insulation voltage (II/2)	630 V
Rated surge voltage (II/2)	4 kV
minimum clearance value - non-homogenous field (II/2)	3 mm
minimum creepage distance (II/2)	3.2 mm

Packaging specifications

Type of packaging	packed in cardboard
-------------------	---------------------

Drawings

Diagram

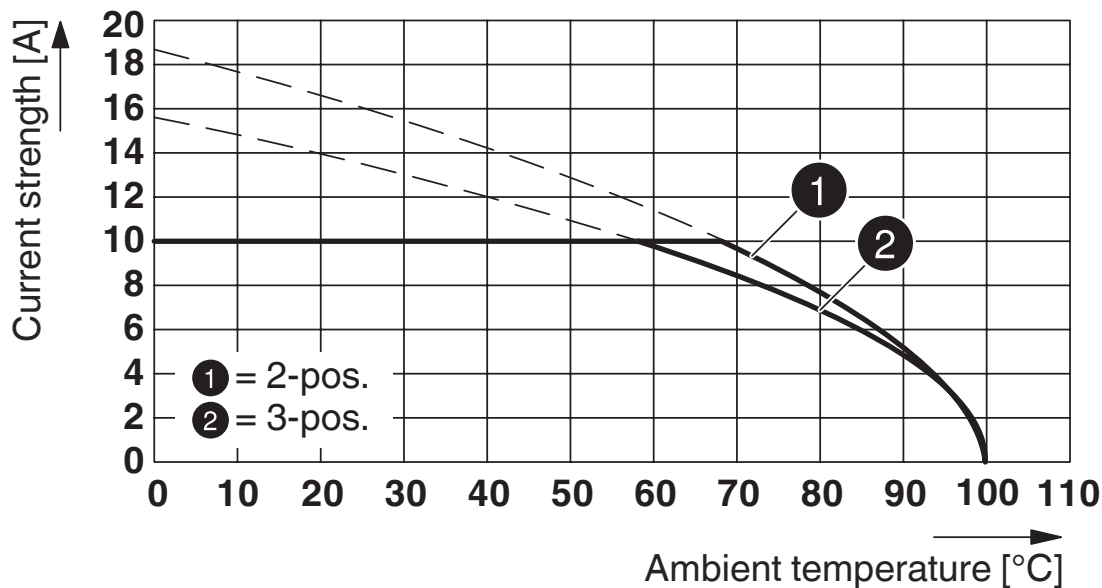

Type: MSTB 2,5/...-ST-5,08 AU with MDSTBV 2,5/...-G-5,08 AU

Diagram

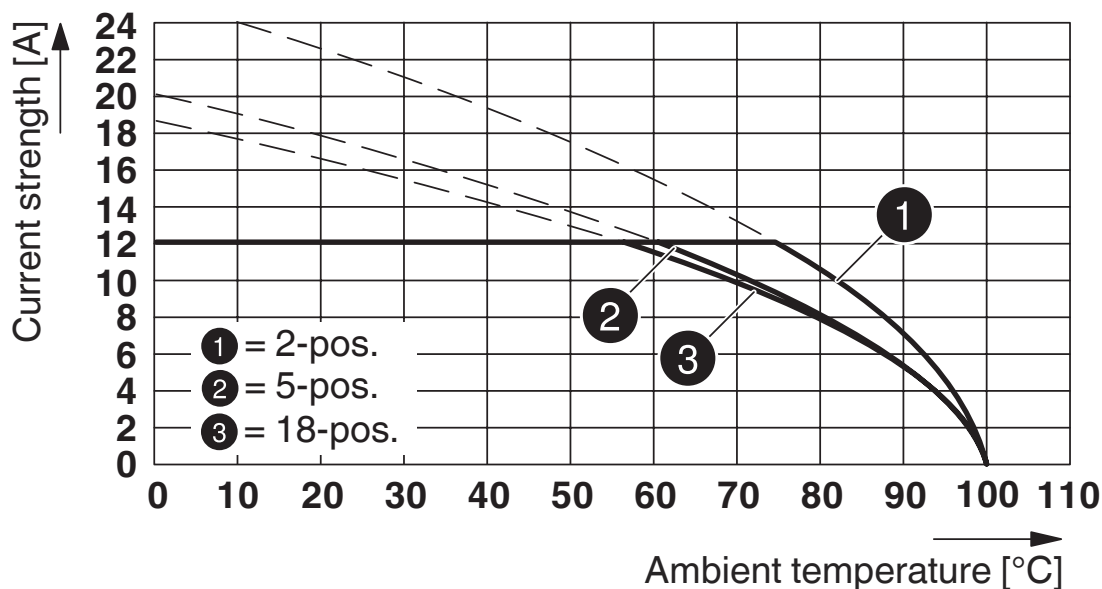

Type: MSTB 2,5/...-ST-5,08 AU with MSTBA 2,5/...-G-5,08 AU

MSTB 2,5/ 3-ST-5,08 BK AU - PCB connector



1765564

<https://www.phoenixcontact.com/pc/products/1765564>

Diagram

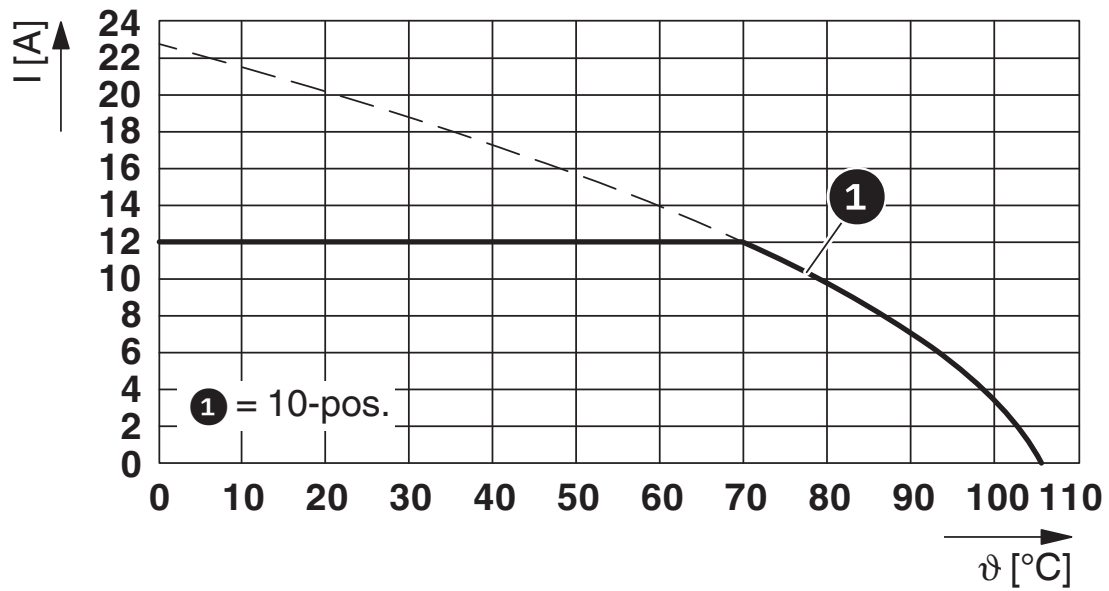

Type: MSTB 2,5/...-ST-5,08 AU with MSTBHK 2,5/...-G-5,08 AU

MSTB 2,5/ 3-ST-5,08 BK AU - PCB connector



1765564

<https://www.phoenixcontact.com/pc/products/1765564>

Approvals

To download certificates, visit the product detail page: <https://www.phoenixcontact.com/pc/products/1765564>

 cULus Recognized Approval ID: E60425-19931011				
	Nominal voltage U_N	Nominal current I_N	Cross section AWG	Cross section mm^2
Use group B	300 V	15 A	30 - 12	-
Use group D	300 V	10 A	30 - 12	-

 VDE Zeichengenehmigung Approval ID: 40050694				
	Nominal voltage U_N	Nominal current I_N	Cross section AWG	Cross section mm^2
	250 V	12 A	-	0.2 - 2.5

MSTB 2,5/ 3-ST-5,08 BK AU - PCB connector



1765564

<https://www.phoenixcontact.com/pc/products/1765564>

Classifications

ECLASS

ECLASS-11.0	27460202
ECLASS-12.0	27460202
ECLASS-13.0	27460202

ETIM

ETIM 8.0	EC002638
----------	----------

UNSPSC

UNSPSC 21.0	39121400
-------------	----------

MSTB 2,5/ 3-ST-5,08 BK AU - PCB connector



1765564

<https://www.phoenixcontact.com/pc/products/1765564>

Environmental product compliance

EU RoHS

Fulfills EU RoHS substance requirements	Yes, No exemptions
---	--------------------

China RoHS

Environment friendly use period (EFUP)	EFUP-E
	No hazardous substances above the limits

EU REACH SVHC

REACH candidate substance (CAS No.)	No substance above 0.1 wt%
-------------------------------------	----------------------------

MSTB 2,5/ 3-ST-5,08 BK AU - PCB connector

1765564

<https://www.phoenixcontact.com/pc/products/1765564>

Accessories

 Note: Applying some accessories below might limit this product.

EBP 2- 5 - Insertion bridge

1733169

<https://www.phoenixcontact.com/pc/products/1733169>

Insertion bridge for connectors with 5.0 mm or 5.08 mm pitch



 Max. current carrying capacity: 12 A

EBP 3- 5 - Insertion bridge

1733172

<https://www.phoenixcontact.com/pc/products/1733172>

Insertion bridge for connectors with 5.0 mm or 5.08 mm pitch



 Max. current carrying capacity: 12 A

MSTB 2,5/ 3-ST-5,08 BK AU - PCB connector

1765564

<https://www.phoenixcontact.com/pc/products/1765564>

EBP 4- 5 - Insertion bridge

1733185

<https://www.phoenixcontact.com/pc/products/1733185>



Insertion bridge for connectors with 5.0 mm or 5.08 mm pitch

 Max. current carrying capacity: 12 A

EBP 5- 5 - Insertion bridge

1733198

<https://www.phoenixcontact.com/pc/products/1733198>



Insertion bridge for connectors with 5.0 mm or 5.08 mm pitch

 Max. current carrying capacity: 12 A

MSTB 2,5/ 3-ST-5,08 BK AU - PCB connector



1765564

<https://www.phoenixcontact.com/pc/products/1765564>

EBP 6- 5 - Insertion bridge

1733208

<https://www.phoenixcontact.com/pc/products/1733208>

Insertion bridge for connectors with 5.0 mm or 5.08 mm pitch



 Max. current carrying capacity: 12 A

SZS 0,6X3,5 - Screwdriver

1205053

<https://www.phoenixcontact.com/pc/products/1205053>



Actuation tool, for ST terminal blocks, insulated, also suitable for use as a bladed screwdriver, size: 0.6 x 3.5 x 100 mm, 2-component grip, with non-slip grip

MSTB 2,5/ 3-ST-5,08 BK AU - PCB connector



1765564

<https://www.phoenixcontact.com/pc/products/1765564>

SK 5,08/3,8:FORTL.ZAHLEN - Marker card

0804293

<https://www.phoenixcontact.com/pc/products/0804293>

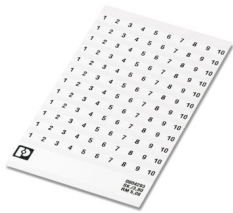

Marker card, white, labeled, horizontal: consecutive numbers 1 ... 10, 11 ... 20, etc. up to 91 ... (99)100, mounting type: adhesive, for terminal block width: 5.08 mm, lettering field size: 5.08 x 3.8 mm

KGG-MSTB 2,5/ 3 - Cable housing

1803947

<https://www.phoenixcontact.com/pc/products/1803947>



Cable housing, color: green, product range: KGG-MSTB 2,5, width: 19 mm

MSTB 2,5/ 3-ST-5,08 BK AU - PCB connector

1765564

<https://www.phoenixcontact.com/pc/products/1765564>

CP-MSTB - Coding profile

1734634

<https://www.phoenixcontact.com/pc/products/1734634>

Coding profile, is inserted into the slot on the plug or inverted header, red insulating material



UKK 3-MSTBVH-5,08 - Double-level terminal block

2770846

<https://www.phoenixcontact.com/pc/products/2770846>



Double-level terminal block, nom. voltage: 250 V, nominal current: 12 A, number of connections: 4, number of positions: 1, connection method: Screw/plug-in connection, 1st and 2nd level connection left, cross section: 0.2 mm² - 4 mm², mounting type: NS 35/7,5, NS 35/15, NS 32, color: gray

MSTB 2,5/ 3-ST-5,08 BK AU - PCB connector

1765564

<https://www.phoenixcontact.com/pc/products/1765564>

UK 3-MVSTB-5,08 - Feed-through terminal block

3002076

<https://www.phoenixcontact.com/pc/products/3002076>

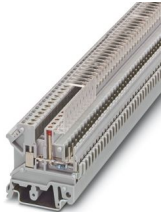

Feed-through terminal block, nom. voltage: 250 V, nominal current: 12 A, number of connections: 2, number of positions: 1, connection method: Screw/plug-in connection, 1st level connection left, cross section: 0.2 mm² - 4 mm², mounting type: NS 32, NS 35/15, NS 35/7,5, color: gray

MDSTBA 2,5/ 3-G-5,08 - PCB header

1842076

<https://www.phoenixcontact.com/pc/products/1842076>

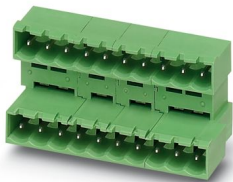

PCB headers, nominal cross section: 2.5 mm², color: green, nominal current: 10 A, rated voltage (III/2): 320 V, contact surface: Tin, contact connection type: Pin, number of potentials: 6, number of rows: 2, number of positions: 3, number of connections: 6, product range: MDSTBA 2,5/..-G, pitch: 5.08 mm, mounting: Wave soldering, pin layout: Linear pinning, solder pin [P]: 3.23 mm, number of solder pins per potential: 1, plug-in system: COMBICON MSTB 2,5, Pin connector pattern alignment: Standard, locking: without, mounting: without, type of packaging: packed in cardboard, The article can be aligned to create different nos. of positions! In combination with MVSTB or FKCV plug components, both an MVSTBW (or FKCVW) and an MVSTBR plug (or FKCVR) must be used. Combination with TMSTBP plug components is not possible!

MSTB 2,5/ 3-ST-5,08 BK AU - PCB connector

1765564

<https://www.phoenixcontact.com/pc/products/1765564>

FKIC 2,5/ 3-ST-5,08 - PCB connector

1873362

<https://www.phoenixcontact.com/pc/products/1873362>

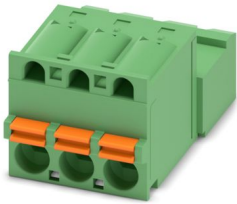

PCB connector, nominal cross section: 2.5 mm², color: green, nominal current: 12 A, rated voltage (III/2): 320 V, contact surface: Tin, contact connection type: Pin, number of potentials: 3, number of rows: 1, number of positions: 3, number of connections: 3, product range: FKIC 2,5/...-ST, pitch: 5.08 mm, connection method: Push-in spring connection, conductor/PCB connection direction: 0 °, locking clip: - without locking clip, plug-in system: COMBICON MSTB 2,5, locking: without, mounting: without, type of packaging: packed in cardboard

MDSTB 2,5/ 3-G1-5,08 - PCB header

1762376

<https://www.phoenixcontact.com/pc/products/1762376>

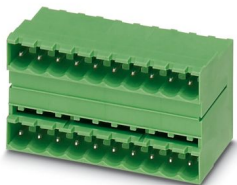

PCB headers, nominal cross section: 2.5 mm², color: green, nominal current: 10 A, rated voltage (III/2): 320 V, contact surface: Tin, contact connection type: Pin, number of potentials: 6, number of rows: 2, number of positions: 3, number of connections: 6, product range: MDSTB 2,5/...-G1, pitch: 5.08 mm, mounting: Wave soldering, pin layout: Linear pinning, solder pin [P]: 3.3 mm, number of solder pins per potential: 1, plug-in system: COMBICON MSTB 2,5, Pin connector pattern alignment: Standard, locking: without, mounting: without, type of packaging: packed in cardboard, In combination with MVSTB or FKCV plug components, both an MVSTBW (or FKCVW) and an MVSTBR plug (or FKCVR) must be used. Combination with TMSTBP plug components is not possible!

MSTB 2,5/ 3-ST-5,08 BK AU - PCB connector



1765564

<https://www.phoenixcontact.com/pc/products/1765564>

MDSTB 2,5/ 3-G-5,08 - PCB header

1762075

<https://www.phoenixcontact.com/pc/products/1762075>

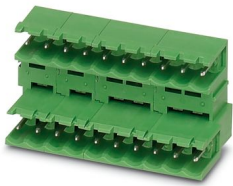

PCB headers, nominal cross section: 2.5 mm², color: green, nominal current: 10 A, rated voltage (III/2): 320 V, contact surface: Tin, contact connection type: Pin, number of potentials: 6, number of rows: 2, number of positions: 3, number of connections: 6, product range: MDSTB 2,5/..-G, pitch: 5.08 mm, mounting: Wave soldering, pin layout: Linear pinning, solder pin [P]: 3.23 mm, number of solder pins per potential: 1, plug-in system: COMBICON MSTB 2,5, Pin connector pattern alignment: Standard, locking: without, mounting: without, type of packaging: packed in cardboard, Can be aligned! Mounting flange: Item No. 1736771, 1736768. In combination with MVSTB or FKCV plugs, both an MVSTBW (or FKCVW) and an MVSTBR plug (or FKCVR) must be used. Combination with TMSTBP plugs is not possible!

SMSTBA 2,5/ 3-G-5,08 - PCB header

1767384

<https://www.phoenixcontact.com/pc/products/1767384>



PCB headers, nominal cross section: 2.5 mm², color: green, nominal current: 12 A, rated voltage (III/2): 320 V, contact surface: Tin, contact connection type: Pin, number of potentials: 3, number of rows: 1, number of positions: 3, number of connections: 3, product range: SMSTBA 2,5/..-G, pitch: 5.08 mm, mounting: Wave soldering, pin layout: Linear pinning, solder pin [P]: 3.5 mm, number of solder pins per potential: 1, plug-in system: COMBICON MSTB 2,5, Pin connector pattern alignment: Standard, locking: without, mounting: without, type of packaging: packed in cardboard

MSTB 2,5/ 3-ST-5,08 BK AU - PCB connector



1765564

<https://www.phoenixcontact.com/pc/products/1765564>

SMSTB 2,5/ 3-G-5,08 - PCB header

1769476

<https://www.phoenixcontact.com/pc/products/1769476>



PCB headers, nominal cross section: 2.5 mm², color: green, nominal current: 12 A, rated voltage (III/2): 320 V, contact surface: Tin, contact connection type: Pin, number of potentials: 3, number of rows: 1, number of positions: 3, number of connections: 3, product range: SMSTB 2,5/..-G, pitch: 5.08 mm, mounting: Wave soldering, pin layout: Linear pinning, solder pin [P]: 3.5 mm, number of solder pins per potential: 1, plug-in system: COMBICON MSTB 2,5, Pin connector pattern alignment: Standard, locking: without, mounting: without, type of packaging: packed in cardboard

ICC 2,5/ 3-STZ-5,08 - PCB connector

1823859

<https://www.phoenixcontact.com/pc/products/1823859>



PCB connector, nominal cross section: 2.5 mm², color: green, nominal current: 12 A, rated voltage (III/2): 320 V, contact connection type: Pin, number of potentials: 3, number of rows: 1, number of positions: 3, number of connections: 3, product range: ICC 2,5/..-STZ, pitch: 5.08 mm, connection method: Crimp connection, conductor/PCB connection direction: 0 °, locking clip: - without locking clip, plug-in system: COMBICON MSTB 2,5, locking: Snap-in locking, mounting: Engagement nose, type of packaging: packed in cardboard, Corresponding male crimp contacts with current [A] and conductor cross section range [mm²] data: 10A/ICC-MT 0,5-1,0 (3190577); 10A/ICC-MT 0,5-1,0 BA (3190603); 12A/ICC-MT 1,5-2,5 (3190580); 12A/ICC-MT 1,5-2,5 BA (3190593). BA = Bandkontakte

Phoenix Contact 2024 © - all rights reserved

<https://www.phoenixcontact.com>

PHOENIX CONTACT GmbH & Co. KG

Flachsmarktstraße 8

D-32825 Blomberg

+49 (0) 5235-3 00

info@phoenixcontact.com