

SACC-M 8MS-4QO-0,5-M - Connector



1441037

<https://www.phoenixcontact.com/il/products/1441037>

Please be informed that the data shown in this PDF document is generated from our online catalog. Please find the complete data in the user documentation. Our general terms of use for downloads are valid.



Connector, Universal, 4-position, Plug straight M8, coding: A, Insulation displacement connection, knurl material: Zinc die-cast, nickel-plated, external cable diameter 2.5 mm ... 5 mm

Your advantages

- Safe use in the field, thanks to a high degree of protection
- Insulation displacement connection: innovative and time-saving assembly without stripping the single wire

Commercial data

Item number	1441037
Packing unit	1 pc
Minimum order quantity	1 pc
Product key	BF2BCA
Catalog page	Page 16 (C-2-2019)
GTIN	4046356515924
Weight per piece (including packing)	8.2 g
Weight per piece (excluding packing)	8.3 g
Customs tariff number	85366990
Country of origin	DE

SACC-M 8MS-4QO-0,5-M - Connector

1441037

<https://www.phoenixcontact.com/il/products/1441037>

Technical data

Notes

Assembly instruction:

NOTE: Observe the permissible bending radii when laying conductors, since the degree of protection may be put in jeopardy if the bending forces are too high. Alleviate mechanical loads upstream of the connector, e.g. by using cable ties.

Product properties

Product type	Circular connector (cable-side)
Sensor type	Universal
Number of positions	4
No. of cable outlets	1
Shielded	no
Coding	A
Cable outlet	straight

Insulation characteristics

Overvoltage category	II
Degree of pollution	3

Dimensions

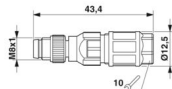
Dimensional drawing	
Length	43.4 mm

External dimensions

Outside diameter	2.5 mm ... 5 mm ±0.2 mm
------------------	-------------------------

Housing

Diameter housing	12.5 mm
------------------	---------

Material specifications

Flammability rating according to UL 94	HB
Seal material	NBR
Material of grip body	PA 6
Contact material	CuSn
Contact surface material	Ni/Au
Contact carrier material	TPU GF
Material for screw connection	Zinc die-cast, nickel-plated
Wire insulation material	PVC / PE / PP / rubber

SACC-M 8MS-4QO-0,5-M - Connector



1441037

<https://www.phoenixcontact.com/il/products/1441037>

Connection data

Conductor connection

Connection method	Insulation displacement connection
Connection cross section	0.25 mm ² ... 0.5 mm ²
Connection cross section AWG	24 ... 20
Tightening torque	0.6 Nm (Pressure nut) 0.2 Nm (M8 knurl)

Pin assignment

Contact Color (signal designation) Contact (optional)	1 = BN
	2 = WH
	3 = BU
	4 = BK

Electrical properties

Rated surge voltage	0.8 kV
Contact resistance	≤ 5 mΩ
Insulation resistance	≥ 100 MΩ
Nominal voltage U _N	30 V AC 30 V DC
Nominal current I _N	4 A

Mechanical properties

Mechanical data

Insertion/withdrawal cycles	≥ 100
-----------------------------	-------

Connector

Connection 1

Head design	Plug
Head cable outlet	straight
Head thread type	M8
Coding	A

Cable/line

Signal type/category	Universal
External cable diameter	2.5 mm ... 5 mm

Environmental and real-life conditions

Ambient conditions

Degree of protection	IP65 IP67
Ambient temperature (operation)	-25 °C ... 80 °C (Plug / socket)

SACC-M 8MS-4QO-0,5-M - Connector



1441037

<https://www.phoenixcontact.com/il/products/1441037>

Standards and regulations

M8

Standard designation	M8 connector
Standards/specifications	IEC 61076-2-104

SACC-M 8MS-4QO-0,5-M - Connector

1441037

<https://www.phoenixcontact.com/il/products/1441037>

Drawings

Schematic diagram

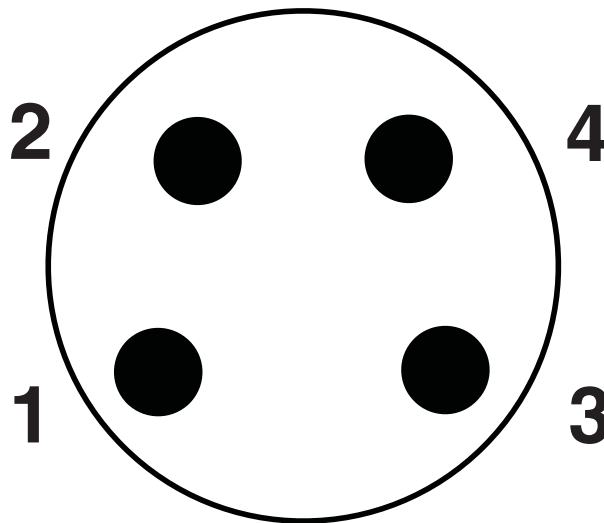

Pin assignment M8 plug, 4-pos., view male side

Dimensional drawing

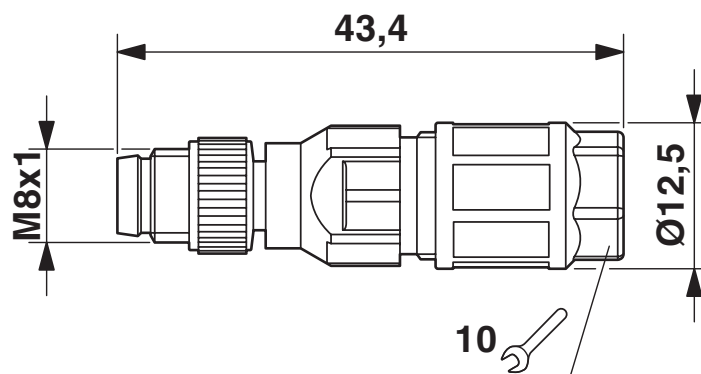

M8 x 1 male plug, straight version

SACC-M 8MS-4QO-0,5-M - Connector

1441037

<https://www.phoenixcontact.com/il/products/1441037>

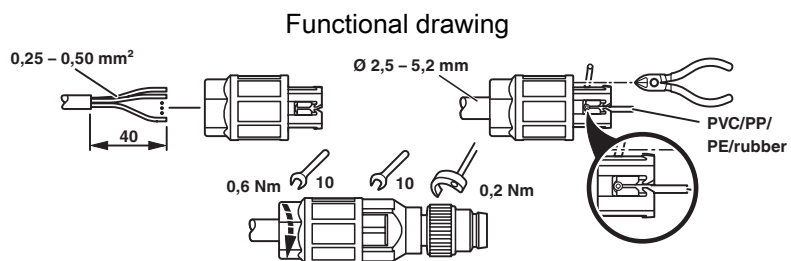

SACC-M 8MS-4QO-0,5-M - Connector





1441037

<https://www.phoenixcontact.com/il/products/1441037>

Approvals

To download certificates, visit the product detail page: <https://www.phoenixcontact.com/il/products/1441037>

 cUL Recognized Approval ID: FILE E 118976				
	Nominal voltage U_N	Nominal current I_N	Cross section AWG	Cross section mm^2
	29 V	4 A	24 - 20	-

 UL Recognized Approval ID: FILE E 118976				
	Nominal voltage U_N	Nominal current I_N	Cross section AWG	Cross section mm^2
	29 V	4 A	24 - 20	-

 EAC Approval ID: RU C-DE.AI30.B.01102				
--	--	--	--	--

 EAC Approval ID: EAC-Zulassung				
--	--	--	--	--

 EAC Approval ID: RU C-DE.BL08.B.00511				
---	--	--	--	--

cULus Recognized				
-------------------------	--	--	--	--

SACC-M 8MS-4QO-0,5-M - Connector



1441037

<https://www.phoenixcontact.com/il/products/1441037>

Classifications

ECLASS

ECLASS-11.0	27440102
ECLASS-12.0	27440116
ECLASS-13.0	27440116

ETIM

ETIM 9.0	EC002635
----------	----------

UNSPSC

UNSPSC 21.0	39121400
-------------	----------

SACC-M 8MS-4QO-0,5-M - Connector



1441037

<https://www.phoenixcontact.com/il/products/1441037>

Environmental product compliance

EU RoHS

Fulfills EU RoHS substance requirements	Yes, No exemptions
---	--------------------

China RoHS

Environment friendly use period (EFUP)	EFUP-E
	No hazardous substances above the limits

EU REACH SVHC

REACH candidate substance (CAS No.)	No substance above 0.1 wt%
-------------------------------------	----------------------------

Phoenix Contact 2024 © - all rights reserved
<https://www.phoenixcontact.com>

PHOENIX CONTACT Israel Ltd.
P.O.B. 1799 Industrial Park Hasharon
Quadima 60920
+972-9-8915700
info@phoenixcontact.co.il