

# SAC-5P-MS/20,0-923/FR CAN SCO - Bus system cable



1419072

<https://www.phoenixcontact.com/pc/products/1419072>

Please be informed that the data shown in this PDF document is generated from our online catalog. Please find the complete data in the user documentation. Our general terms of use for downloads are valid.



Bus system cable, CANopen®, DeviceNet™, 5-position, PUR halogen-free, silver-grey RAL 7001, shielded, Plug straight M12 SPEEDCON, coding: A, on Socket angled M12 SPEEDCON, coding: A, cable length: 20 m, Connector unshielded

## Commercial data

Item number	1419072
Packing unit	1 pc
Minimum order quantity	1 pc
Product key	BF1CDD
Catalog page	Page 431 (C-2-2019)
GTIN	4046356543330
Weight per piece (including packing)	1,209 g
Weight per piece (excluding packing)	1,209 g
Customs tariff number	85444290
Country of origin	PL

# SAC-5P-MS/20,0-923/FR CAN SCO - Bus system cable



1419072

<https://www.phoenixcontact.com/pc/products/1419072>

## Technical data

### Product properties

Product type	Data cable preassembled
Application	Standard
Sensor type	CANopen®
Number of positions	5
No. of cable outlets	1
Coding	A

### Insulation characteristics

Overvoltage category	II
Degree of pollution	3

### Interfaces

Bus system	CANopen®/DeviceNet™
Signal type/category	CANopen® DeviceNet™

### Signaling

Status display	no
Status display present	No

### Electrical properties

Nominal voltage $U_N$	48 V AC
	60 V DC
Nominal current $I_N$	4 A
Transmission medium	Copper

### Material specifications

Flammability rating according to UL 94	HB
Seal material	NBR
Material of grip body	TPU, hardly inflammable, self-extinguishing
Contact material	CuSn
Contact surface material	Ni/Au
Contact carrier material	TPU GF
Material for screw connection	Zinc die-cast, nickel-plated

### Connection data

#### Pin assignment

Contact   Color (signal designation)   Contact (optional)	1 (Plug)   SR (shield)   1 (Socket)
	2 (Plug)   RD (V+)   2 (Socket)
	3 (Plug)   BK (V-)   3 (Socket)
	4 (Plug)   WH (CAN_H)   4 (Socket)

# SAC-5P-MS/20,0-923/FR CAN SCO - Bus system cable



1419072

<https://www.phoenixcontact.com/pc/products/1419072>

	5 (Plug)   BU (CAN_L)   5 (Socket)
--	------------------------------------

## Connector

### Connection 1

Type	Plug straight M12 SPEEDCON
Number of positions	5
Locking type	SPEEDCON
Coding type	A (Standard)
Ambient temperature (operation)	-25 °C ... 90 °C

### Connection 2

Type	Socket angled M12 SPEEDCON
Number of positions	5
Locking type	SPEEDCON
Coding type	A (Standard)
Ambient temperature (operation)	-25 °C ... 90 °C

## Cable/line

Cable length	20 m
--------------	------

### CANopen®/DeviceNet™, PUR, gray [923]

Dimensional drawing	
Cable weight	90 kg/km
UL AWM Style	21198 (80°C/300 V)
Number of positions	4
Shielded	yes
Cable type	CANopen®/DeviceNet™, PUR, gray [923]
Conductor structure	2xAWG24/19+2xAWG22/19
Conductor structure signal line	19x 0.13 mm
AWG signal line	24
Conductor cross section	2x 0.25 mm <sup>2</sup> (Data cable) 2x 0.34 mm <sup>2</sup> (Power supply) 1x 0.34 mm <sup>2</sup> (Drain wire)
Wire diameter incl. insulation	1.95 mm ±0.05 mm (Data cable) 1.4 mm ±0.05 mm (Power supply)
External cable diameter	6.70 mm ±0.3 mm
Outer sheath, material	PUR

# SAC-5P-MS/20,0-923/FR CAN SCO - Bus system cable



1419072

<https://www.phoenixcontact.com/pc/products/1419072>

External sheath, color	silver-grey RAL 7001
Conductor material	Tin-plated Cu litz wires
Material wire insulation	Foamed PE (Data cable)
	PE (Power supply)
Single wire, color	red-black, blue-white
Twisted pairs	2 cores to the pair
Type of pair shielding	Plastic-coated aluminum foil, aluminum side outside
Overall twist	2 pairs around a drain wire in the center to the core
Optical shield covering	80 %
Insulation resistance	≥ 5 GΩ*km (Data cable)
	≥ 5 GΩ*km (Power supply)
Loop resistance	≤ 181.80 Ω/km (Data cable)
	≤ 114.80 Ω/km (Power supply)
Wave impedance	120 Ω ±10 % (with 1 MHz)
Cable capacity	nom. 40 nF/km (Data cable)
Nominal voltage, cable	≤ 300 V (Peak value, not for high-power applications)
Test voltage Core/Core	2000 V (50 Hz, 1 min.)
Test voltage Core/Shield	2000.00 V (50 Hz, 1 min.)
Minimum bending radius, fixed installation	5 x D
Minimum bending radius, flexible installation	10 x D
Smallest bending radius, fixed installation	34 mm
Smallest bending radius, movable installation	67 mm
Max. bending cycles	5000000
Minimum bending radius, drag chain applications	10 x D
Bending radius	70 mm
Traversing path	4.5 m
Traversing rate	3 m/s
Acceleration	3 m/s <sup>2</sup>
Shield attenuation	≤ 22.9 dB/km (with 1 MHz)
	≤ 16.4 dB/km (At 500 kHz)
	≤ 9.5 dB/km (At 125 kHz)
Halogen-free	in accordance with DIN VDE 0472 part 815
	according to IEC 60754-1
Flame resistance	UL 1581, Sec. 1060 (FT-1)
	IEC 60332-1
Other resistance	Low adhesion
Ambient temperature (operation)	-40 °C ... 80 °C (cable, fixed installation)
	-20 °C ... 80 °C (Cable, flexible installation)
	≤ 70 °C (cable, drag chain applications)

## Environmental and real-life conditions

### Ambient conditions

Degree of protection	IP65
----------------------	------

# SAC-5P-MS/20,0-923/FR CAN SCO - Bus system cable



1419072

<https://www.phoenixcontact.com/pc/products/1419072>

	IP67
Ambient temperature (operation)	-25 °C ... 90 °C (Plug / socket)

# SAC-5P-MS/20,0-923/FR CAN SCO - Bus system cable

1419072

<https://www.phoenixcontact.com/pc/products/1419072>

## Drawings

Circuit diagram

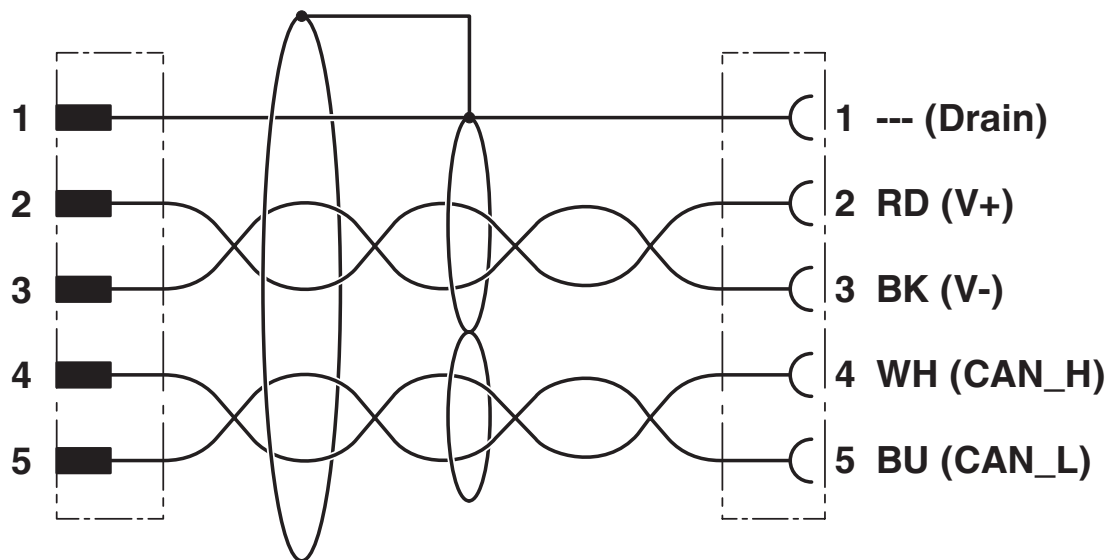

Schematic diagram

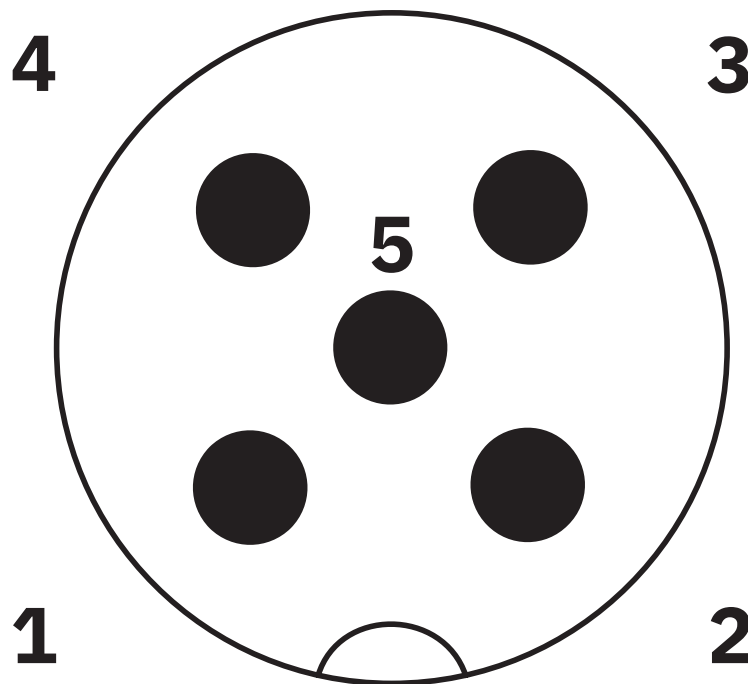

Pin assignment M12 male connector, 5-pos., A-coded, male side

# SAC-5P-MS/20,0-923/FR CAN SCO - Bus system cable

1419072

<https://www.phoenixcontact.com/pc/products/1419072>

Dimensional drawing

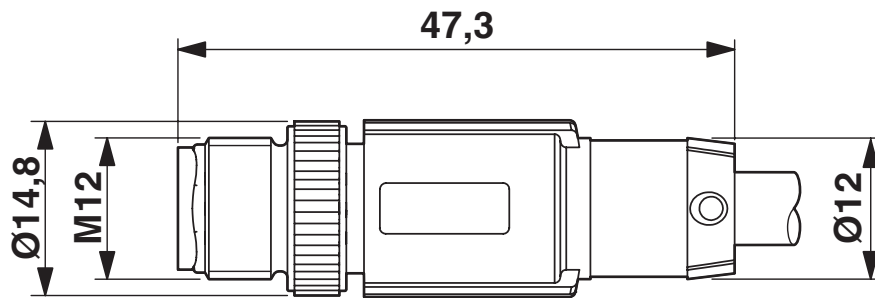

Plug, M12 x 1, straight, shielded

Dimensional drawing

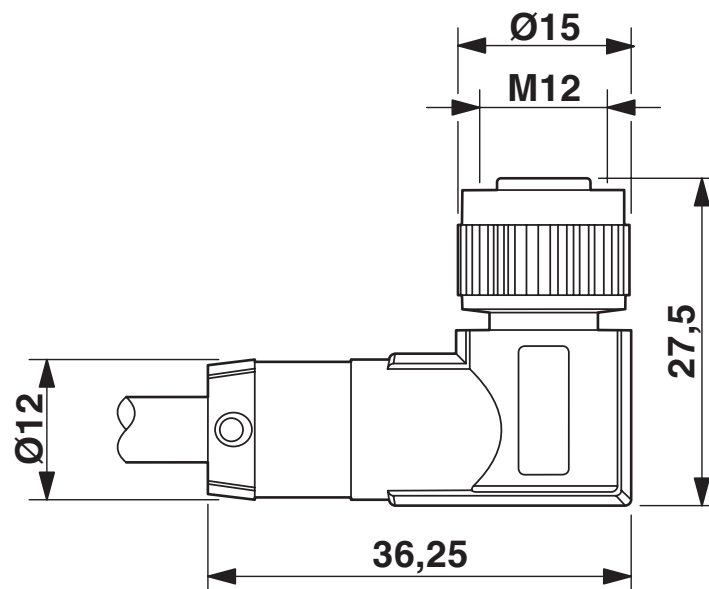

M12 x 1 socket, angled

# SAC-5P-MS/20,0-923/FR CAN SCO - Bus system cable

1419072

<https://www.phoenixcontact.com/pc/products/1419072>

Schematic diagram

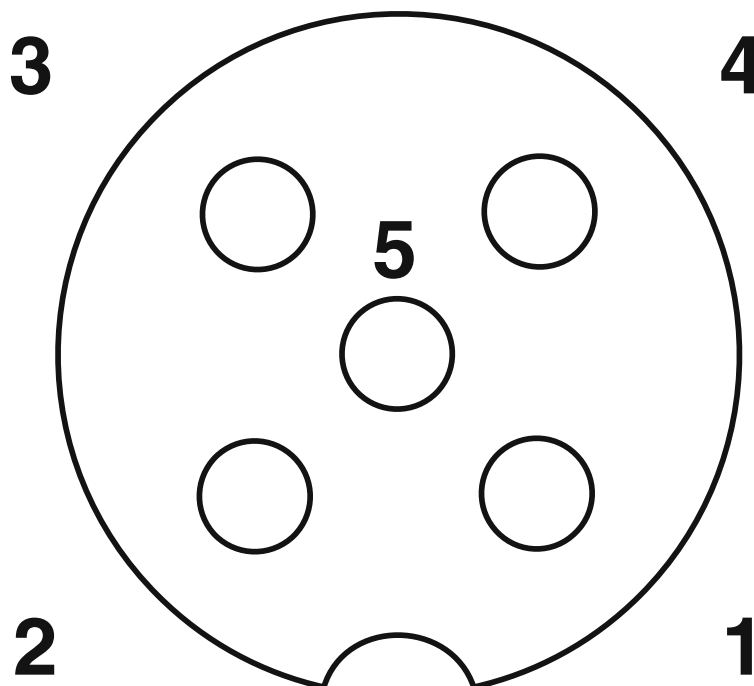

Pin assignment M12 socket, 5-pos., A-coded, socket side view



# SAC-5P-MS/20,0-923/FR CAN SCO - Bus system cable





1419072

<https://www.phoenixcontact.com/pc/products/1419072>

## Approvals

To download certificates, visit the product detail page: <https://www.phoenixcontact.com/pc/products/1419072>

 <b>UL Listed</b> Approval ID: FILE E 221474				
	Nominal voltage $U_N$	Nominal current $I_N$	Cross section AWG	Cross section $\text{mm}^2$
	125 V	4 A	-	-

 <b>cUL Listed</b> Approval ID: FILE E 221474				
	Nominal voltage $U_N$	Nominal current $I_N$	Cross section AWG	Cross section $\text{mm}^2$
	125 V	4 A	-	-

 <b>EAC-RoHS</b> Approval ID: RU D-DE.HB35.B.00387	
---	--

<b>cULus Listed</b>
---------------------

# SAC-5P-MS/20,0-923/FR CAN SCO - Bus system cable



1419072

<https://www.phoenixcontact.com/pc/products/1419072>

## Classifications

### ECLASS

ECLASS-11.0	27060307
ECLASS-12.0	27060307
ECLASS-13.0	27060307

### ETIM

ETIM 9.0	EC001855
----------	----------

### UNSPSC

UNSPSC 21.0	26121600
-------------	----------

# SAC-5P-MS/20,0-923/FR CAN SCO - Bus system cable



1419072

<https://www.phoenixcontact.com/pc/products/1419072>

## Environmental product compliance

### EU RoHS

Fulfills EU RoHS substance requirements	Yes, No exemptions
---	--------------------

### China RoHS

Environment friendly use period (EFUP)	EFUP-E
	No hazardous substances above the limits

### EU REACH SVHC

REACH candidate substance (CAS No.)	No substance above 0.1 wt%
-------------------------------------	----------------------------

Phoenix Contact 2024 © - all rights reserved  
<https://www.phoenixcontact.com>

PHOENIX CONTACT GmbH & Co. KG  
Flachmarktstraße 8  
D-32825 Blomberg  
+49 (0) 5235-3 00  
[info@phoenixcontact.com](mailto:info@phoenixcontact.com)