

SAC-8P-M 8MR/ 5,0-PUR - Sensor/actuator cable



1404185

<https://www.phoenixcontact.com/us/products/1404185>

Please be informed that the data shown in this PDF document is generated from our online catalog. Please find the complete data in the user documentation. Our general terms of use for downloads are valid.

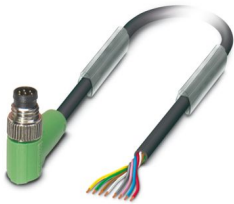

Sensor/actuator cable, 8-position, PUR halogen-free, black-gray RAL 7021, Plug angled M8, coding: A, on free cable end, cable length: 5 m

Your advantages

- Easy and safe: 100 % electrically tested plug-in components
- Save space – with high-pos. connectors

Commercial data

Item number	1404185
Packing unit	1 pc
Minimum order quantity	1 pc
Note	Made to order (non-returnable)
Sales key	BF01
Product key	BF1BGA
Catalog page	Page 207 (C-2-2019)
GTIN	4046356681070
Weight per piece (including packing)	164.2 g
Weight per piece (excluding packing)	164 g
Customs tariff number	85444290
Country of origin	PL

1404185

<https://www.phoenixcontact.com/us/products/1404185>

Technical data

Product properties

Product type	Sensor/actuator cable
Application	Standard
Number of positions	8
No. of cable outlets	1
Shielded	no
Coding	A

Insulation characteristics

Degree of pollution	3
---------------------	---

Material specifications

Flammability rating according to UL 94	HB
Material of grip body	TPU, hardly inflammable, self-extinguishing
Contact material	CuSn
Contact surface material	Ni/Au
Contact carrier material	TPU GF
Material for screw connection	Zinc die-cast, nickel-plated

Electrical properties

Insulation resistance	≥ 100 MΩ
Nominal voltage U_N	30 V AC
	30 V DC
Nominal current I_N	1.5 A

Mechanical properties

Mechanical data

Insertion/withdrawal cycles	≥ 100
-----------------------------	-------

Signaling

Status display	No
Status display present	No

Connection data

Conductor connection

Tightening torque	0.2 Nm (M8 connectors)
-------------------	------------------------

Connector

Connection 1

Type	Plug angled M8
Number of positions	8

SAC-8P-M 8MR/ 5,0-PUR - Sensor/actuator cable



1404185

<https://www.phoenixcontact.com/us/products/1404185>

Coding type	A
-------------	---

Connection 2

Type	free cable end
------	----------------

Cable/line

Cable length	5 m
--------------	-----

PUR halogen-free black [PUR]

Dimensional drawing	
Cable weight	31.4 kg/km
UL AWM Style	20549
Number of positions	8
Shielded	no
Cable type	PUR halogen-free black [PUR]
Conductor structure signal line	18x 0.10 mm
AWG signal line	26
Conductor cross section	8x 0.14 mm ² (Signal line)
Wire diameter incl. insulation	1 mm ±0.02 mm (Signal line)
External cable diameter	5.10 mm ±0.15 mm
Outer sheath, material	PUR
External sheath, color	black-gray RAL 7021
Conductor material	Bare Cu litz wires
Material, filler	PE
Material wire insulation	PP
Single wire, color	white, brown, green, yellow, gray, pink, blue, red
Thickness, insulation	≥ 0.21 mm (Signal line) ≥ 0.38 mm (Outer cable sheath)
Overall twist	8 wires around filler to the core
Length of twist, overall twist	58 mm
Max. conductor resistance	139 Ω/km (at 20 °C)
Insulation resistance	1 GΩ*km (at 20 °C)
Nominal voltage, cable	≤ 300 V AC
Test voltage	≥ 3000 V AC (Spark test)
Minimum bending radius, fixed installation	5 x D
Minimum bending radius, flexible installation	10 x D
Smallest bending radius, fixed installation	25.5 mm
Smallest bending radius, movable installation	51 mm

SAC-8P-M 8MR/ 5,0-PUR - Sensor/actuator cable



1404185

<https://www.phoenixcontact.com/us/products/1404185>

Max. bending cycles	4000000
Halogen-free	in accordance with DIN VDE 0472 part 815
	in accordance with DIN EN 50267-2-1
Flame resistance	according to UL 758/1581 (horizontal)
	in accordance with UL 758/1581 FT2
Resistance to oil	According to DIN EN 60811-2-1, 168 h at 100°C
Other resistance	hydrolysis and microbe resistant
	Resistant to salt water
	Low adhesion
	abrasion-resistant
Ambient temperature (operation)	partly UV-resistant (in accordance with DIN EN ISO 4892-2-A)
	-40 °C ... 80 °C (cable, fixed installation)
	-25 °C ... 80 °C (Cable, flexible installation)

Environmental and real-life conditions

Ambient conditions

Degree of protection	IP65
	IP67
	IP68
Ambient temperature (operation)	-25 °C ... 85 °C (Plug / socket)

Standards and regulations

M8

Standard designation	M8 connector
Standards/specifications	IEC 61076-2-104

SAC-8P-M 8MR/ 5,0-PUR - Sensor/actuator cable



1404185

<https://www.phoenixcontact.com/us/products/1404185>

Drawings

Dimensional drawing

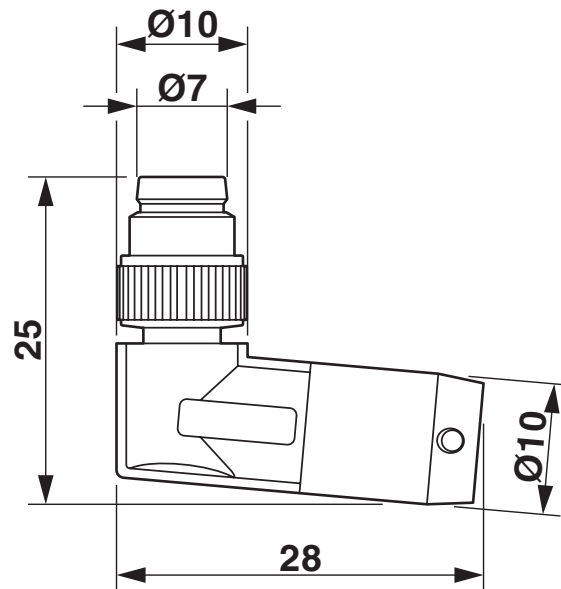

M8 x 1 male plug, angled version

Circuit diagram

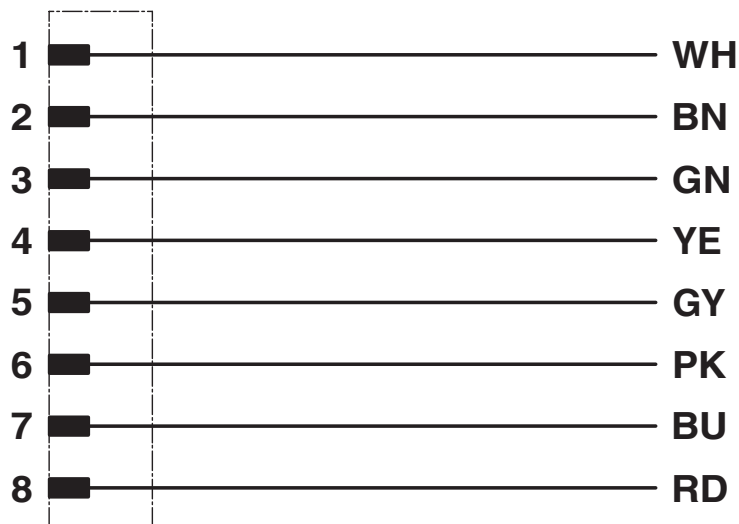

1404185

<https://www.phoenixcontact.com/us/products/1404185>

Schematic diagram

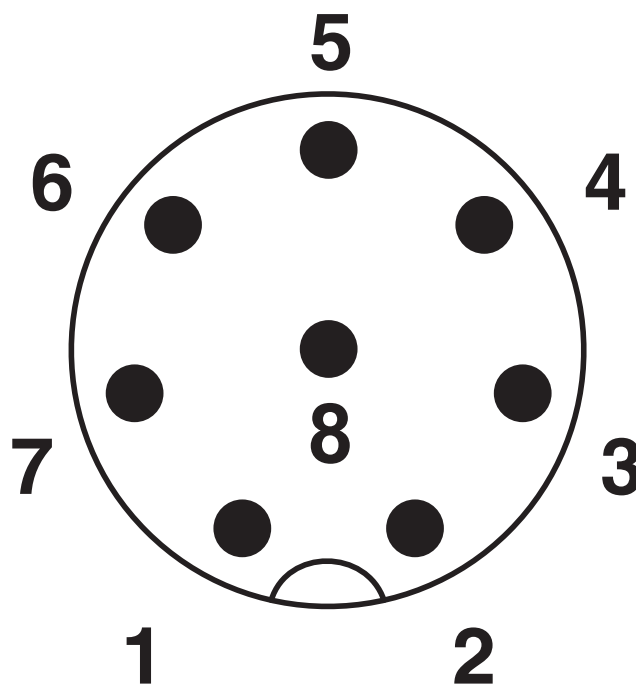

M8 plug pin assignment, 8-pos., view of pin side

SAC-8P-M 8MR/ 5,0-PUR - Sensor/actuator cable





1404185

<https://www.phoenixcontact.com/us/products/1404185>

Approvals

To download certificates, visit the product detail page: <https://www.phoenixcontact.com/us/products/1404185>

 UL Listed Approval ID: FILE E 221474	Nominal voltage U_N	Nominal current I_N	Cross section AWG	Cross section mm^2
	30 V	1.5 A	-	-

 cUL Listed Approval ID: FILE E 221474	Nominal voltage U_N	Nominal current I_N	Cross section AWG	Cross section mm^2
	30 V	1.5 A	-	-

 EAC-RoHS Approval ID: RU D-DE.HB35.B.00387

cULus Listed

SAC-8P-M 8MR/ 5,0-PUR - Sensor/actuator cable



1404185

<https://www.phoenixcontact.com/us/products/1404185>

Classifications

ECLASS

ECLASS-11.0	27060311
ECLASS-12.0	27060311
ECLASS-13.0	27060311

ETIM

ETIM 9.0	EC001855
----------	----------

UNSPSC

UNSPSC 21.0	26121600
-------------	----------

SAC-8P-M 8MR/ 5,0-PUR - Sensor/actuator cable



1404185

<https://www.phoenixcontact.com/us/products/1404185>

Environmental product compliance

EU RoHS

Fulfills EU RoHS substance requirements	Yes, No exemptions
---	--------------------

China RoHS

Environment friendly use period (EFUP)	EFUP-E
	No hazardous substances above the limits

EU REACH SVHC

REACH candidate substance (CAS No.)	No substance above 0.1 wt%
-------------------------------------	----------------------------

SAC-8P-M 8MR/ 5,0-PUR - Sensor/actuator cable



1404185

<https://www.phoenixcontact.com/us/products/1404185>

Accessories

PROT-M 8 FS-PA-CHAIN - Sealing cap

1430857

<https://www.phoenixcontact.com/us/products/1430857>

M8 sealing cap made of plastic with fixing band for sensor cables, for M8 plugs



UCT-WMT (23X4) - Conductor marker

0801453

<https://www.phoenixcontact.com/us/products/0801453>

Conductor marker, Sheet, white, unlabeled, can be labeled with: TOPMARK NEO, TOPMARK LASER, BLUEMARK ID COLOR, BLUEMARK ID, BLUEMARK CLED, THERMOMARK PRIME, THERMOMARK CARD 2.0, THERMOMARK CARD, mounting type: insert, cable diameter range: 1.5 ... 35 mm, lettering field size: 23 x 4 mm, Number of individual labels: 30



SAC-8P-M 8MR/ 5,0-PUR - Sensor/actuator cable



1404185

<https://www.phoenixcontact.com/us/products/1404185>

UC-WMT (23X4) - Conductor marker

0819411

<https://www.phoenixcontact.com/us/products/0819411>



Conductor marker, Sheet, white, unlabeled, can be labeled with: BLUEMARK ID COLOR, BLUEMARK ID, BLUEMARK CLED, PLOTMARK, CMS-P1-PLOTTER, mounting type: insert, cable diameter range: 1.5 ... 35 mm, lettering field size: 23 x 4 mm, Number of individual labels: 24

US-WMT (23X4) - Cable marker

0828769

<https://www.phoenixcontact.com/us/products/0828769>



Cable marker, Card, white, unlabeled, can be labeled with: BLUEMARK ID COLOR, BLUEMARK ID, THERMOMARK PRIME, THERMOMARK CARD 2.0, THERMOMARK CARD, mounting type: slide-on, cable diameter range: 1.5 ... 35 mm, lettering field size: 23 x 4 mm, Number of individual labels: 56

SAC-8P-M 8MR/ 5,0-PUR - Sensor/actuator cable



1404185

<https://www.phoenixcontact.com/us/products/1404185>

WMTW (23X4)R - Cable marker

0831004

<https://www.phoenixcontact.com/us/products/0831004>



Cable marker, Roll, white, unlabeled, can be labeled with: THERMOMARK E.300 (D)/600 (D), THERMOMARK ROLL 2.0, THERMOMARK ROLL, THERMOMARK ROLL X1, THERMOMARK ROLLMASTER 300/600, THERMOMARK X1.2, mounting type: insert, cable diameter range: 1.5 ... 35 mm, lettering field size: 23 x 4 mm, Number of individual labels: 3000

WP-CTA POM 13,0 BK - Protective hose adapter

1422884

<https://www.phoenixcontact.com/us/products/1422884>



Protective hose adapter, for corrugated hoses with a nominal size of 13 (10 x 13), corrugated in parallel

SAC-8P-M 8MR/ 5,0-PUR - Sensor/actuator cable



1404185

<https://www.phoenixcontact.com/us/products/1404185>

WP-PA HF 13,0 BK - Protective hose

3240681

<https://www.phoenixcontact.com/us/products/3240681>



Protective hose, material: PA 6, UV-resistant: yes, flexible, degree of protection: IP68, color: black, flammability rating in acc. with UL 94: V0, inner diameter: 10 mm, Total length: 50 m

WP-PA HF-HB 13,0 BK - Protective hose

3240839

<https://www.phoenixcontact.com/us/products/3240839>



Protective hose, material: PA 6, UV-resistant: yes, flexible, degree of protection: IP68, color: black, flammability rating in acc. with UL 94: HB, inner diameter: 10 mm, Total length: 50 m

SAC-8P-M 8MR/ 5,0-PUR - Sensor/actuator cable



1404185

<https://www.phoenixcontact.com/us/products/1404185>

TSD 02 SAC - Torque screwdriver

1208487

<https://www.phoenixcontact.com/us/products/1208487>



Torque screwdriver, with preset torque of 0.2 Nm and 4 mm hexagonal drive for M8 connectors

SAC BIT M8-D10 - Tool

1208461

<https://www.phoenixcontact.com/us/products/1208461>



Nut for assembling M8 connectors with longitudinal knurl and a knurl diameter of 10 mm, for 4 mm hexagonal drive

SAC-8P-M 8MR/ 5,0-PUR - Sensor/actuator cable



1404185

<https://www.phoenixcontact.com/us/products/1404185>

B-STIFT - Marker pen

1051993

<https://www.phoenixcontact.com/us/products/1051993>



Marker pen, for manual labeling of unprinted Zack strips, smear-proof and waterproof, line thickness 0.5 mm

CUTFOX-S VDE - Diagonal cutter

1212207

<https://www.phoenixcontact.com/us/products/1212207>



Diagonal cutter for hard (piano wire) and soft wires, VDE 1000 V AC/1500 V DC tested

SAC-8P-M 8MR/ 5,0-PUR - Sensor/actuator cable



1404185

<https://www.phoenixcontact.com/us/products/1404185>

WIREFOX SAC-1 - Stripping tool

1212757

<https://www.phoenixcontact.com/us/products/1212757>



Stripping pliers, for halogen-free sensor/actuator cables (SAC cables), with PUR and PVC insulation, from Ø of 3.2 to 4.4 mm, any stripping length

WIREFOX SAC - Stripping tool

1212623

<https://www.phoenixcontact.com/us/products/1212623>



Stripping pliers, for halogen-free sensor/actuator cables (SAC cables), with PUR and PVC insulation, from Ø of 4.4 to 7 mm, any stripping length

SAC-8P-M 8MR/ 5,0-PUR - Sensor/actuator cable



1404185

<https://www.phoenixcontact.com/us/products/1404185>

WIREFOX 10 - Stripping tool

1212150

<https://www.phoenixcontact.com/us/products/1212150>



Stripping tool, for cables and conductors from 0.02 - 10 mm², self-adjusting, stripping length of up to 18 mm, cutting capacity of up to 10 mm² stranded/1.5 mm² solid, replaceable stripping blade

Phoenix Contact 2024 © - all rights reserved

<https://www.phoenixcontact.com>

Phoenix Contact USA
586 Fulling Mill Road
Middletown, PA 17057, United States
(+717) 944-1300
info@phoenixcon.com